

3 1761 07825110 5





DAVID JARDINE JARDINE



Digitized by the Internet Archive
in 2010 with funding from
University of Toronto

CYCLOPÆDIA

THE

CYCLOPÆDIA;

OR,

Universal Dictionary

OF

ARTS, SCIENCES, AND LITERATURE.

PLATES. VOL. IV.

NAVIGATION — WRITING BY CIPHER.

THE
CYCLOPEDIA;
OR
Universal Dictionary
OF
ARTS, SCIENCES, AND LITERATURE.
PLATES FOR THE
NAVIGATION — WRITING BY CHURCH.

THE
CYCLOPÆDIA;

OR,

UNIVERSAL DICTIONARY

OF

Arts, Sciences, and Literature.

BY

ABRAHAM REES, D.D. F.R.S. F.L.S. *S. Amer. Soc.*

WITH THE ASSISTANCE OF

EMINENT PROFESSIONAL GENTLEMEN.

ILLUSTRATED WITH NUMEROUS ENGRAVINGS,

BY THE MOST DISTINGUISHED ARTISTS.

PLATES. VOL. IV.

NAVIGATION — WRITING BY CIPHER.

LONDON:

PRINTED FOR LONGMAN, HURST, REES, ORME, & BROWN, PATERNOSTER-ROW,
F.C. AND J. RIVINGTON, A. STRAHAN, PAYNE AND FOSS, SCATCHERD AND LETTERMAN, J. CUTHELL,
CLARKE AND SONS, LACKINGTON HUGHES HARDING MAJOR AND JONES, J. AND A. ARCH,
CADELL AND DAVIES, S. BAGSTER, J. MAWMAN, BLACK KINGSBURY PARBURY AND ALLEN,
R. SCHOLEY, J. BOOTH, J. BOOKER, SUTTABY EVANCE AND FOX, BALDWIN CRADOCK AND JOY,
SHERWOOD NEELY AND JONES, OGLE DUNCAN AND CO., R. SAUNDERS, HURST ROBINSON AND CO.,
J. DICKINSON, J. PATERSON, E. WHITESIDE, WILSON AND SONS, AND BRODIE AND DOWDING.

1820.

THE
CYCLOPEDIA;

UNIVERSAL DICTIONARY

Of Arts, Sciences, and Literature.

BY
ABRAHAM REES, D.D. F.R.S. & F.R.S.E.



AE
5
R 329
Plates
v.4

1016084

MERIDIAN

MERIDIONAL parts

TIDE

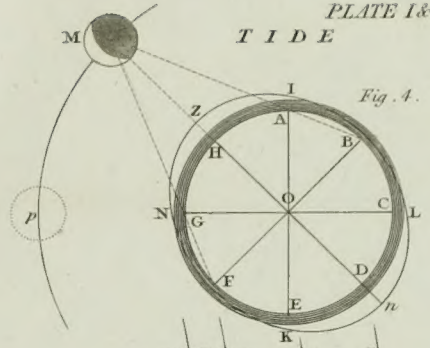
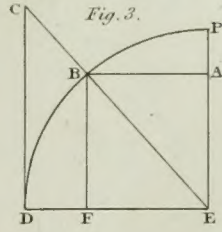
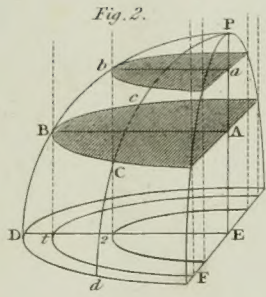
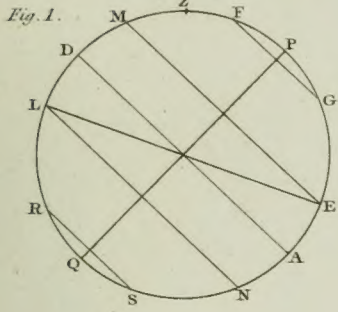
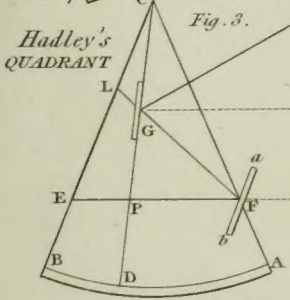
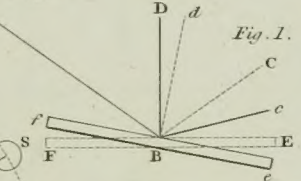
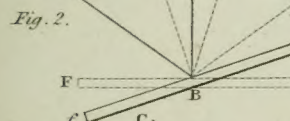
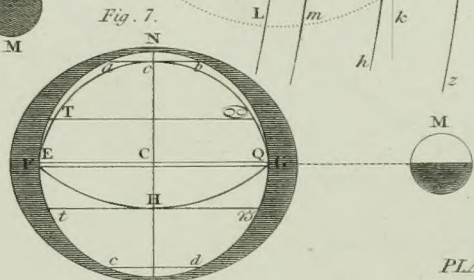
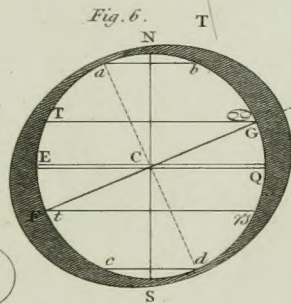
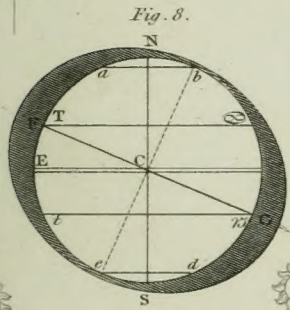
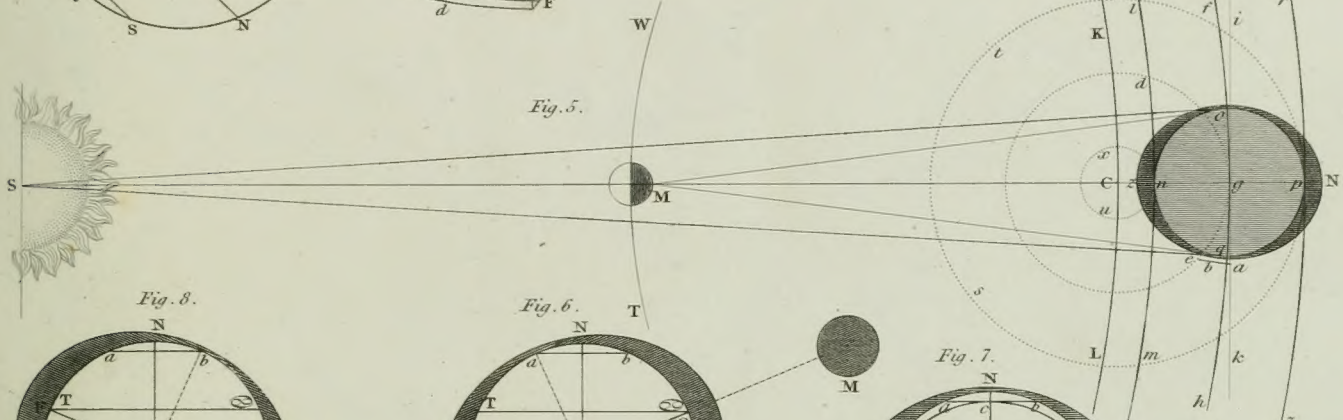
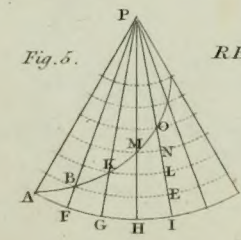
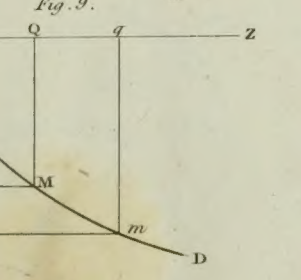
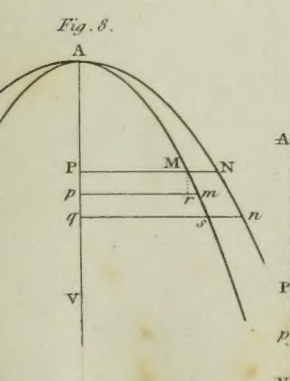
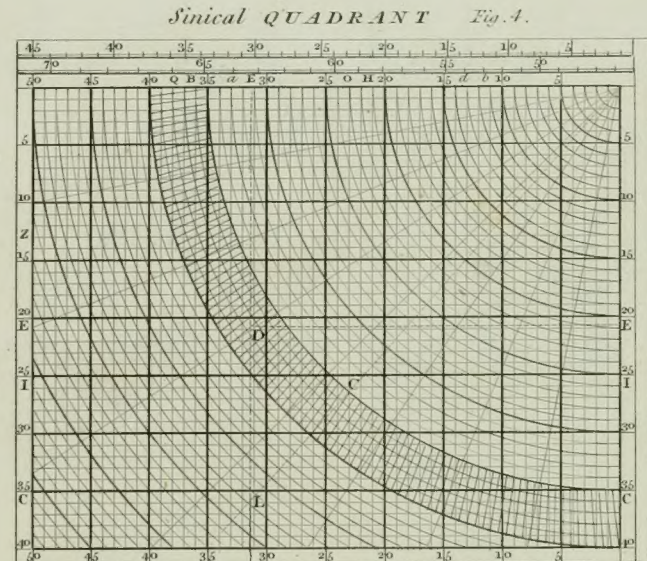
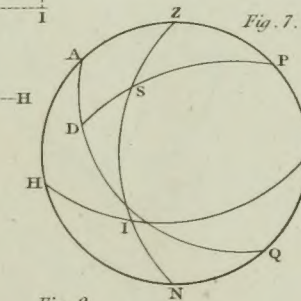

Fig. 5.



VARIATION



RHUMB Line

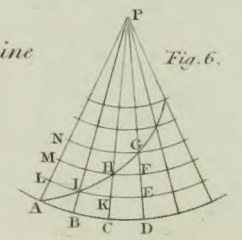

NAVIGATION
RUDDER AND SAILING.

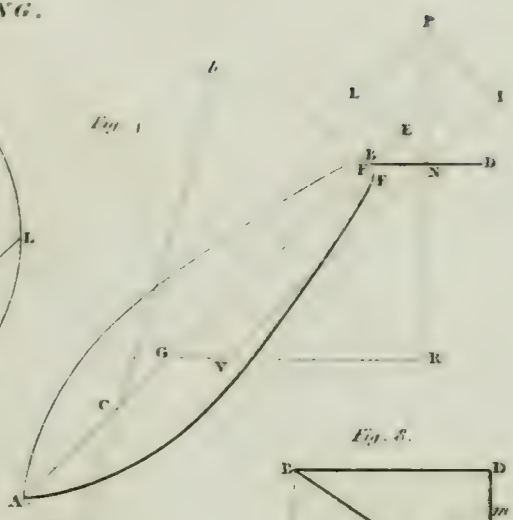
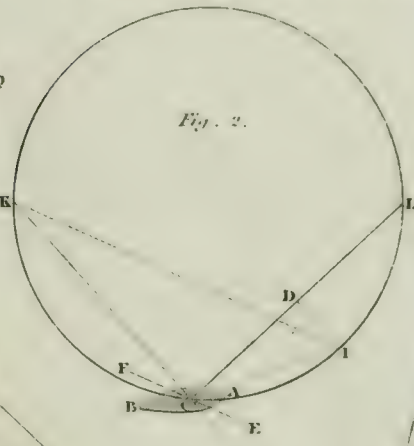
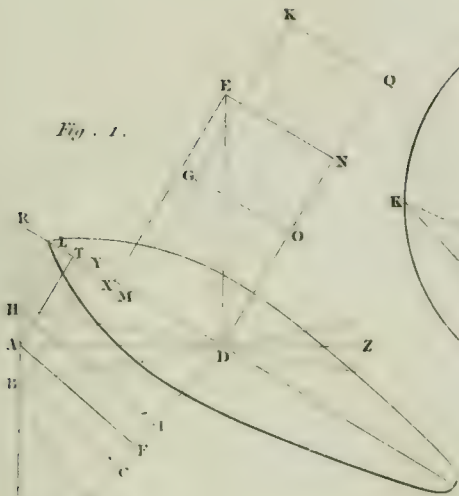

Plain SAILING.

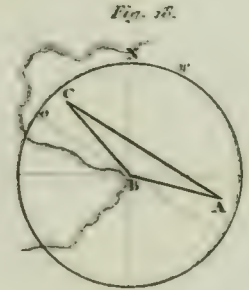
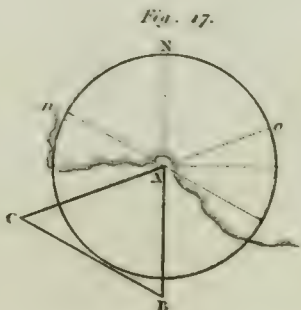
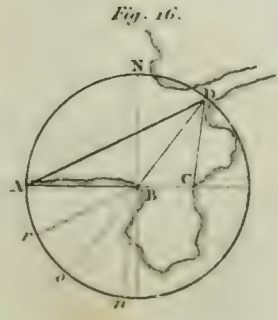
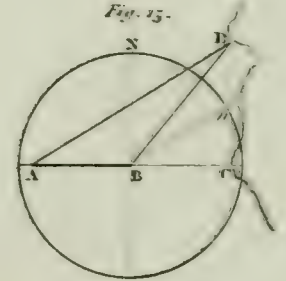
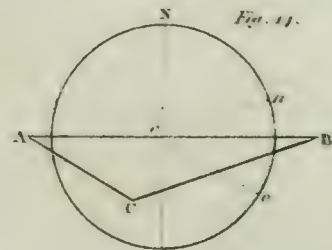
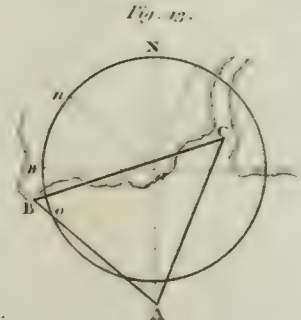
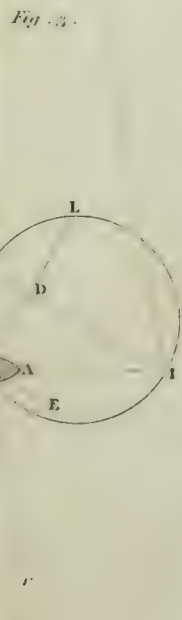
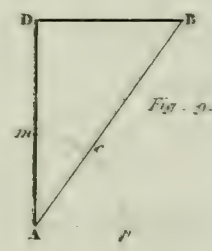
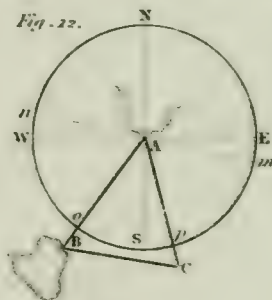
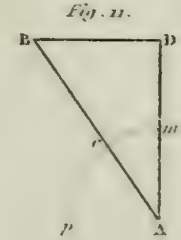
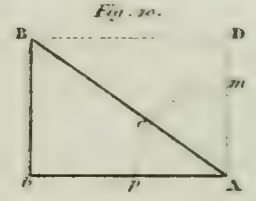
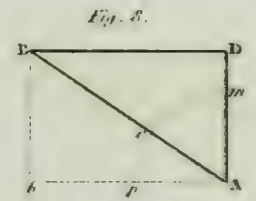
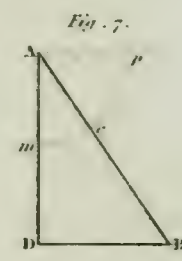
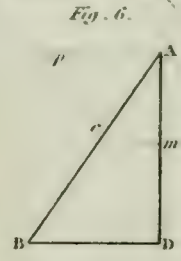
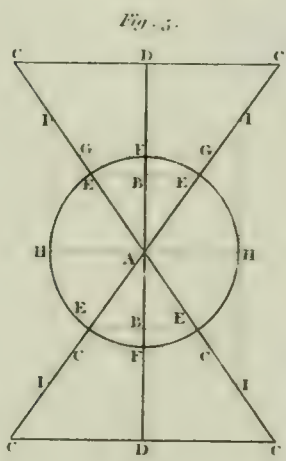

Plain SAILING.

Parallel SAILING.

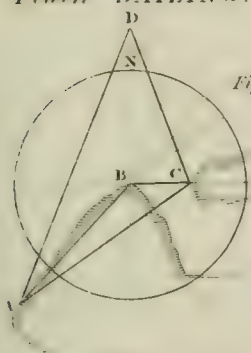

Fig. 19.

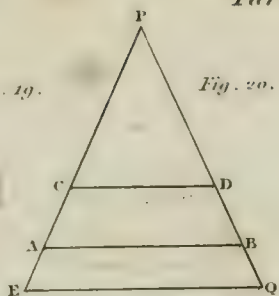

Fig. 20.

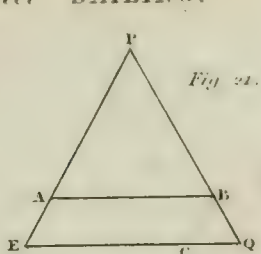

Fig. 21.

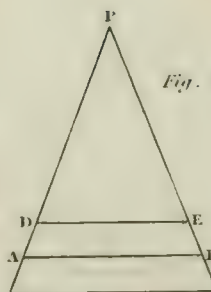

Fig. 22.

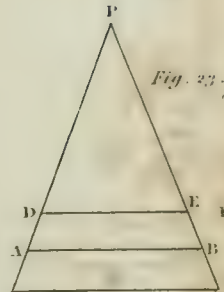

Fig. 23.

Mercators SAILING.

Great Circle SAILING.

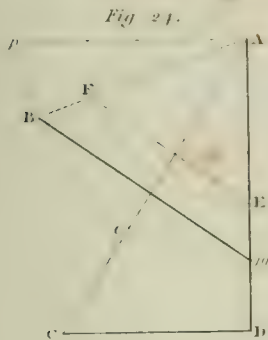

Fig. 24.

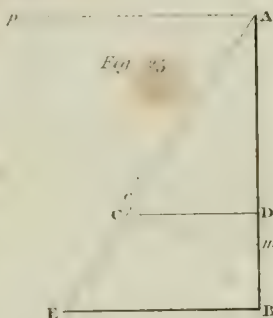

Fig. 25.

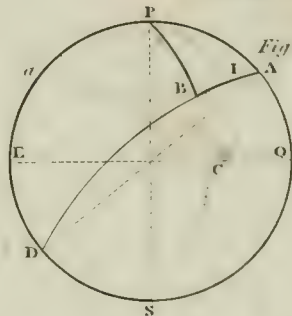

Fig. 26.

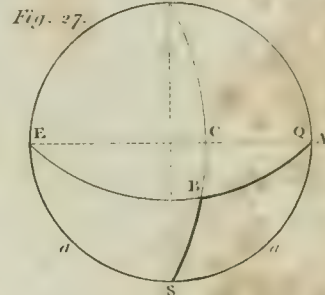

Fig. 27.

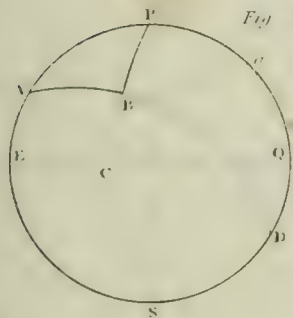

Fig. 28.

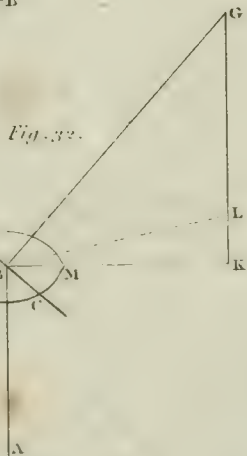

Fig. 29.

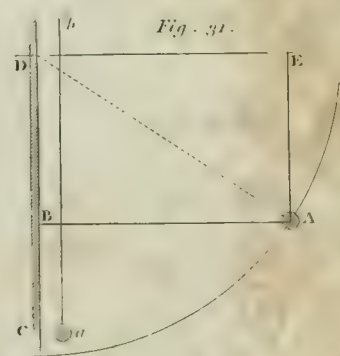

Fig. 30.

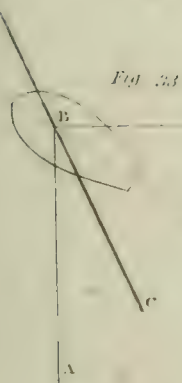

Fig. 31.

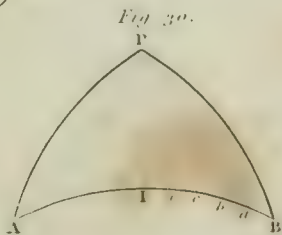

Fig. 32.

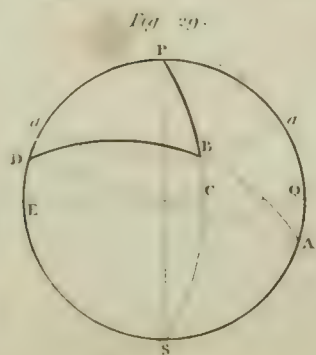

Fig. 33.



Fig. 34.



Fig. 1.

TRAVERSE SAILING

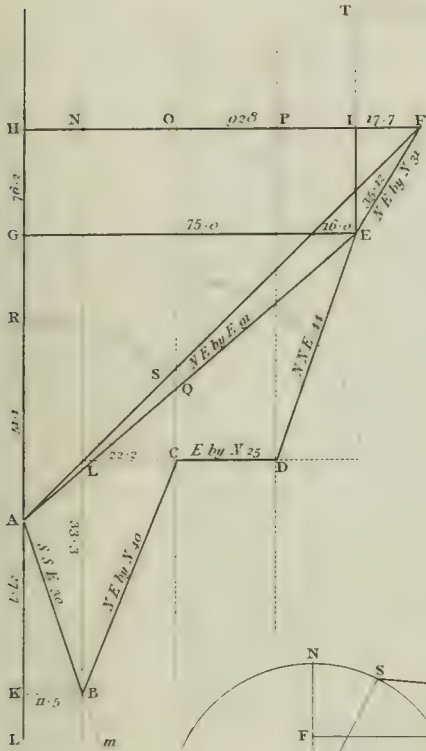
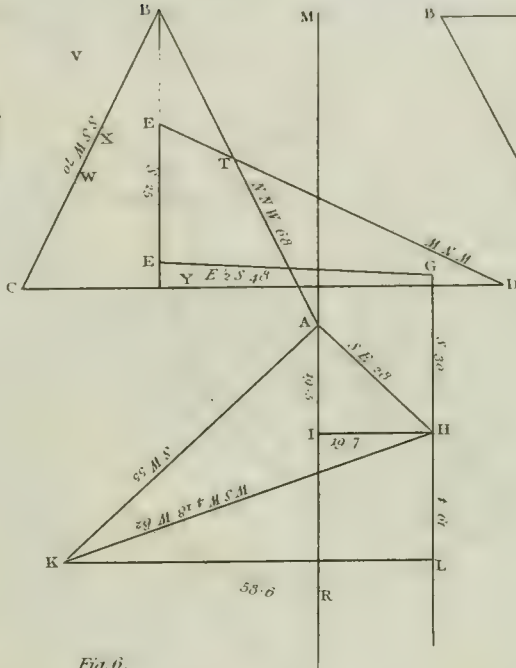

Fig. 2.



CURRENT SAILING

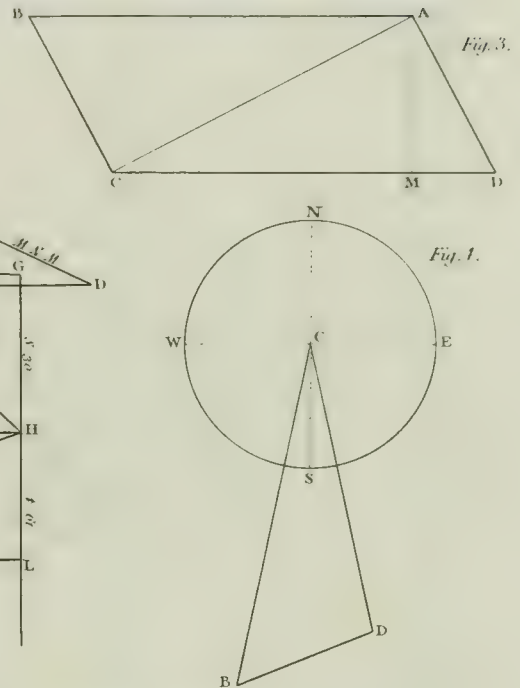

Fig. 6.

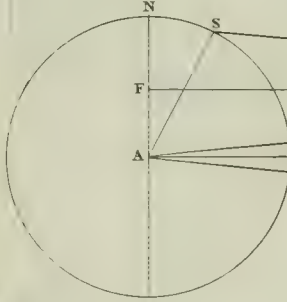
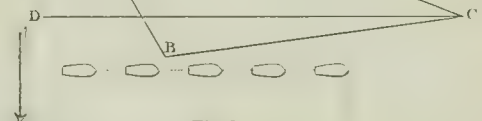
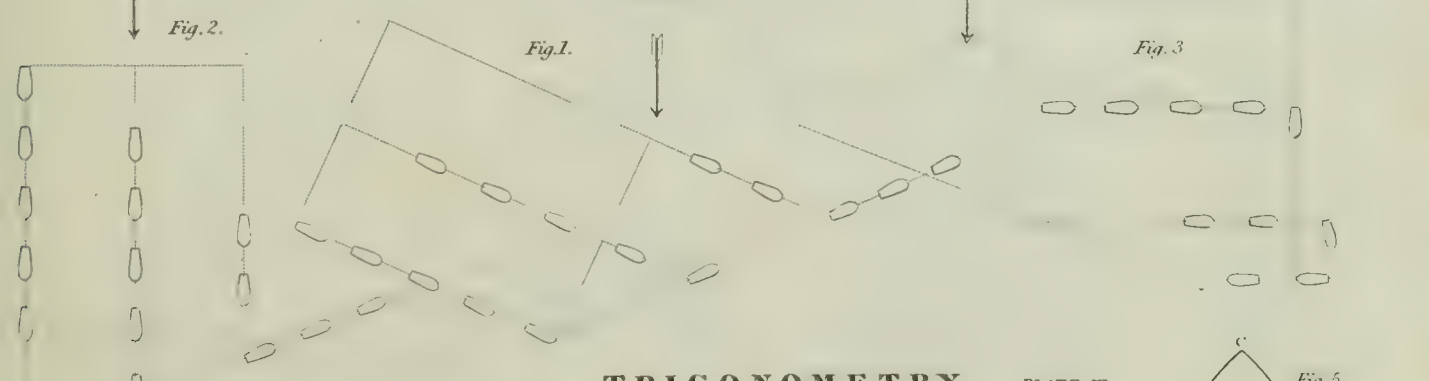

Fig. 5.



NAVAL TACTICS CONVOY



TRIGONOMETRY

PLATE III.

Fig. 1.

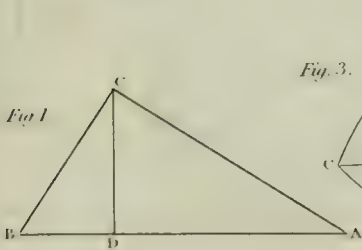

Fig. 3.

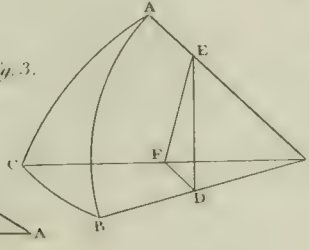

Fig. 2.

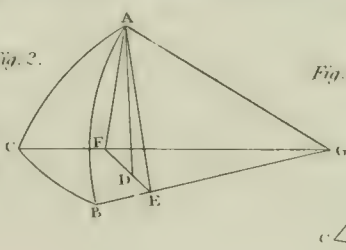

Fig. 4.

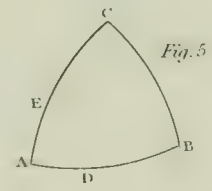
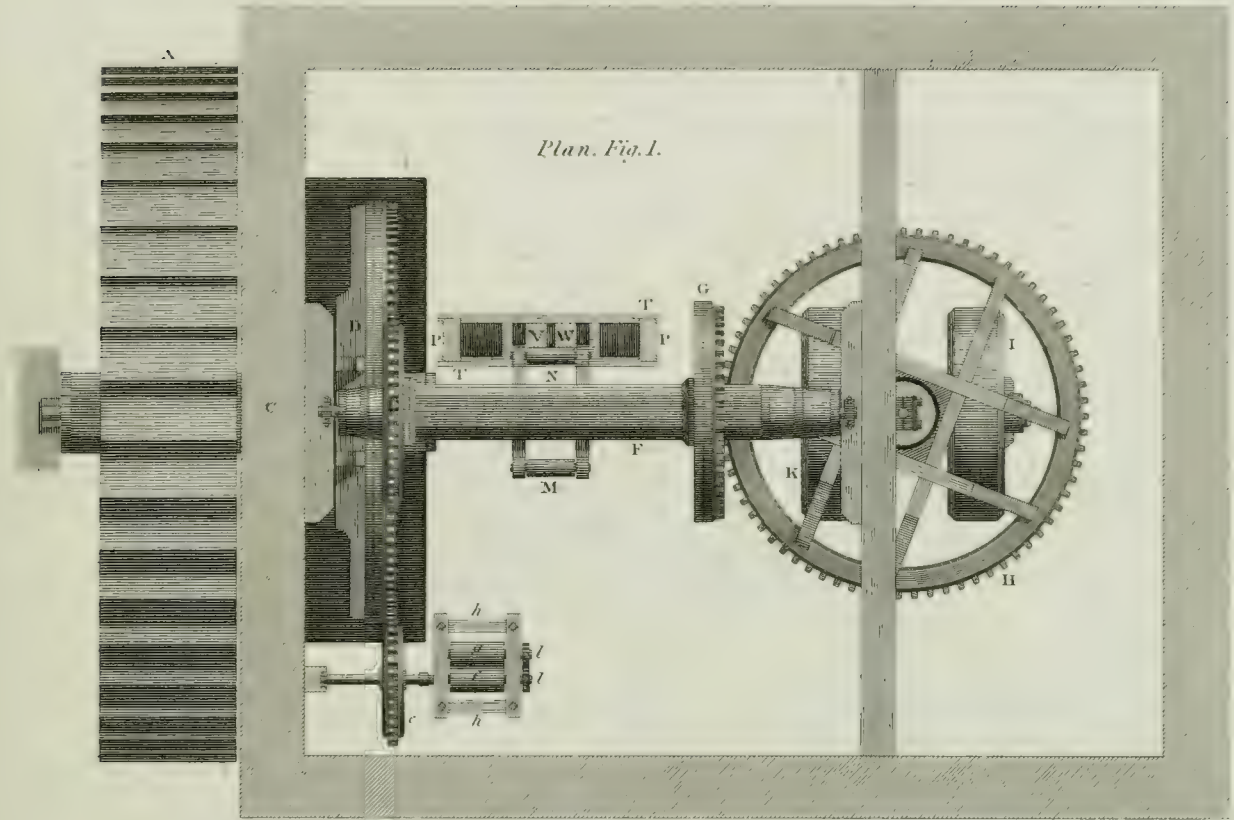

Fig. 5.

OIL MILL.
 BY MR SMEATON.

Plan, Fig. 1.



Elevation, Fig. 2.

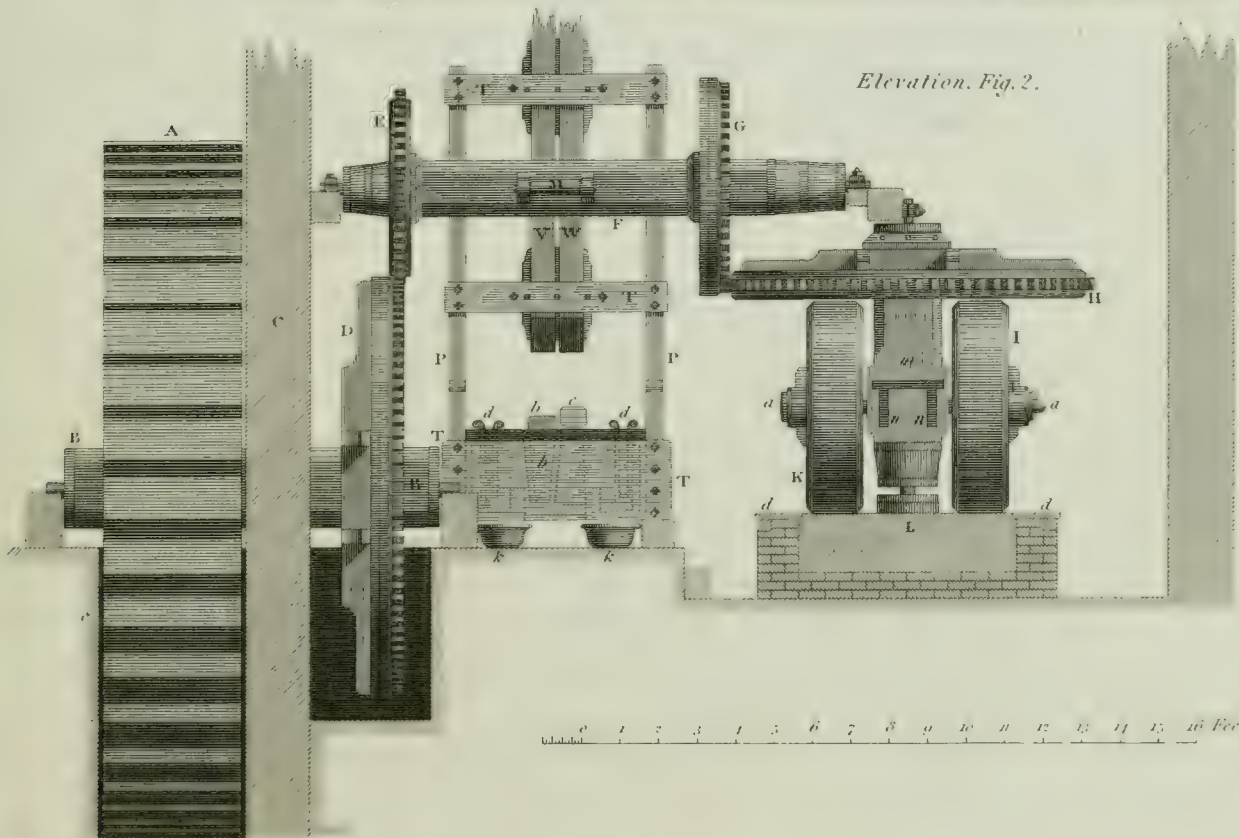

0 1 2 3 4 5 6 7 8 9 10 11 12 13 14 15 16 Feet.



ABBERATION.

ANGLE.

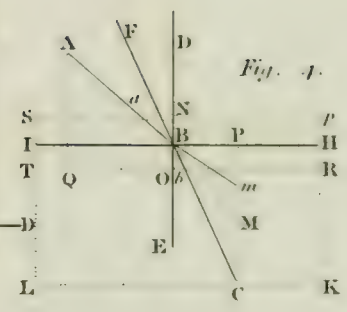
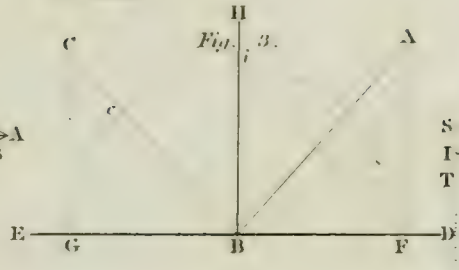
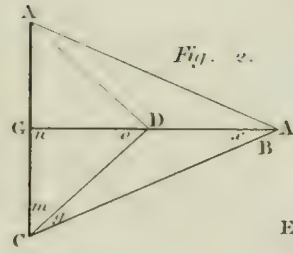
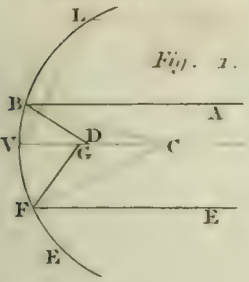

BURROUGHS'S MACHINE, from a MODEL of the SOCIETY of ARTS, &c.
Fig. 5.

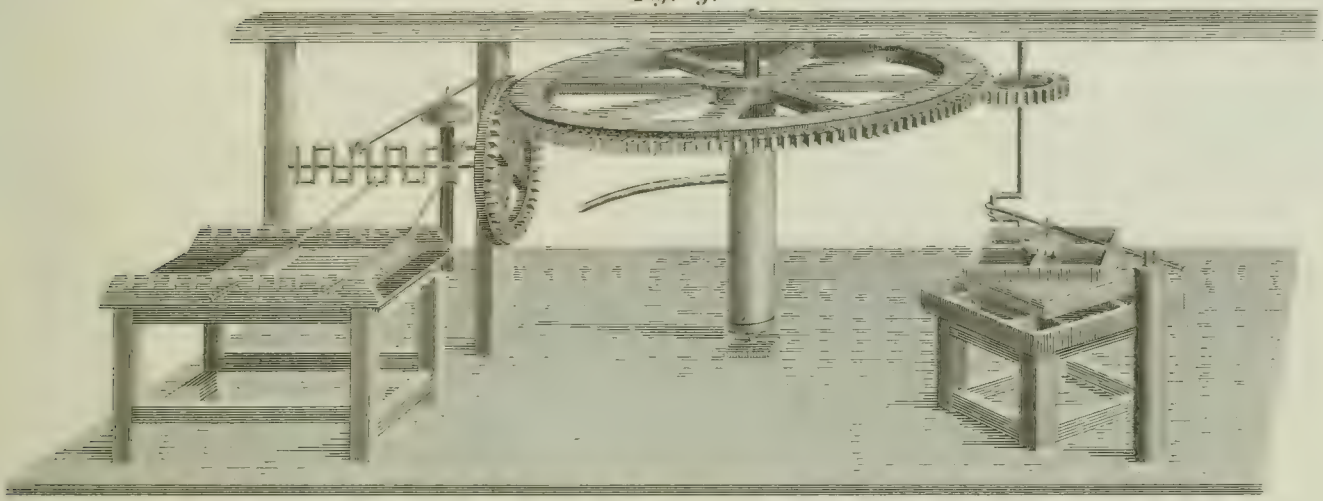

PLAN

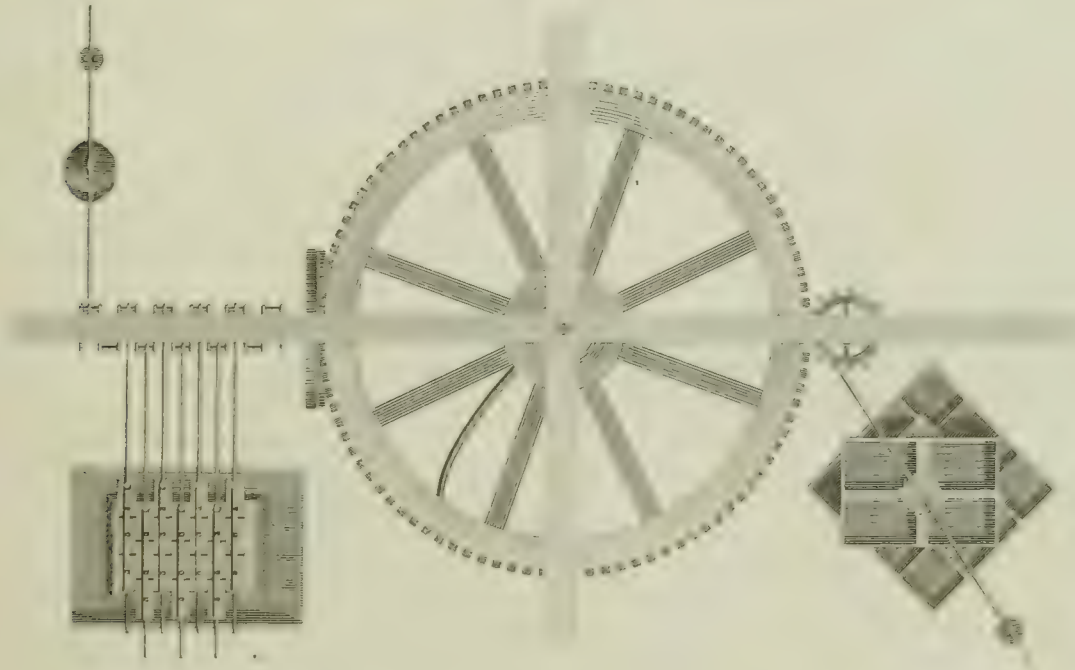

PARKER'S BURNING LENS.

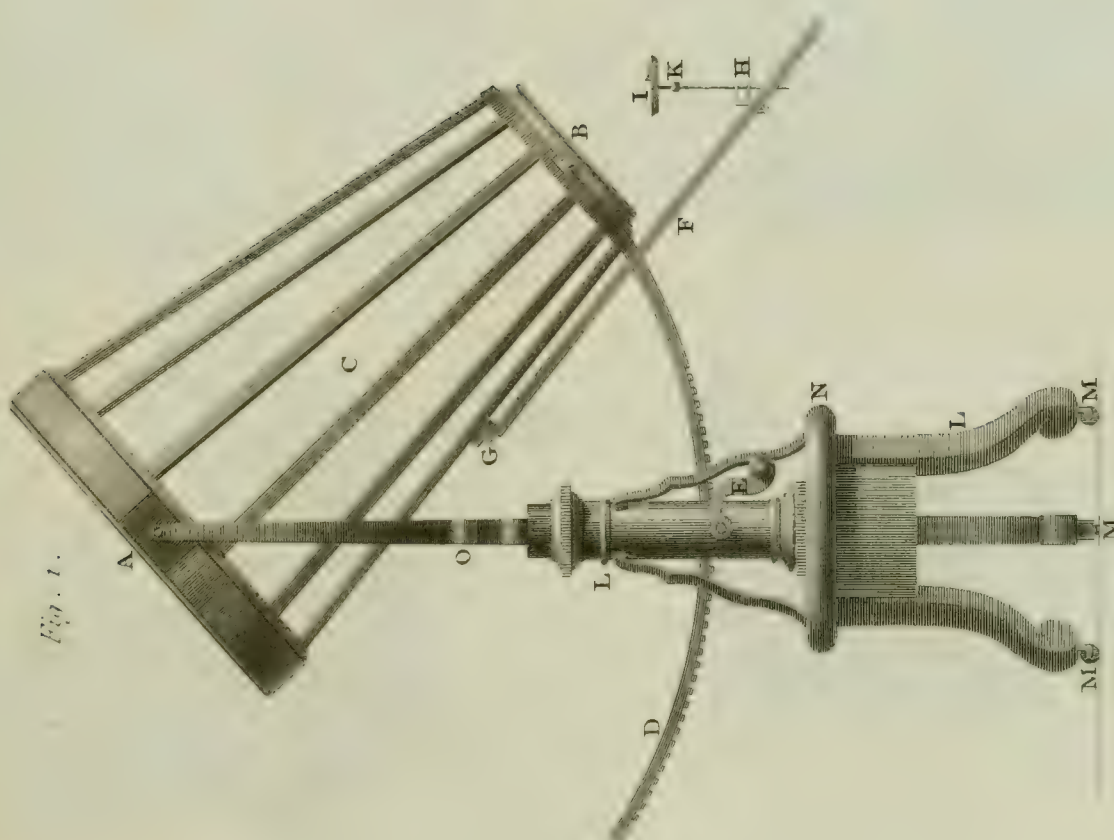

Fig. 1.

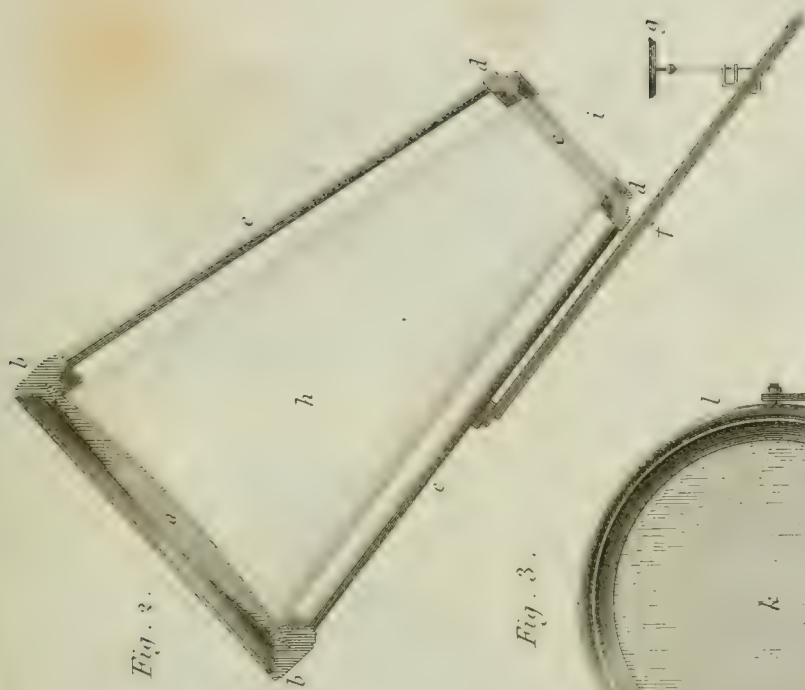
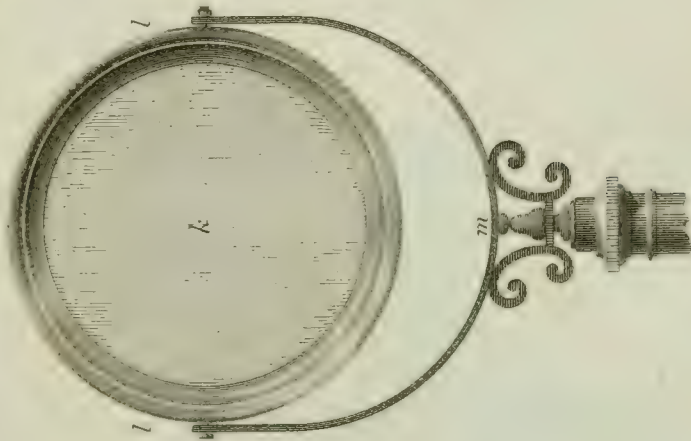

Fig. 2.

Fig. 3.



OPTICS.
CAMERA OBSCURA.

Fig. 1.

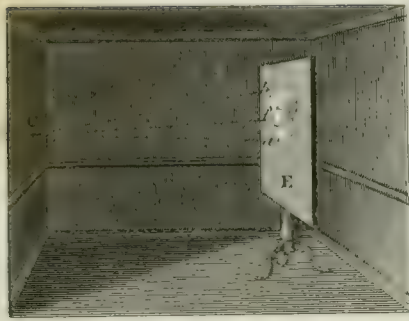

Fig. 2.

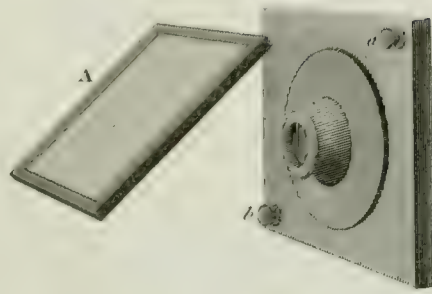

Fig. 3.

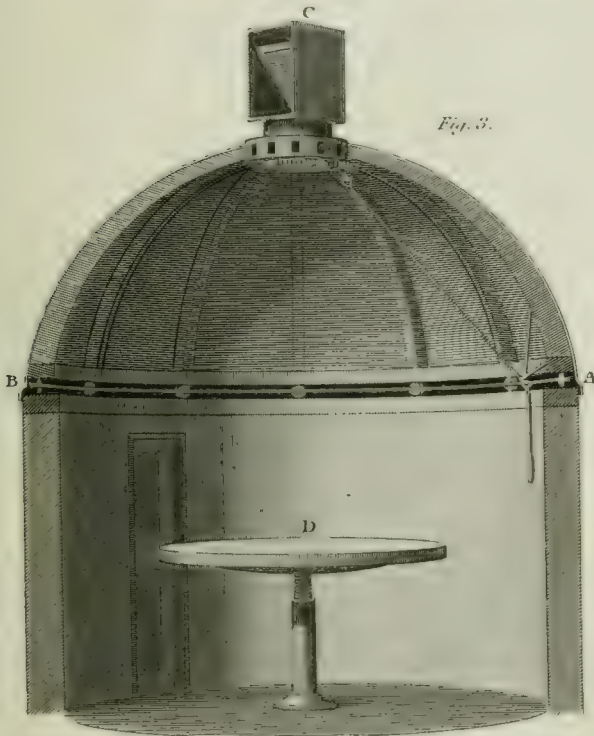

Fig. 4.

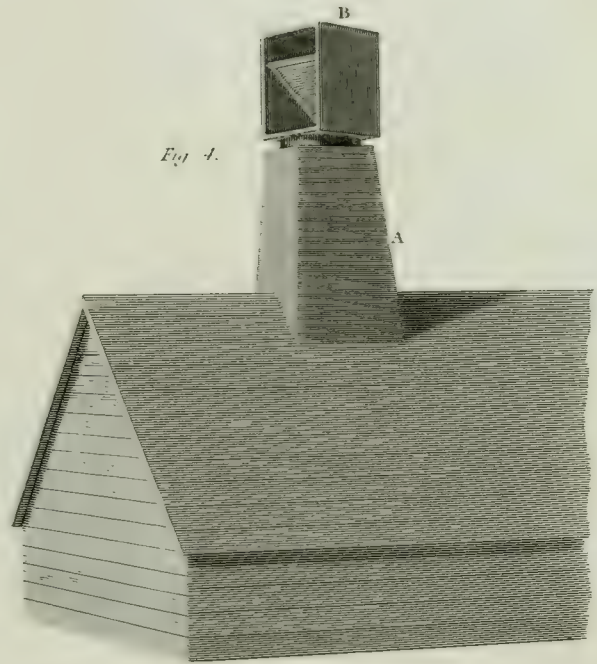

Fig. 5.

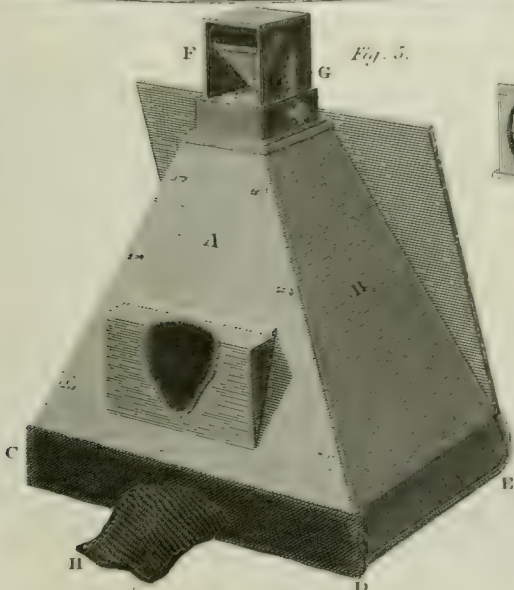

Fig. 6.

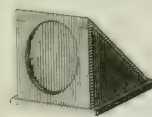
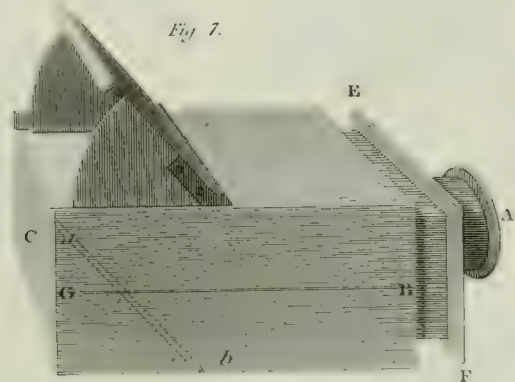
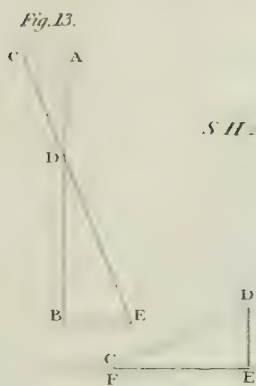
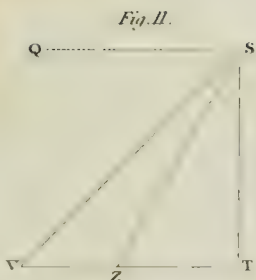
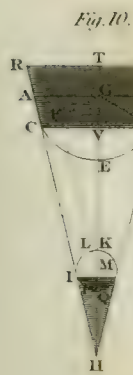

Fig. 7.





SHADOW

Fig. 12.



VISIBLE

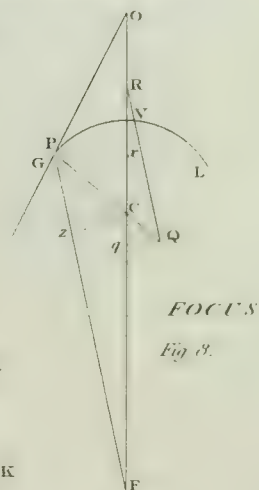
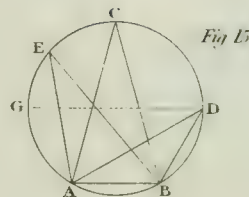
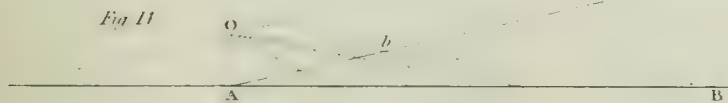

FOCUS

VISION

DIOPTRICS

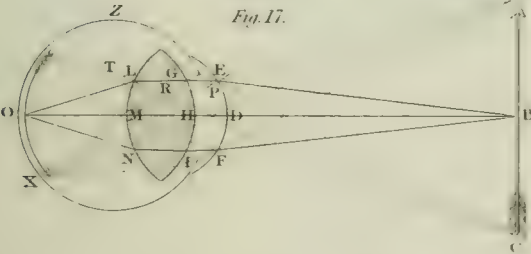

Fig. 2.

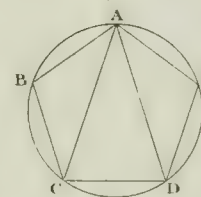
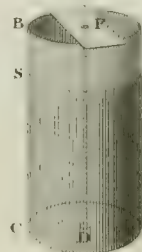

Fig. 10.



LOOKING GLASS

DIOPTRICS

Fig. 3.

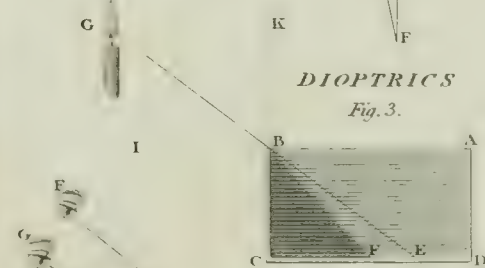
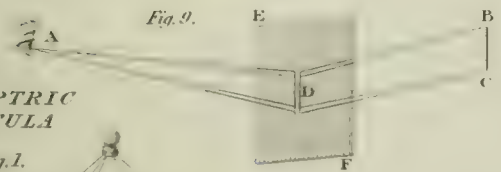
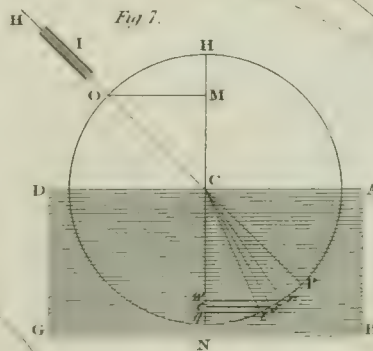
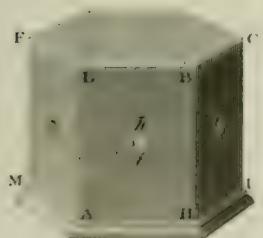
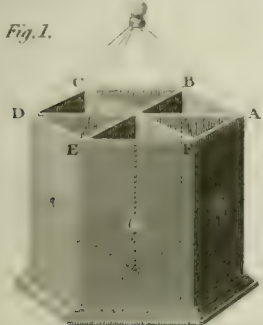

Fig. 1.

CATOPTRIC CISTULA

CATOPTRICS and DIOPTRICS



DISPERSION of Light

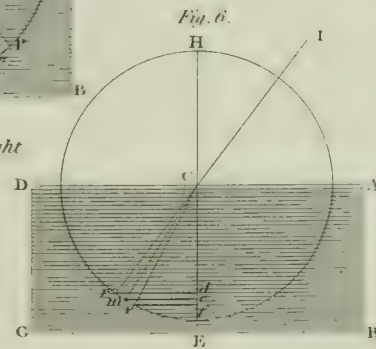
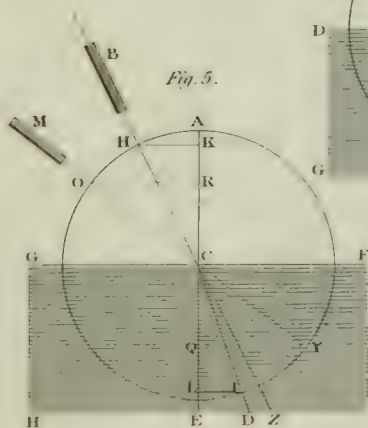

GRINDING.

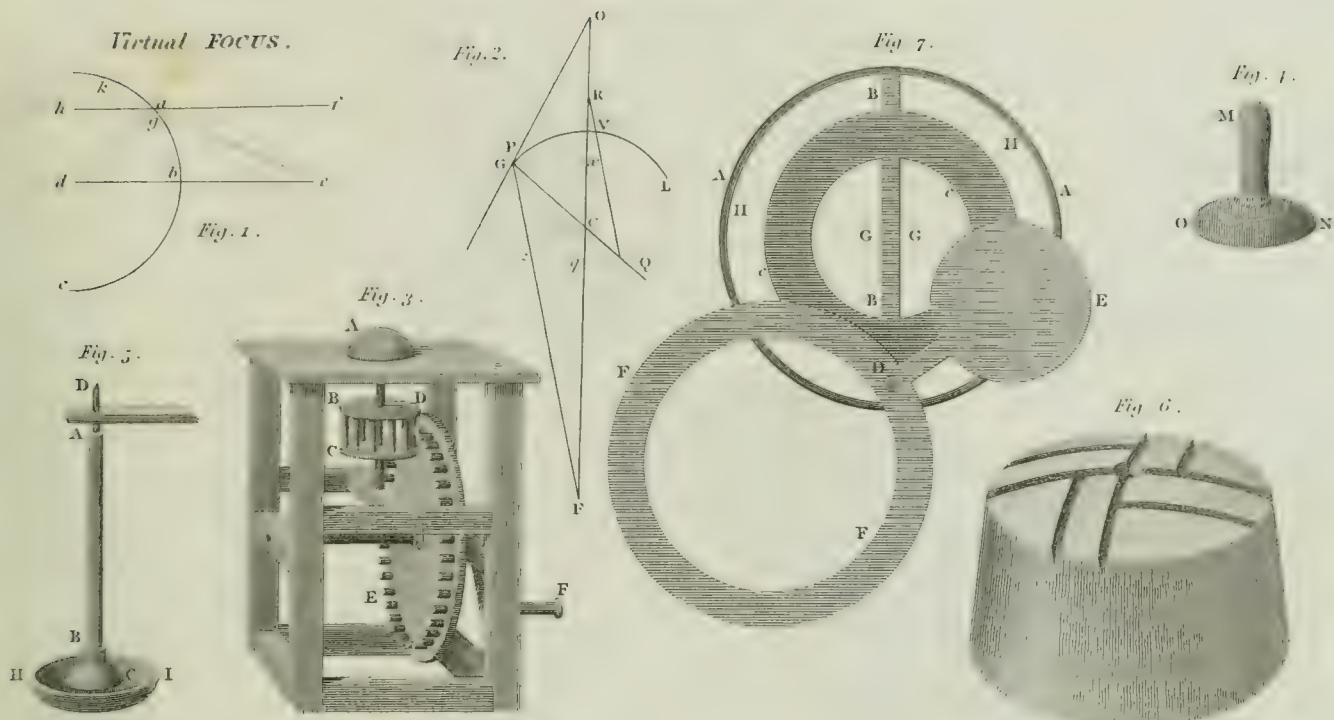

OPTICS.

LENS.

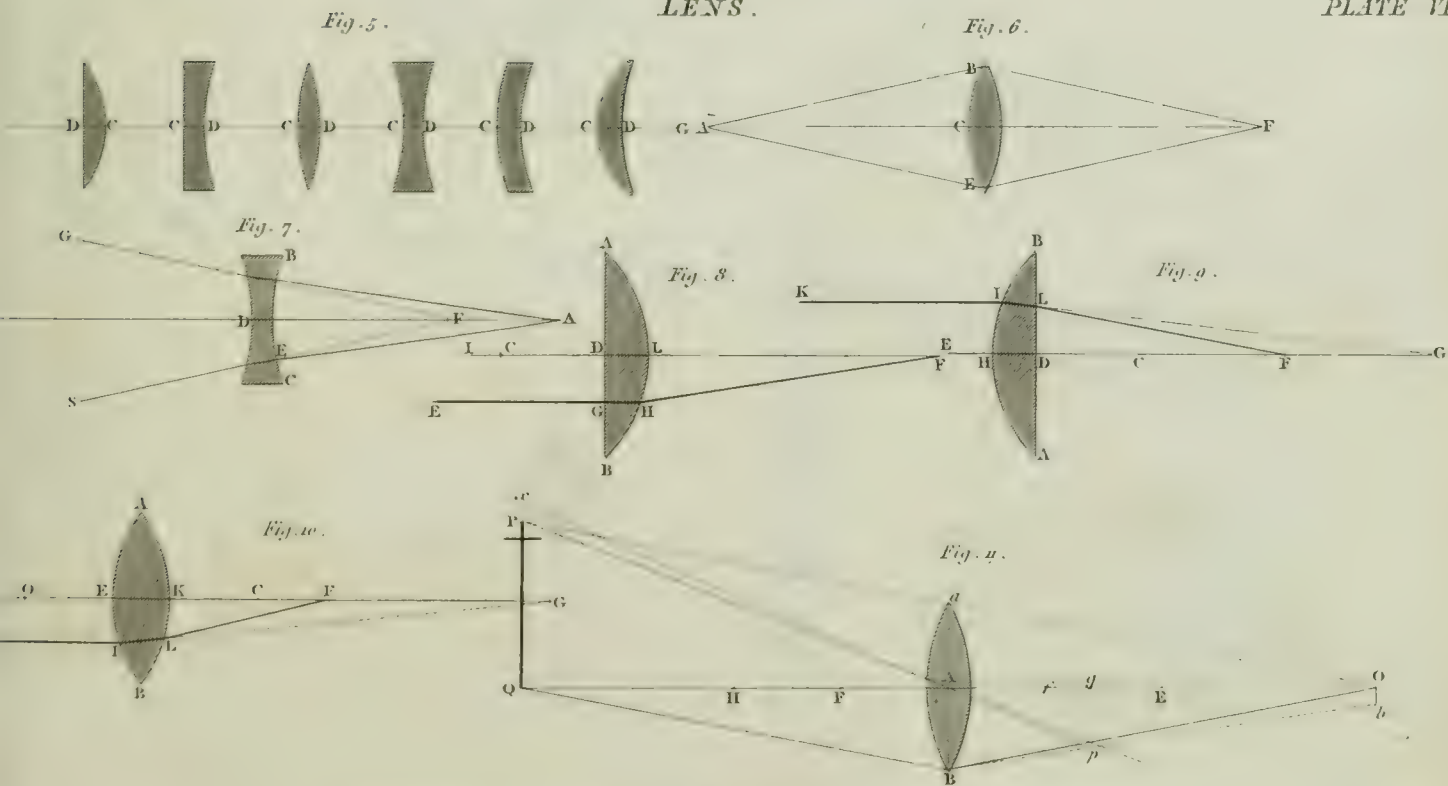

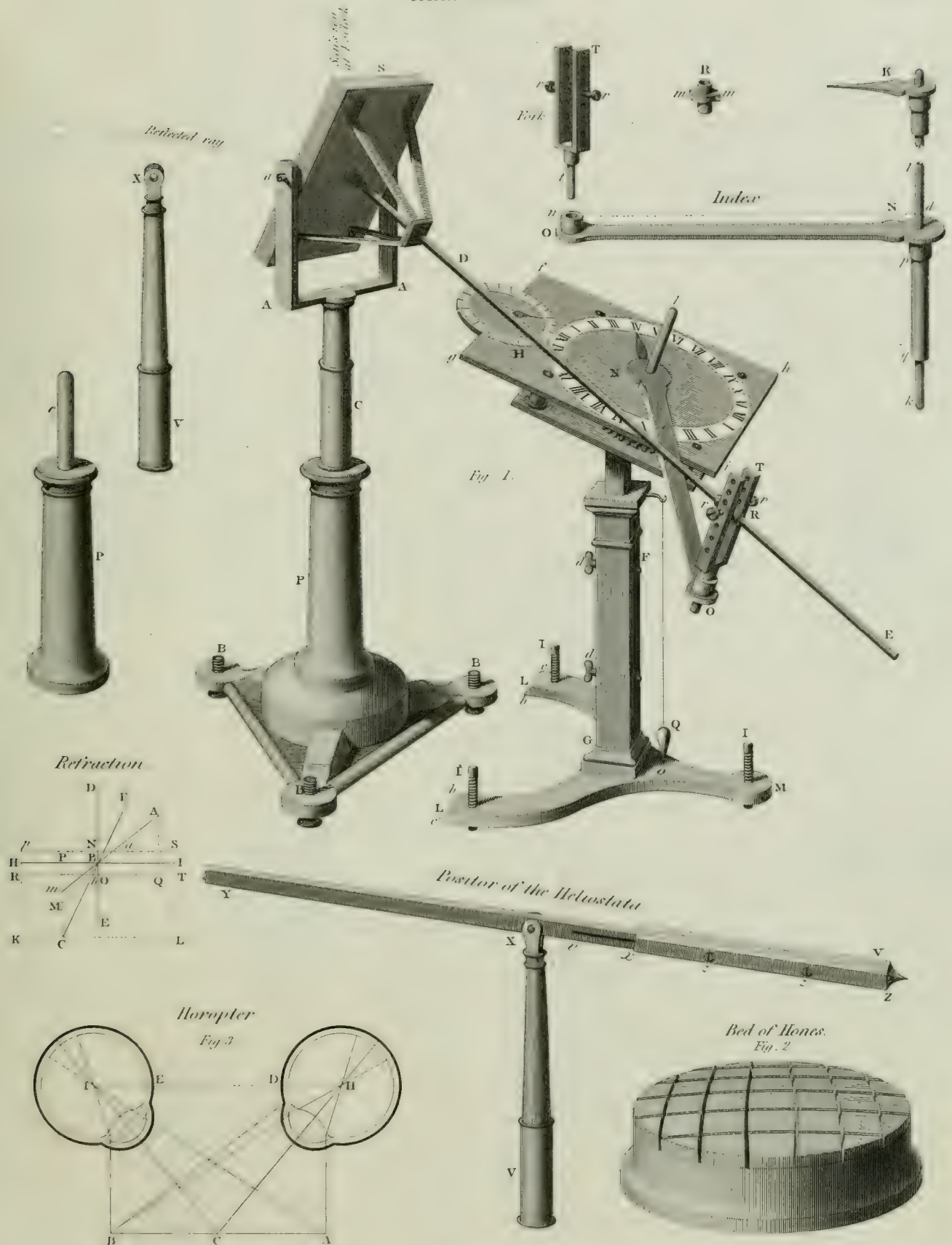

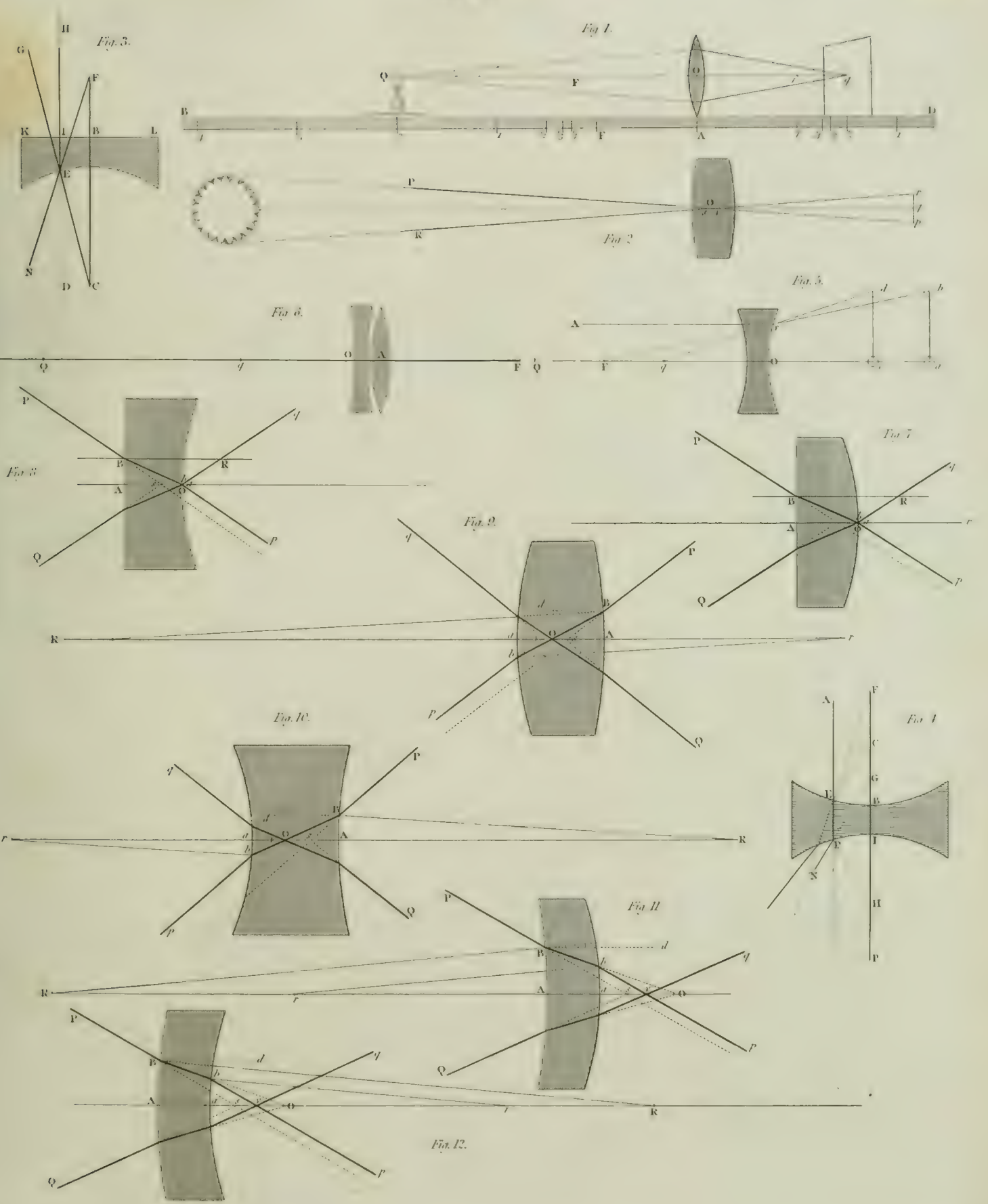

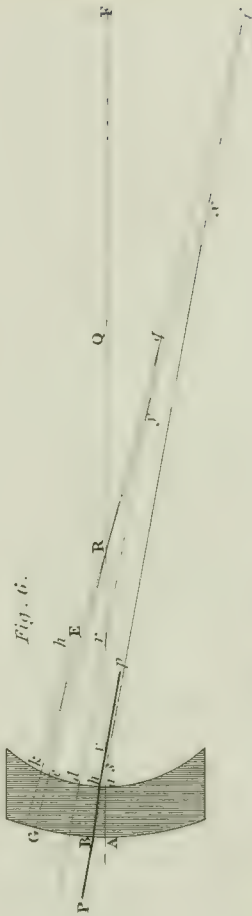
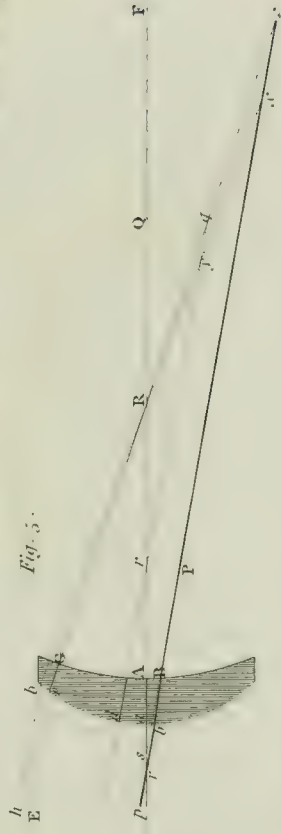
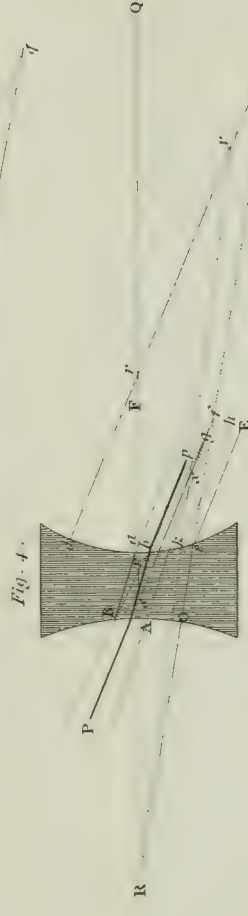
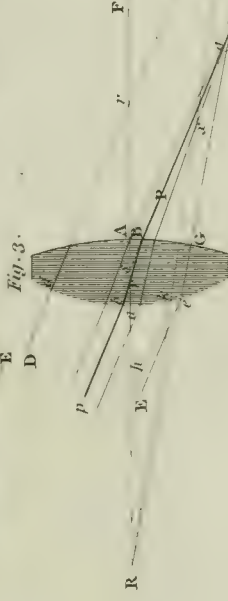
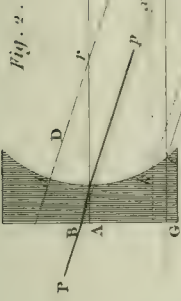
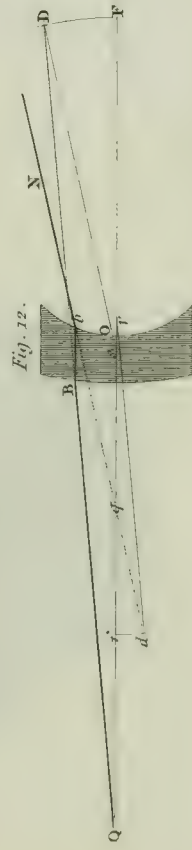
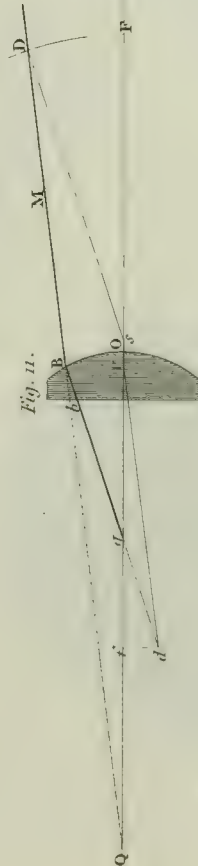
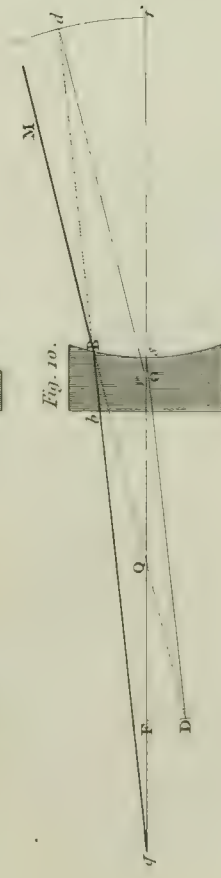
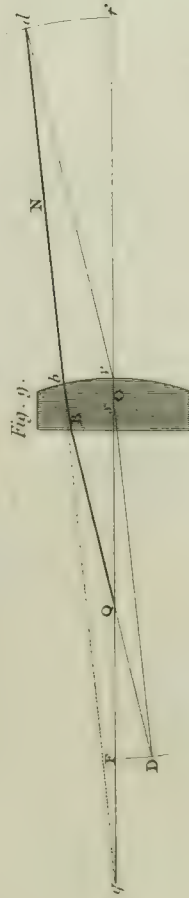
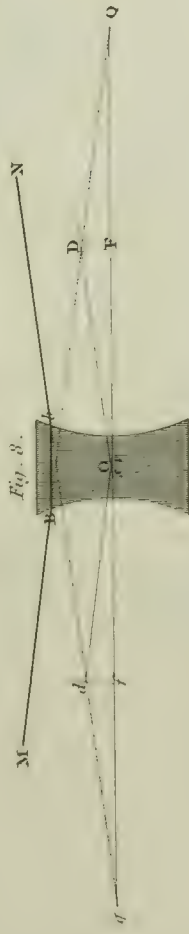
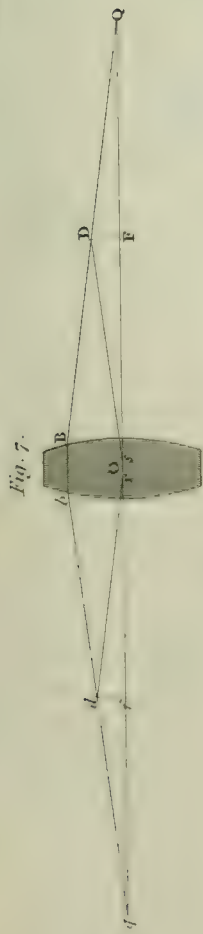

Fig. 1.

Fig. 3.

Fig. 4.

Fig. 5.

Fig. 6.

Fig. 7.

Fig. 8.

Fig. 9.

Fig. 10.

Fig. 11.

Fig. 12.



Fig. 1.

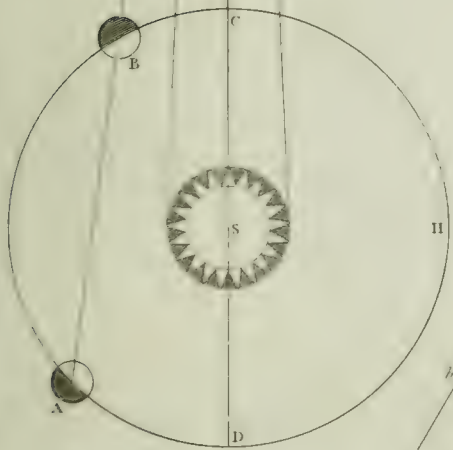

Fig. 2.

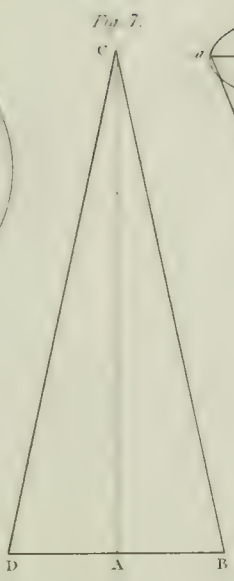

Fig. 3.

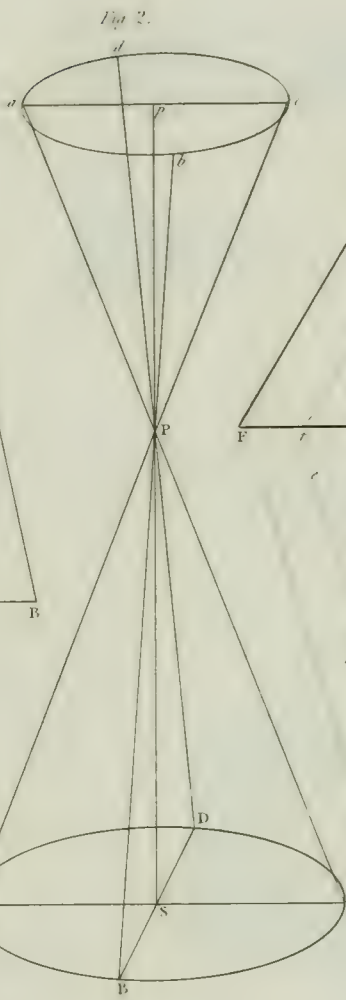

Fig. 4.

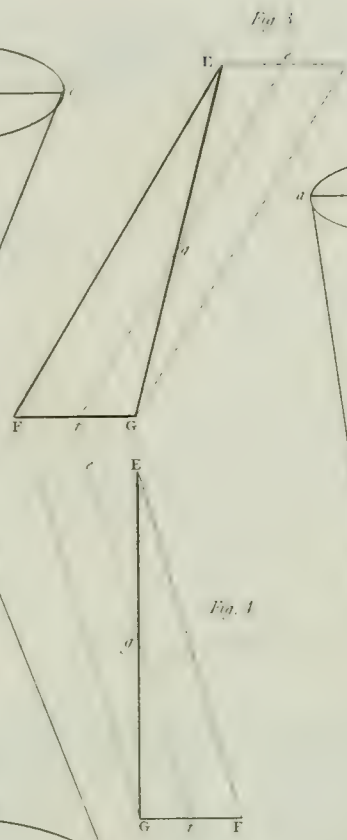

Fig. 5.

Fig. 6.

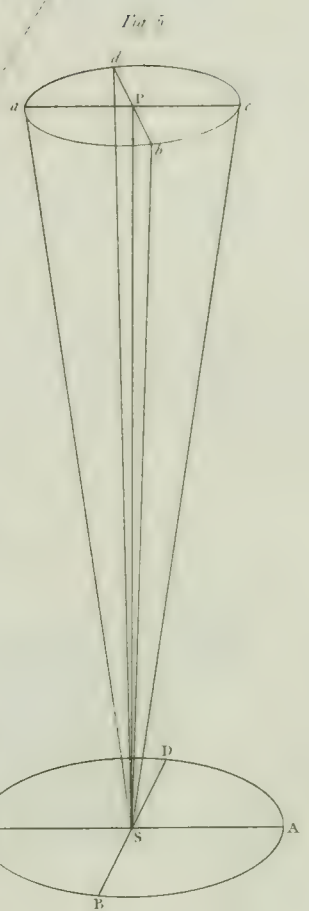

Fig. 7.

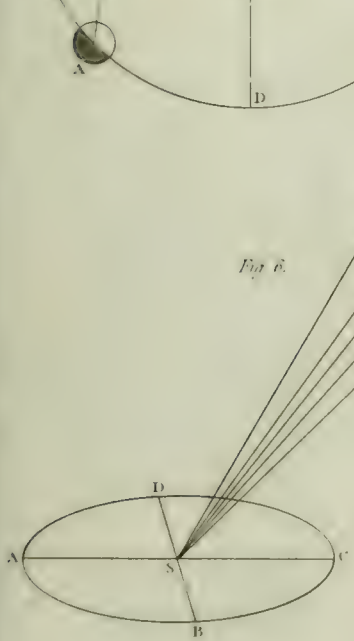

Fig. 8.

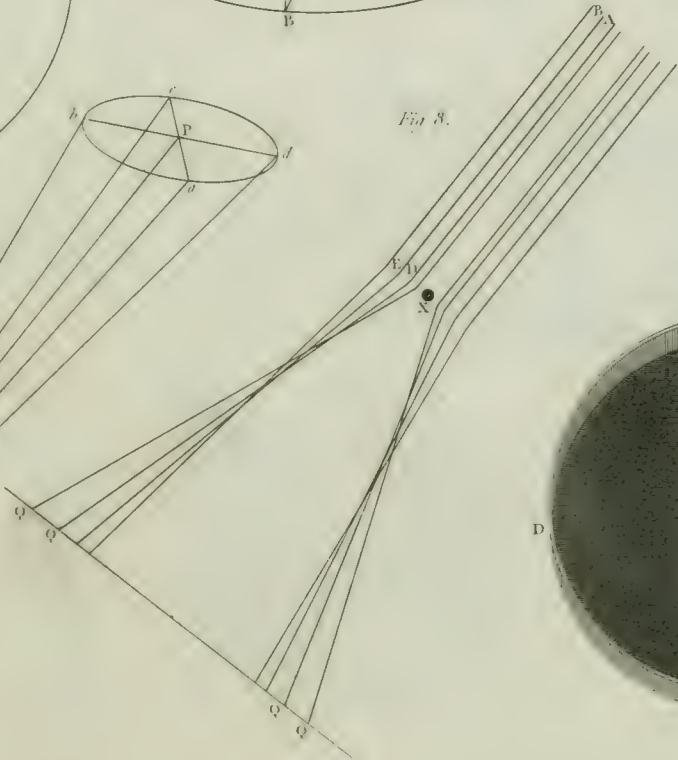

Fig. 9.

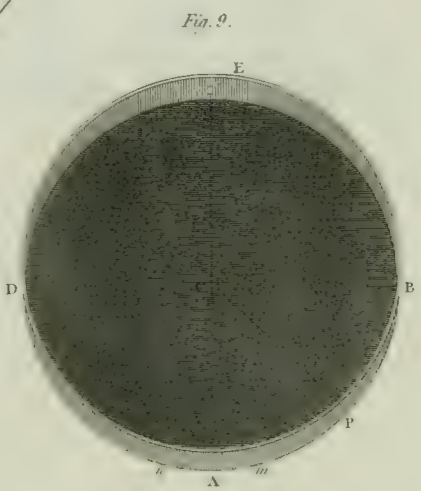

Fig. 10.

Fig. 1.

Magic Lantern.

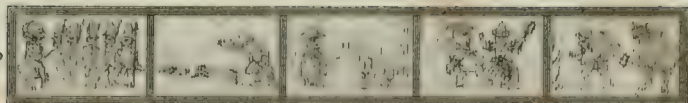
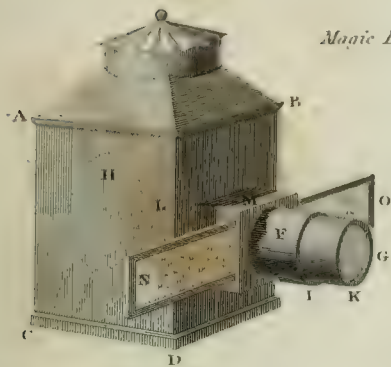
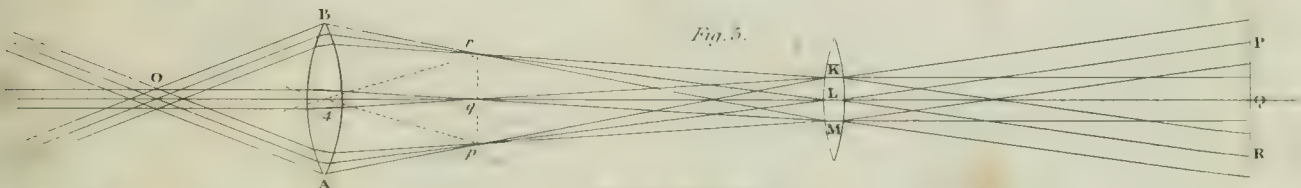

Fig. 2.

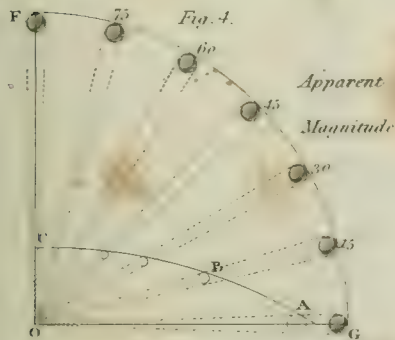

Fig. 3.



MICROMETER.

Fig. 4.



Apparent Magnitude

Fig. 5.

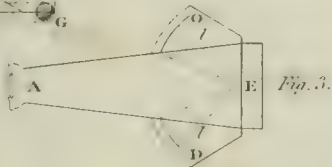
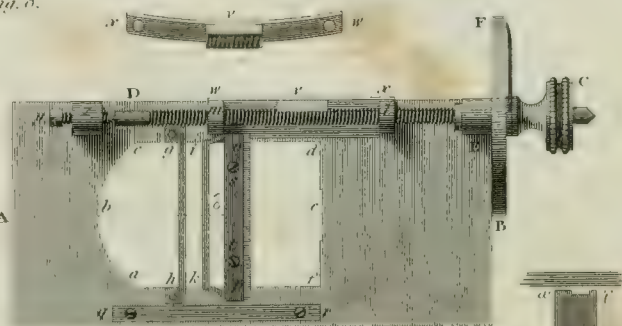

Fig. 8.

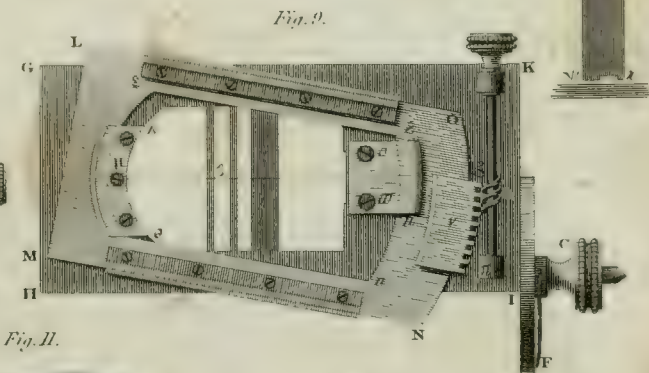

Fig. 9.

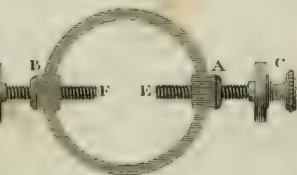
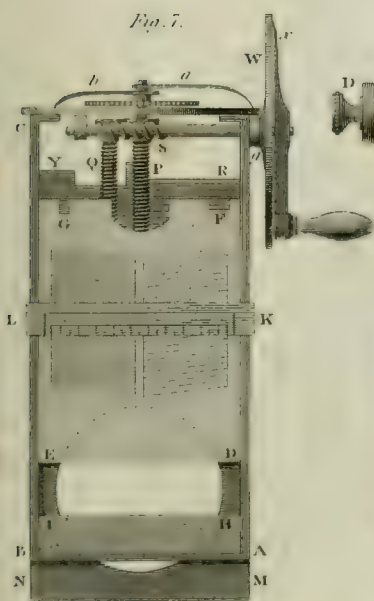

Fig. 11.

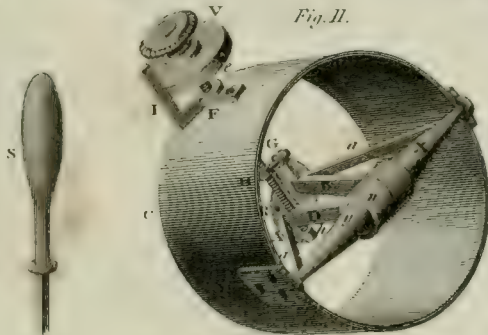
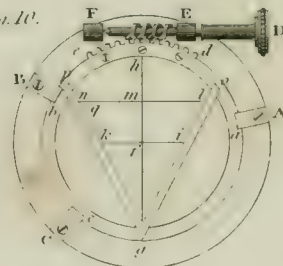

Fig. 12.





MICROMETER.

D. Maskelyne's

Fig. 1.

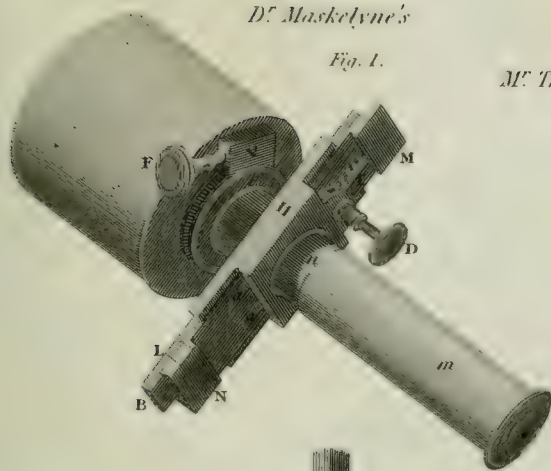

M. Troughton's

Fig. 2.

Fig. 3.

Fig. 4.

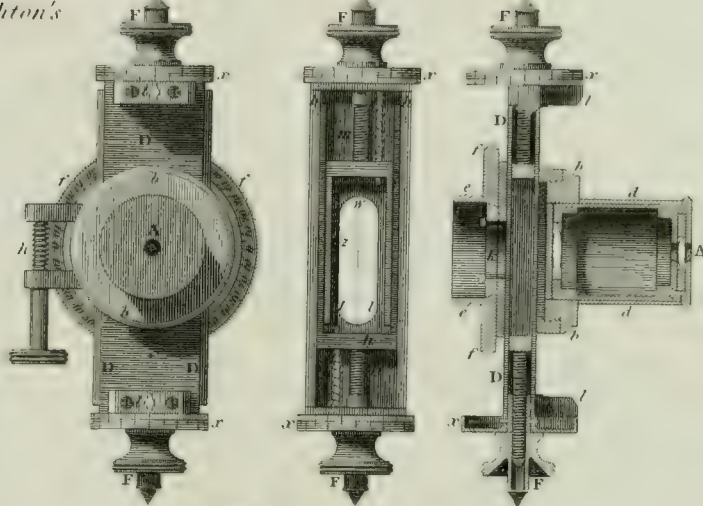

D. Herschel's Lamp Micrometer.

Fig. 5.

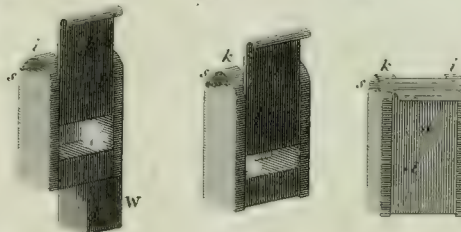
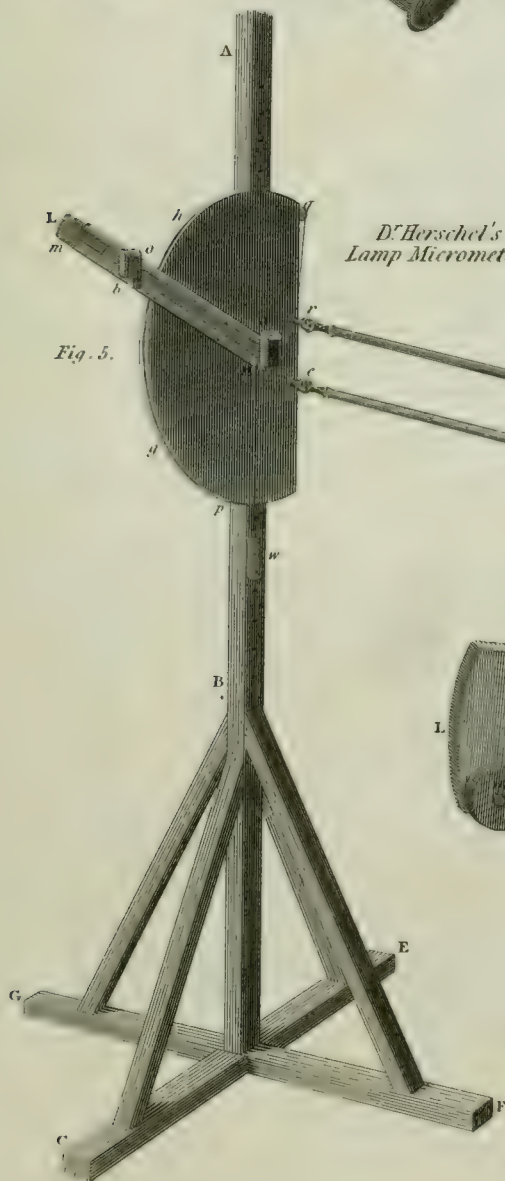

Fig. 6.

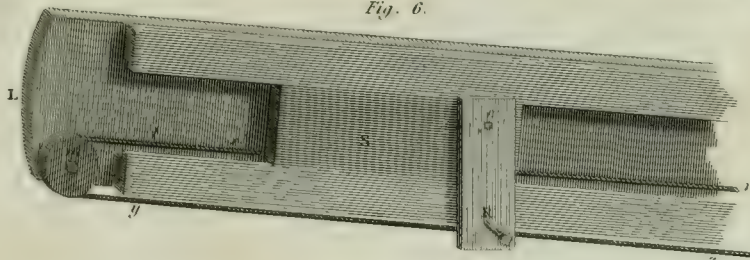
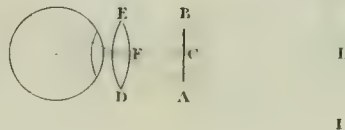

Fig. 10.



OPTICS.
MICROSCOPE Single.

Fig. 1.

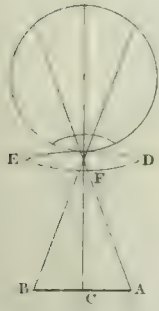

Fig. 3.

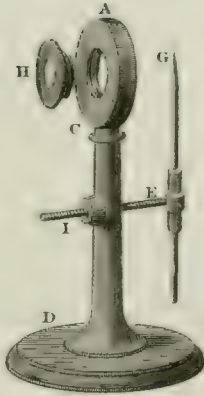

Fig. 2.



Fig. 4.

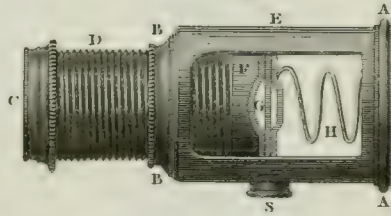
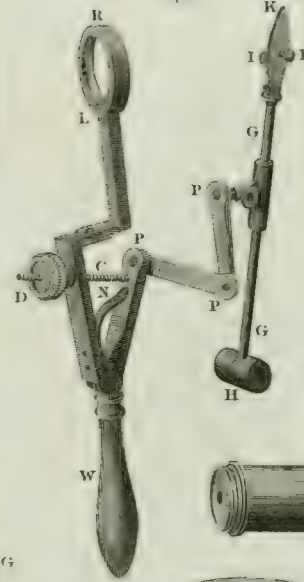

Fig. 5.



K H I

Fig. 6.



Fig. 12.

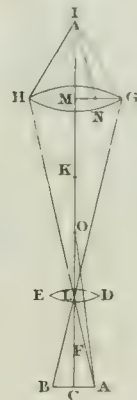

Fig. 10.



Fig. 7.



Fig. 9.

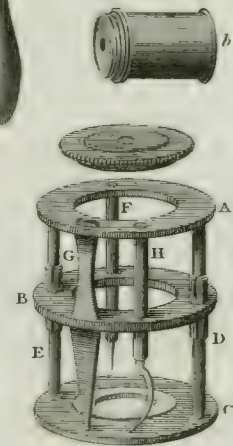

Fig. 8.

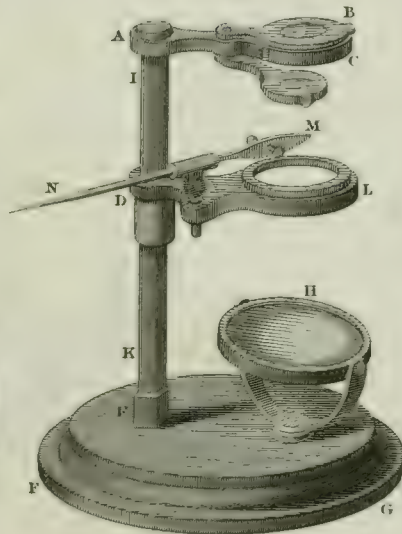
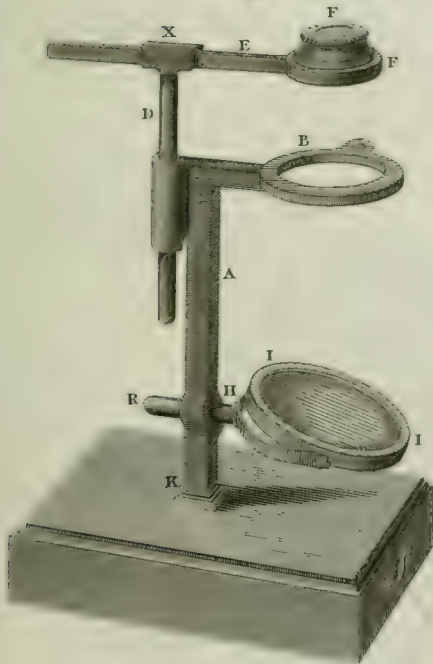
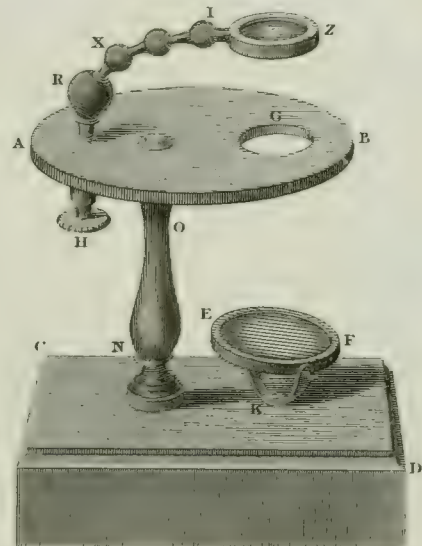

Fig. 11.





OPTICS.
MICROSCOPES.

Marshall's.
Fig. 1.

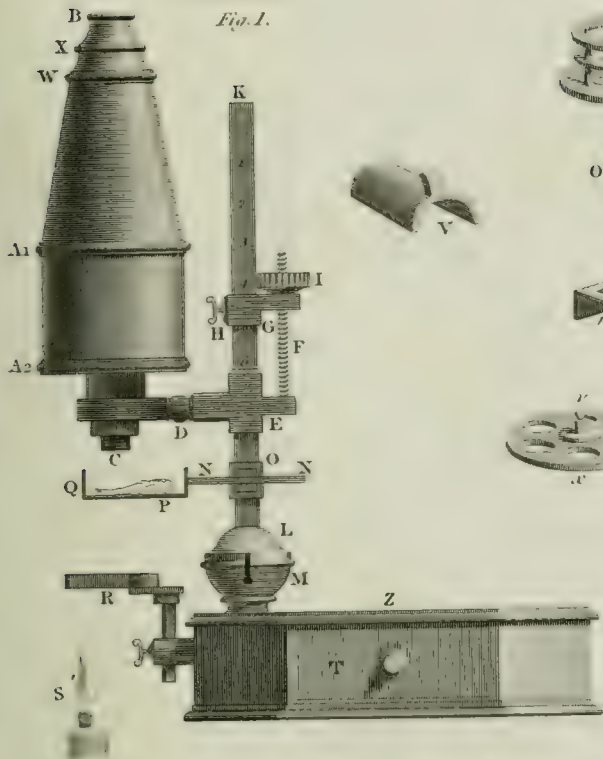
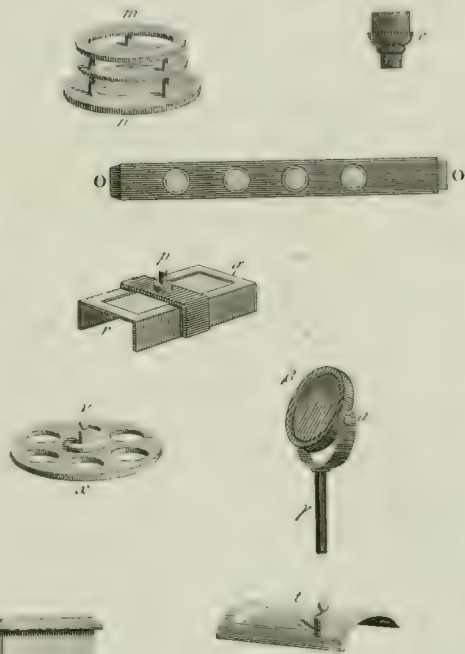

Fig. 2



Gullpepper's.

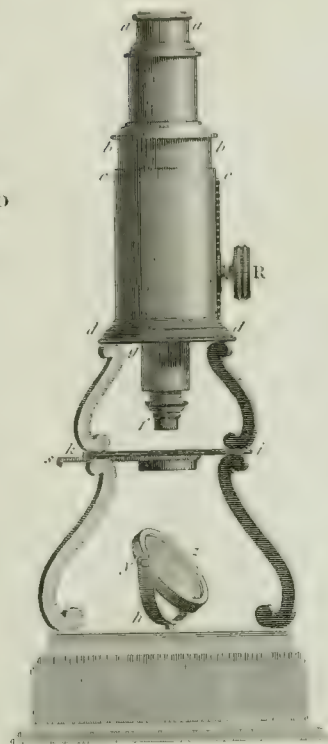

Fig. 4

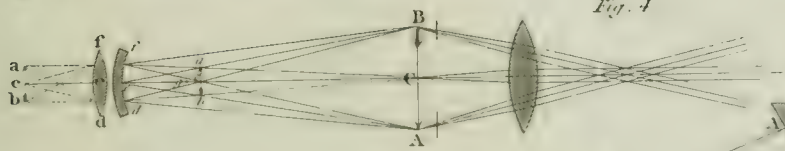

Fig. 3.

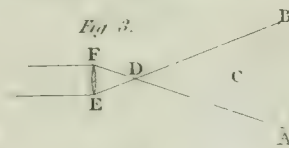
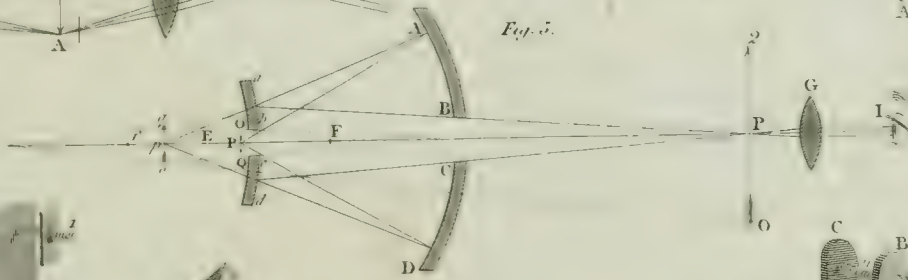

Fig. 5.



Solar Microscope.
Fig. 6.

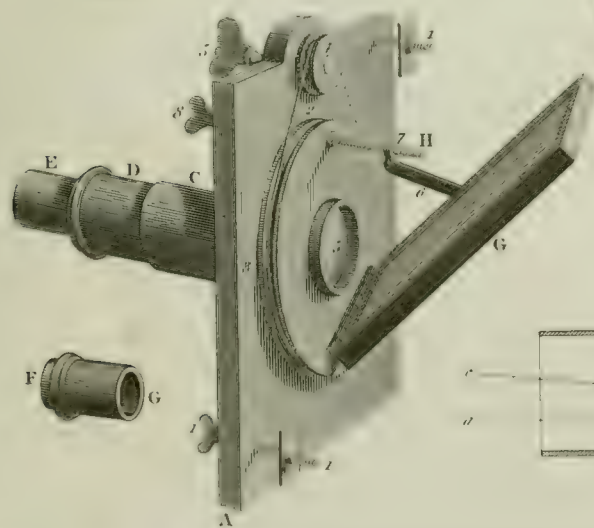

Fig. 8.

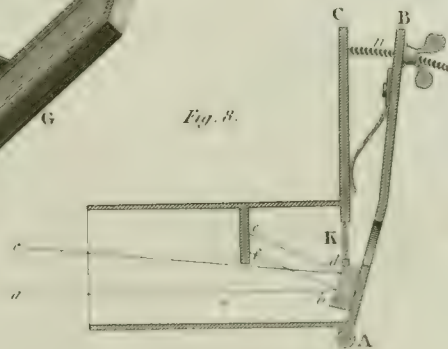
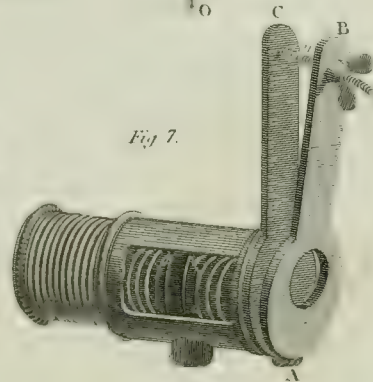
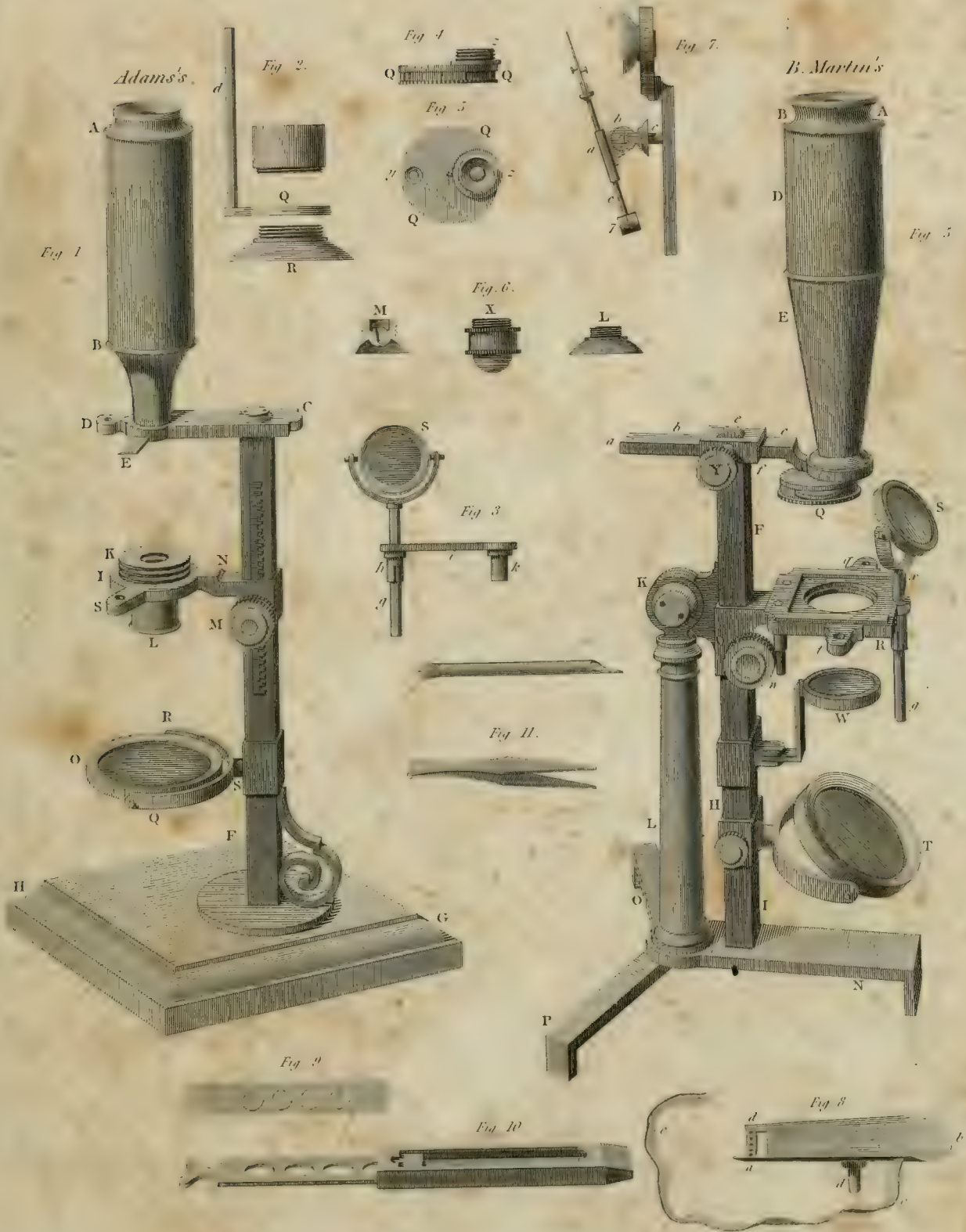

Fig. 7.



OPTICS.

Compound MICROSCOPE.





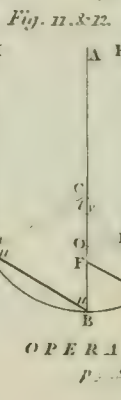
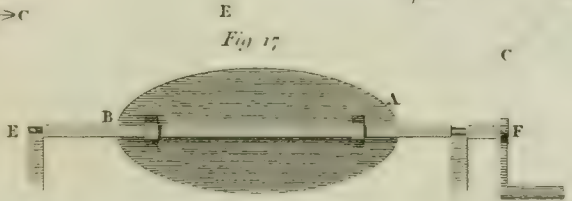
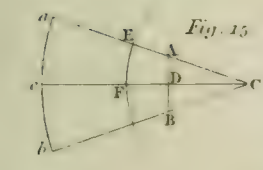
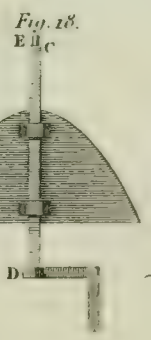
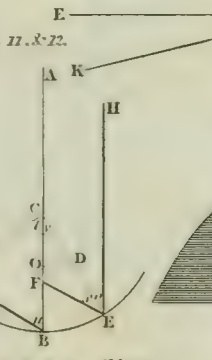
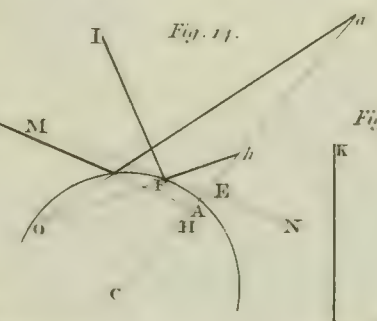
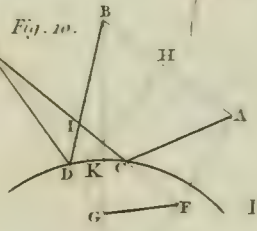
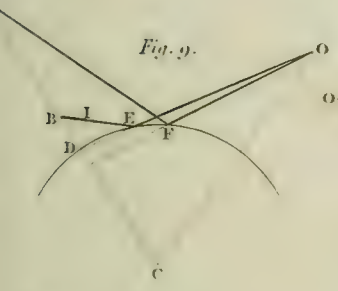
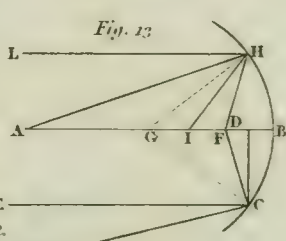
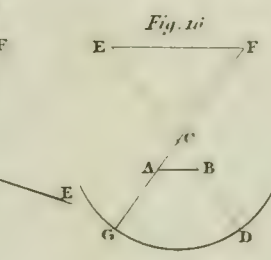
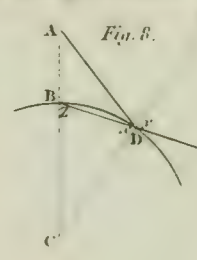
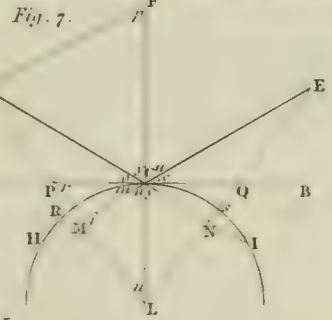
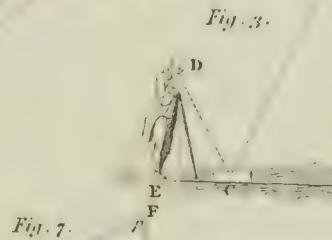
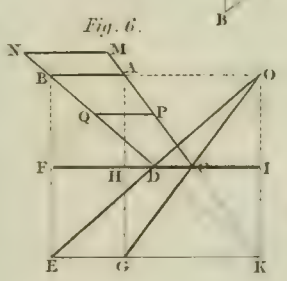
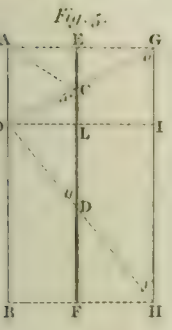
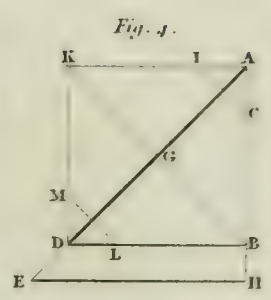
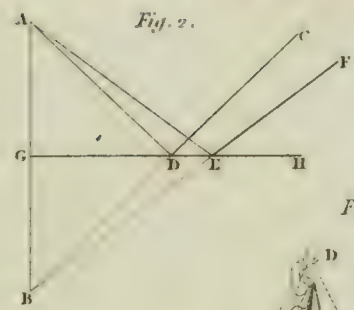
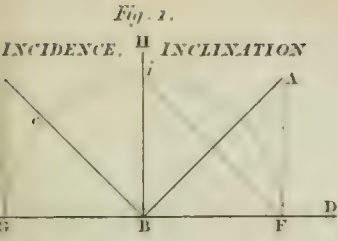

USCÆ Volitantes.

Centering OBJECT Glass.

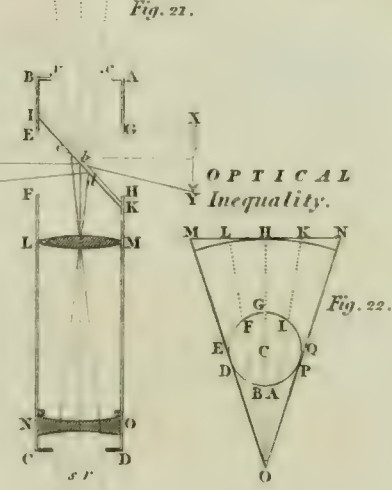
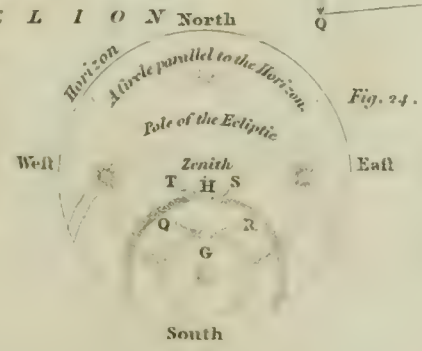
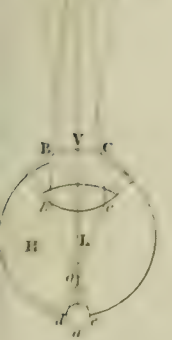
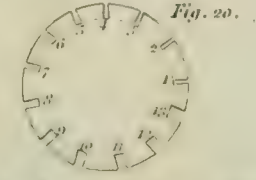
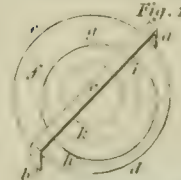
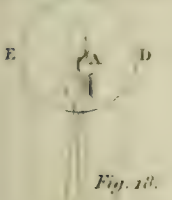

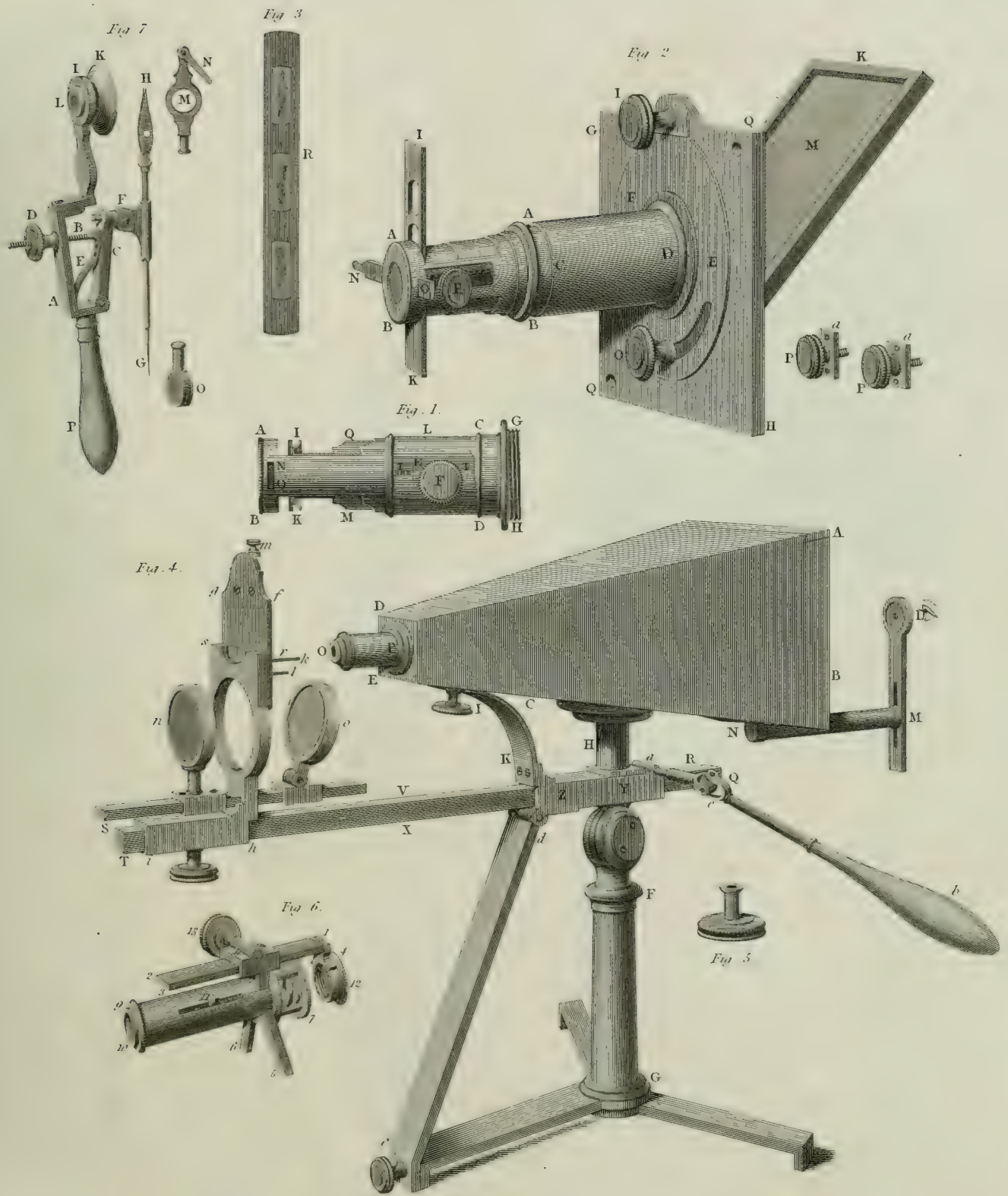

Fig. 5.

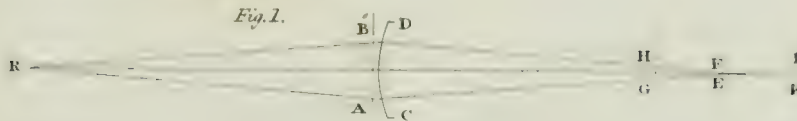

Fig. 2.

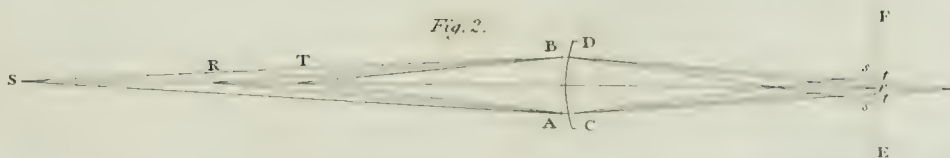

Fig. 3.

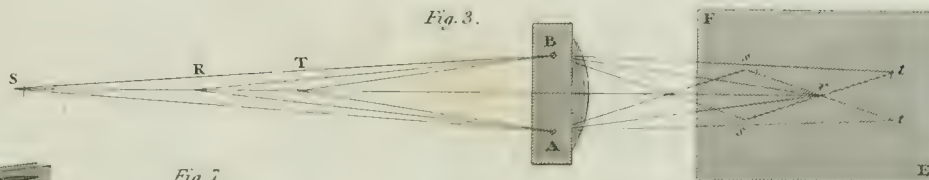

Fig. 7.

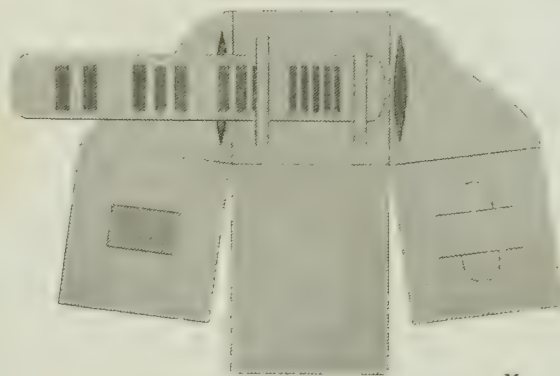
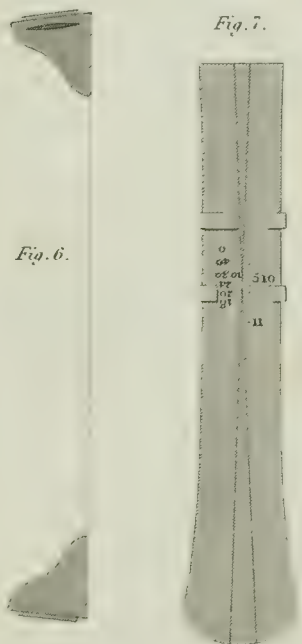

Fig. 4.

Fig. 11.

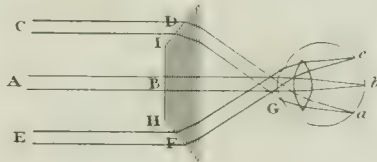

Fig. 12.

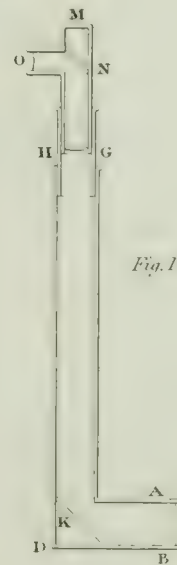

Fig. 9.

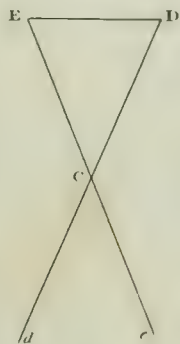

Fig. 13.

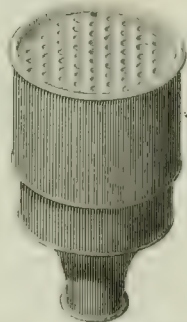

Fig. 12.

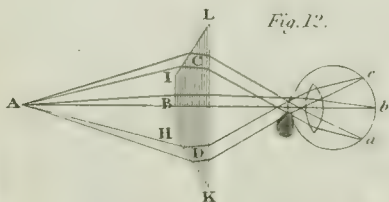

Fig. 10.

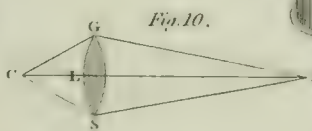

Fig. 15.

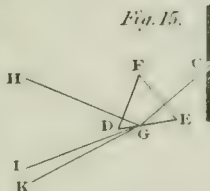
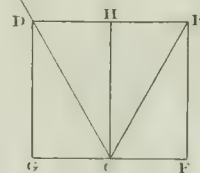

Fig. 14.



FOCUS OF CONVEX, NEAREST X	6	7
SCALE OF INCHES	7	8
FOCUS OF CONVEX, NEAREST X	9	10
SCALE OF INCHES	11	12
FOCUS OF CONVEX, NEAREST X	13	14
SCALE OF INCHES	15	16
FOCUS OF CONVEX, NEAREST X	17	18
SCALE OF INCHES	19	20
FOCUS OF CONVEX, NEAREST X	21	22
SCALE OF INCHES	23	24
FOCUS OF CONVEX, NEAREST X	25	26
SCALE OF INCHES	27	28
FOCUS OF CONVEX, NEAREST X	29	30
SCALE OF INCHES	31	32
FOCUS OF CONVEX, NEAREST X	33	34
SCALE OF INCHES	35	36
FOCUS OF CONVEX, NEAREST X	37	38
SCALE OF INCHES	39	40
FOCUS OF CONVEX, NEAREST X	41	42
SCALE OF INCHES	43	44
FOCUS OF CONVEX, NEAREST X	45	46
SCALE OF INCHES	47	48
FOCUS OF CONVEX, NEAREST X	49	50
SCALE OF INCHES	51	52
FOCUS OF CONVEX, NEAREST X	53	54
SCALE OF INCHES	55	56
FOCUS OF CONVEX, NEAREST X	57	58
SCALE OF INCHES	59	60
FOCUS OF CONVEX, NEAREST X	61	62
SCALE OF INCHES	63	64
FOCUS OF CONVEX, NEAREST X	65	66
SCALE OF INCHES	67	68
FOCUS OF CONVEX, NEAREST X	69	70
SCALE OF INCHES	71	72
FOCUS OF CONVEX, NEAREST X	73	74
SCALE OF INCHES	75	76
FOCUS OF CONVEX, NEAREST X	77	78
SCALE OF INCHES	79	80
FOCUS OF CONVEX, NEAREST X	81	82
SCALE OF INCHES	83	84
FOCUS OF CONVEX, NEAREST X	85	86
SCALE OF INCHES	87	88
FOCUS OF CONVEX, NEAREST X	89	90
SCALE OF INCHES	91	92
FOCUS OF CONVEX, NEAREST X	93	94
SCALE OF INCHES	95	96
FOCUS OF CONVEX, NEAREST X	97	98
SCALE OF INCHES	99	100

Fig. 1.

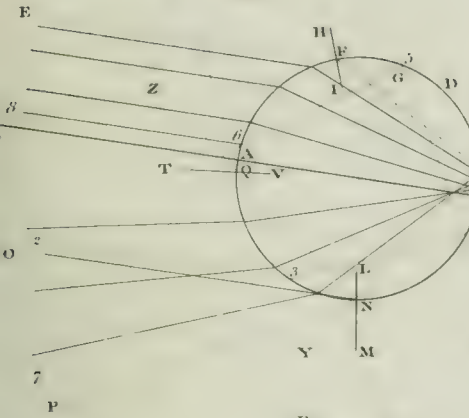

Fig. 2.

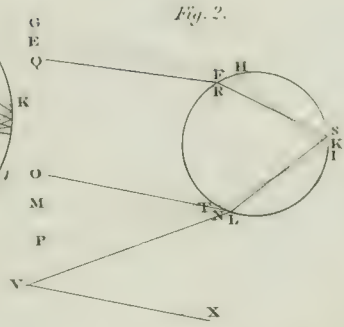

Fig. 4.

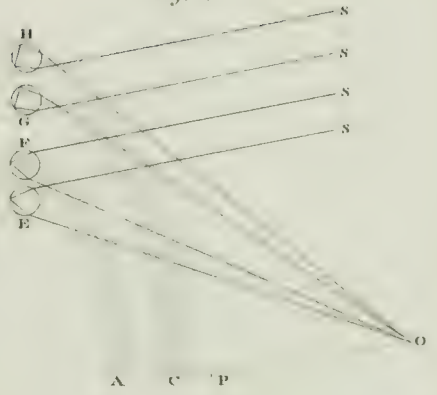

Fig. 6.

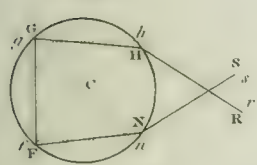

Fig. 7.

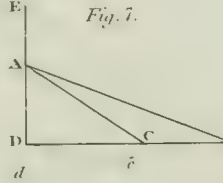

Fig. 3.

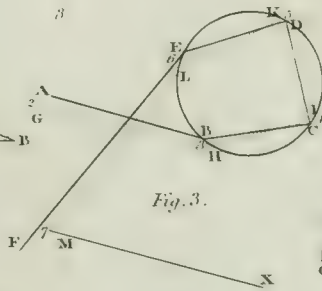

Fig. 8.

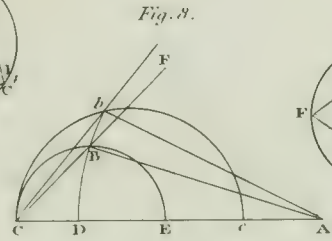

Fig. 5.

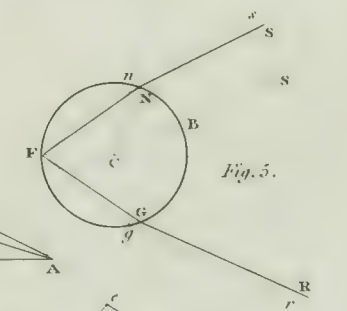

Fig. 11.

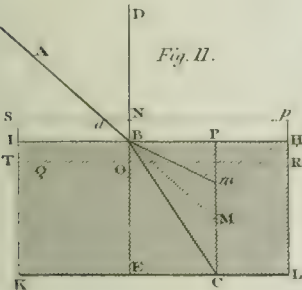

Fig. 10.

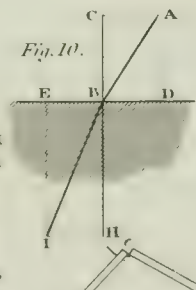

Fig. 9.

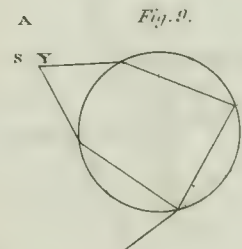

Fig. 12.

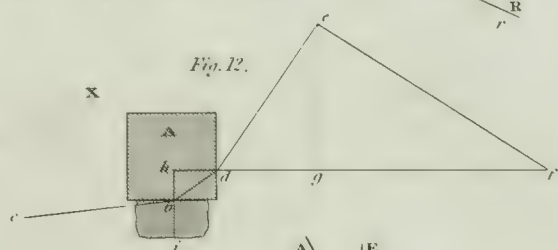

Fig. 13.

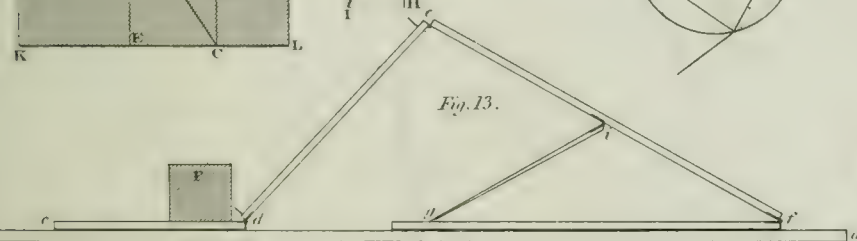

Fig. 14.

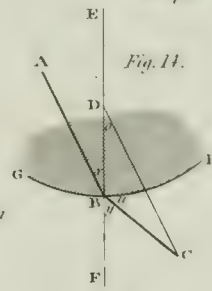

Fig. 15.

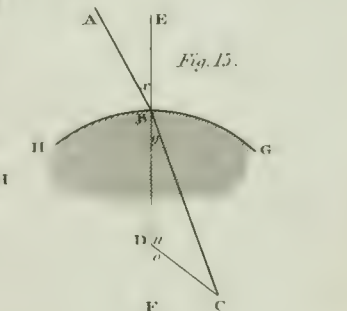

Fig. 16.

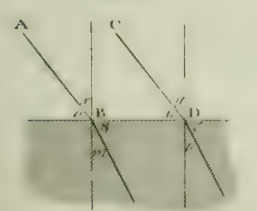

Fig. 17.

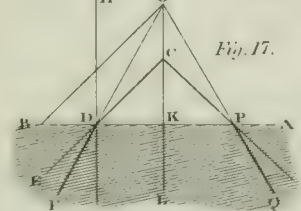

Fig. 18.

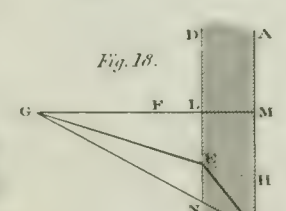

Fig. 19.

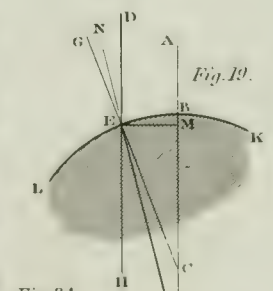

Fig. 20.

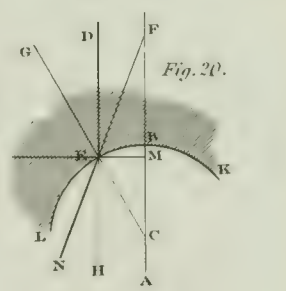

Fig. 22.

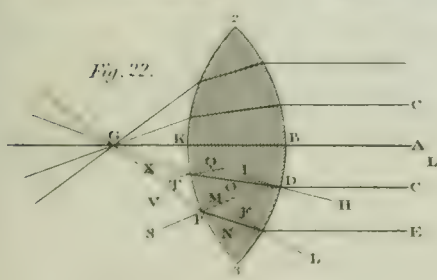

Fig. 23.

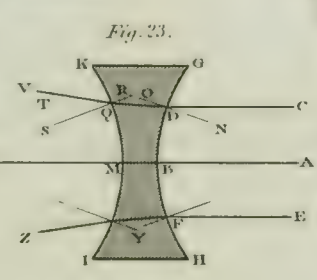

Fig. 24.

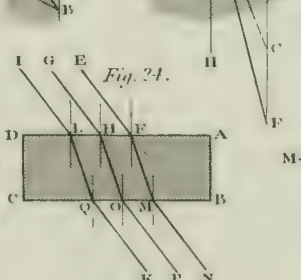

Fig. 21.

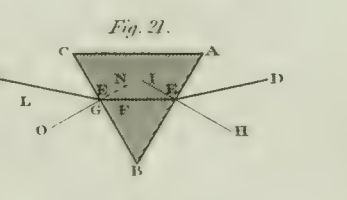

Fig. 1. & 2.

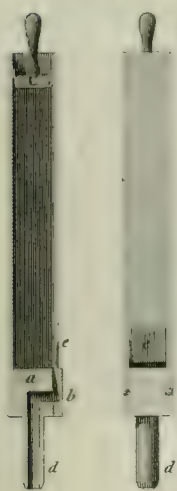

Fig. 3. & 4.

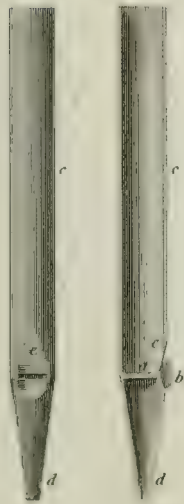

Fig. 5. & 6.

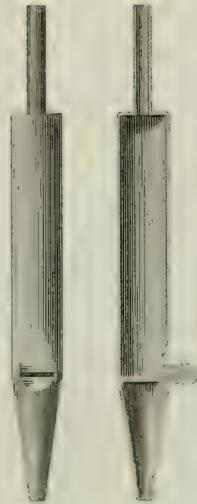

Fig. 7.



Fig. 8. & 9.

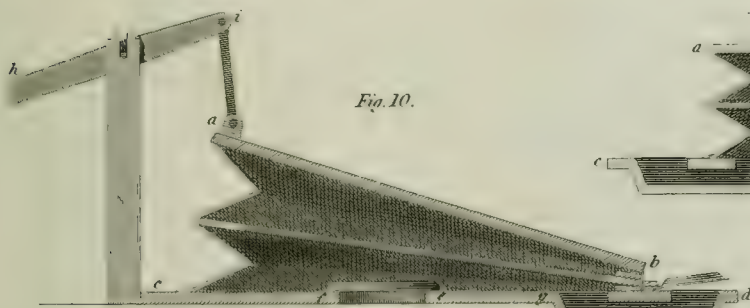
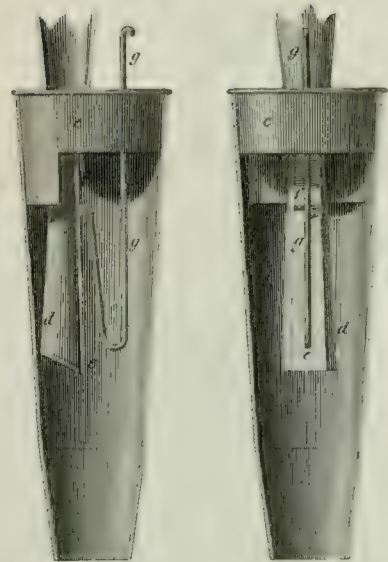

Fig. 10.

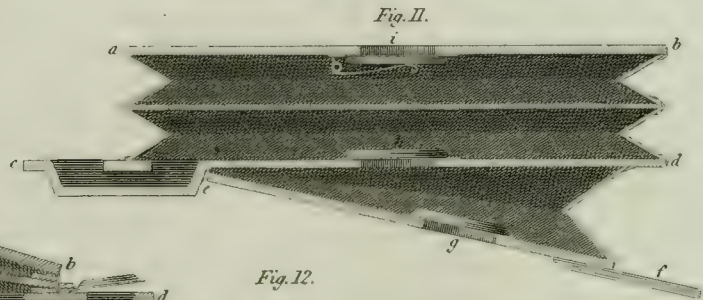

Fig. 11.

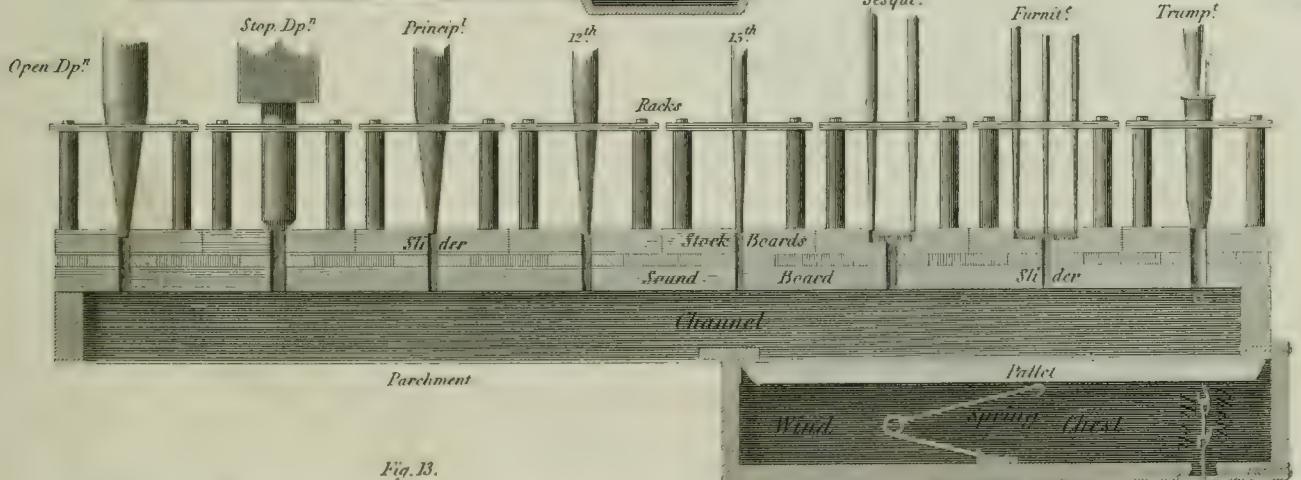
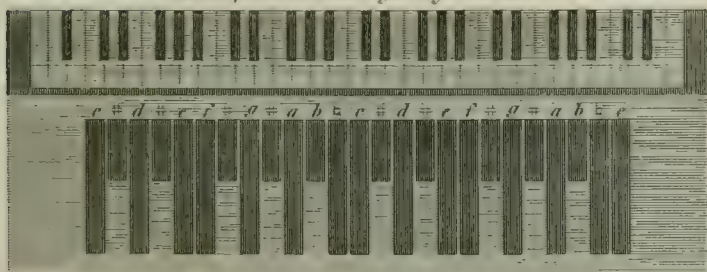

Fig. 12.

Fig. 13.

Relative position of the finger keys & Pedals.



Interior Profile of an English Church ORGAN.

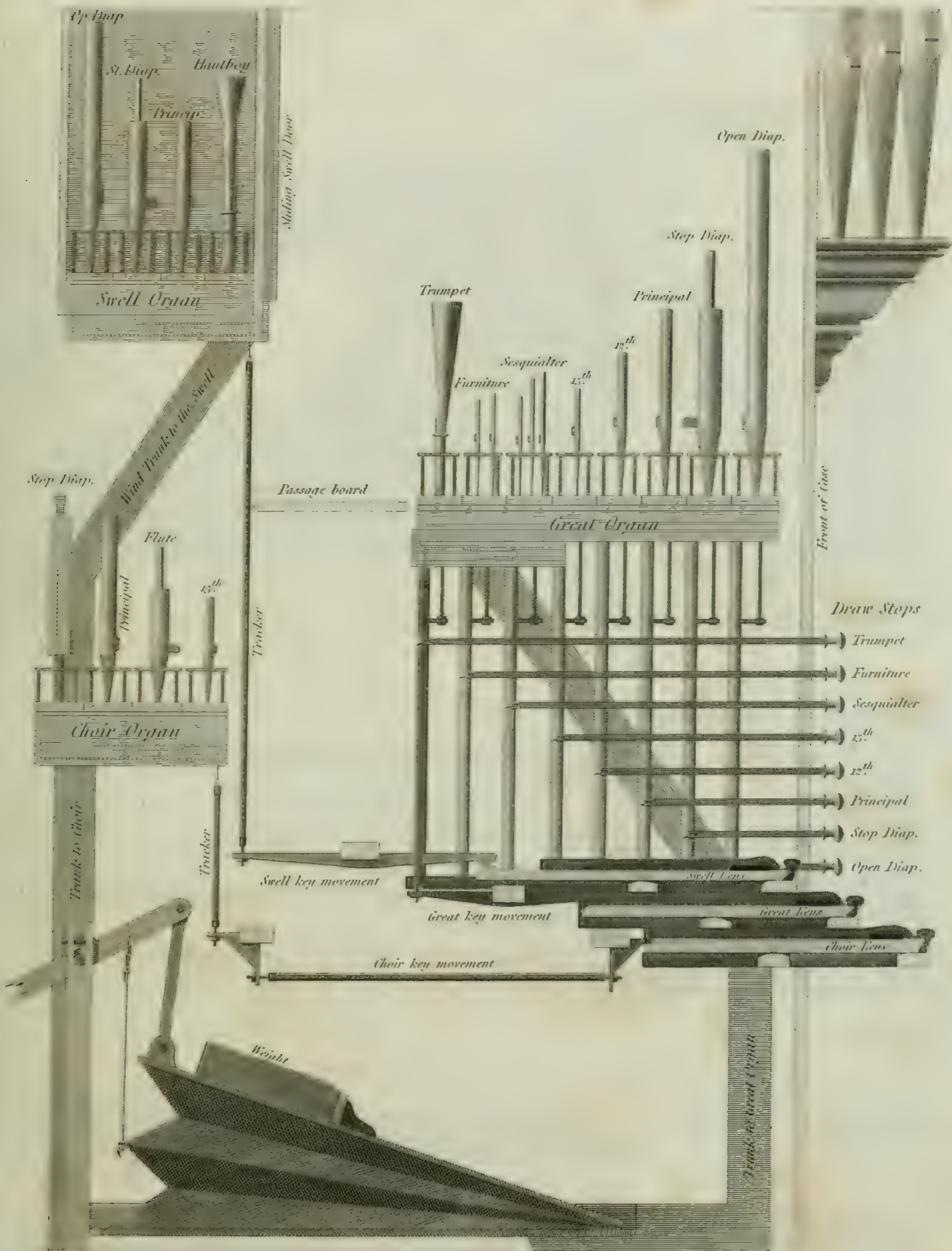

Fig. 4.



Fig. 3.

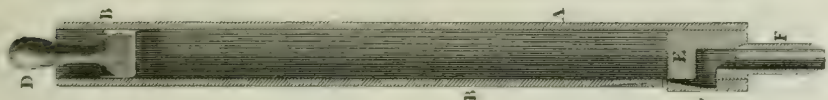

Fig. 1.

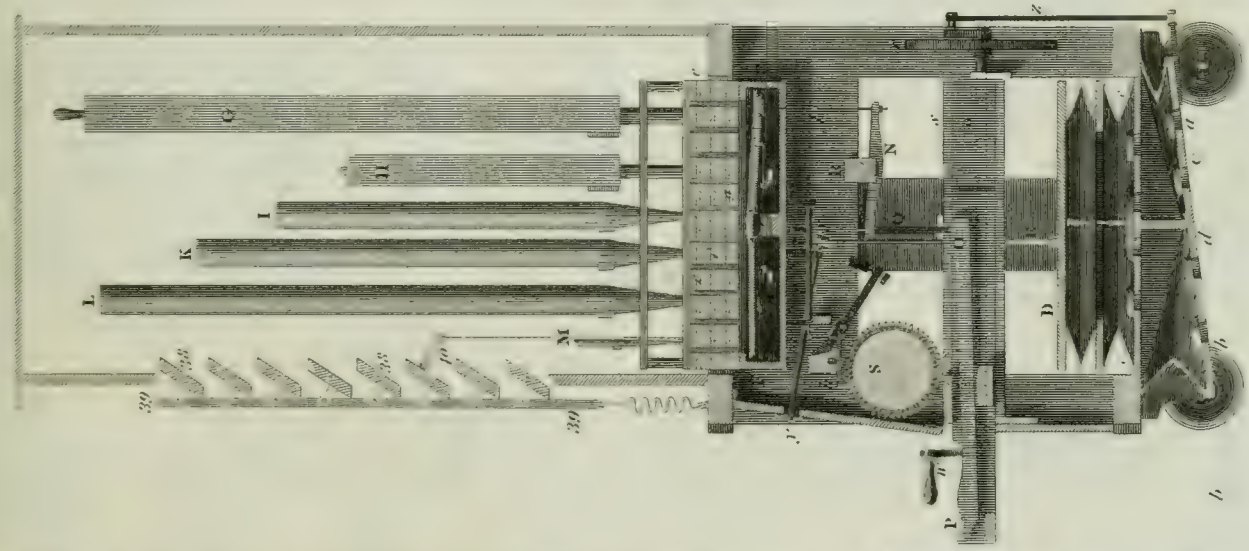

Fig. 2.

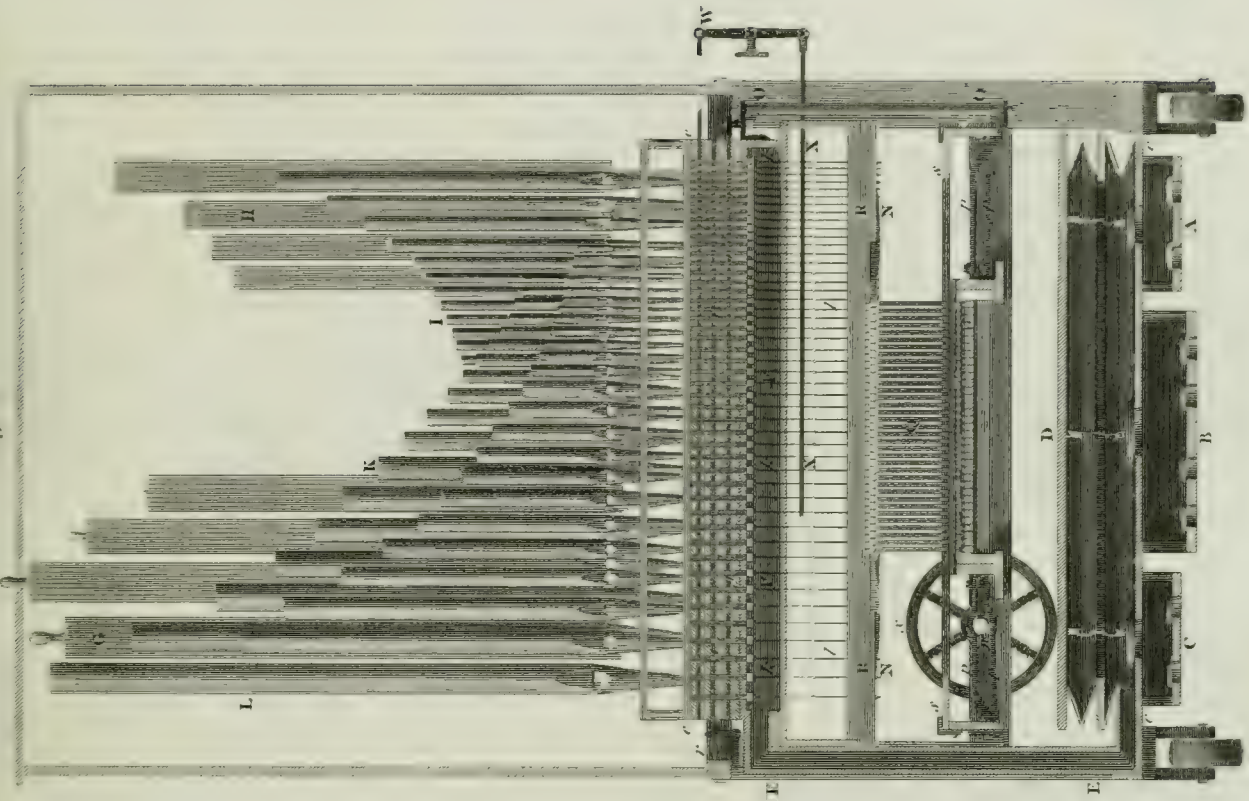
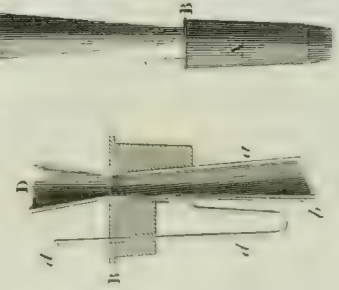
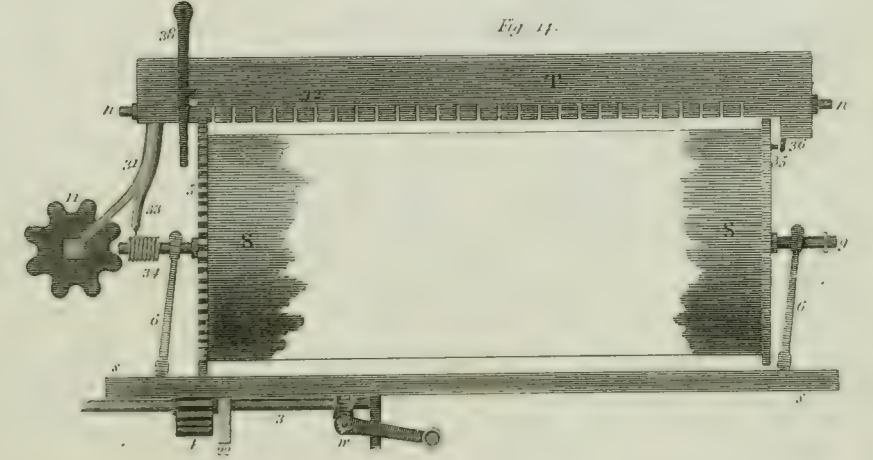
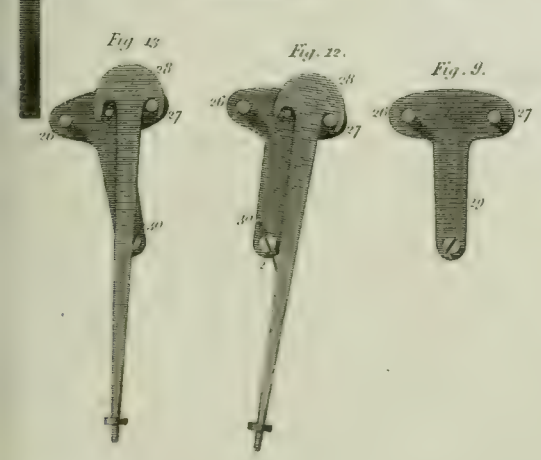
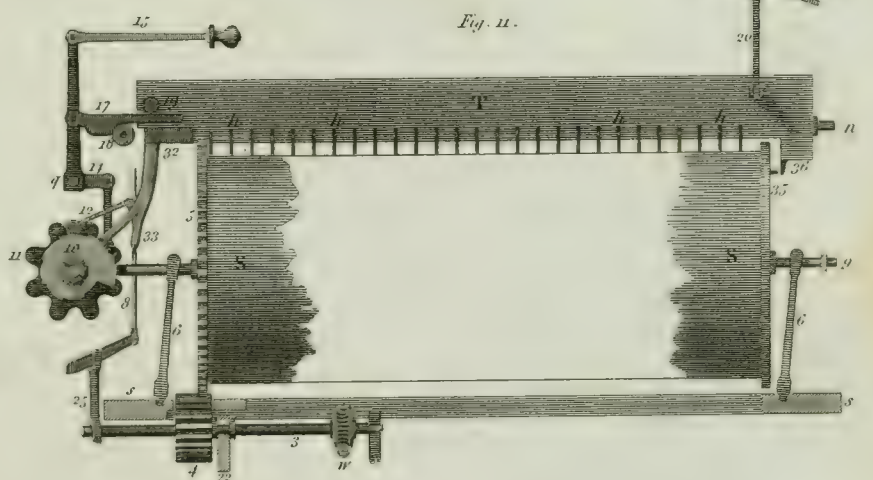
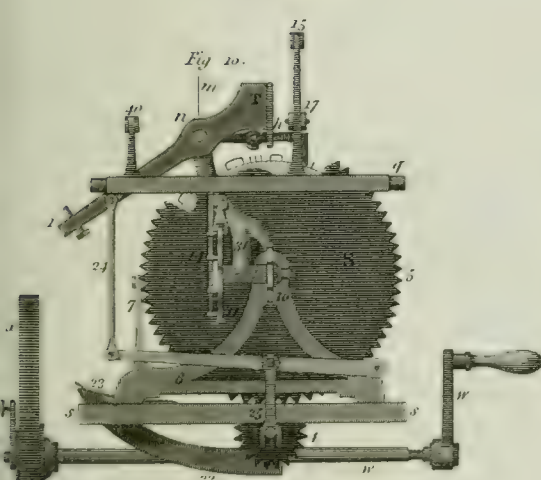
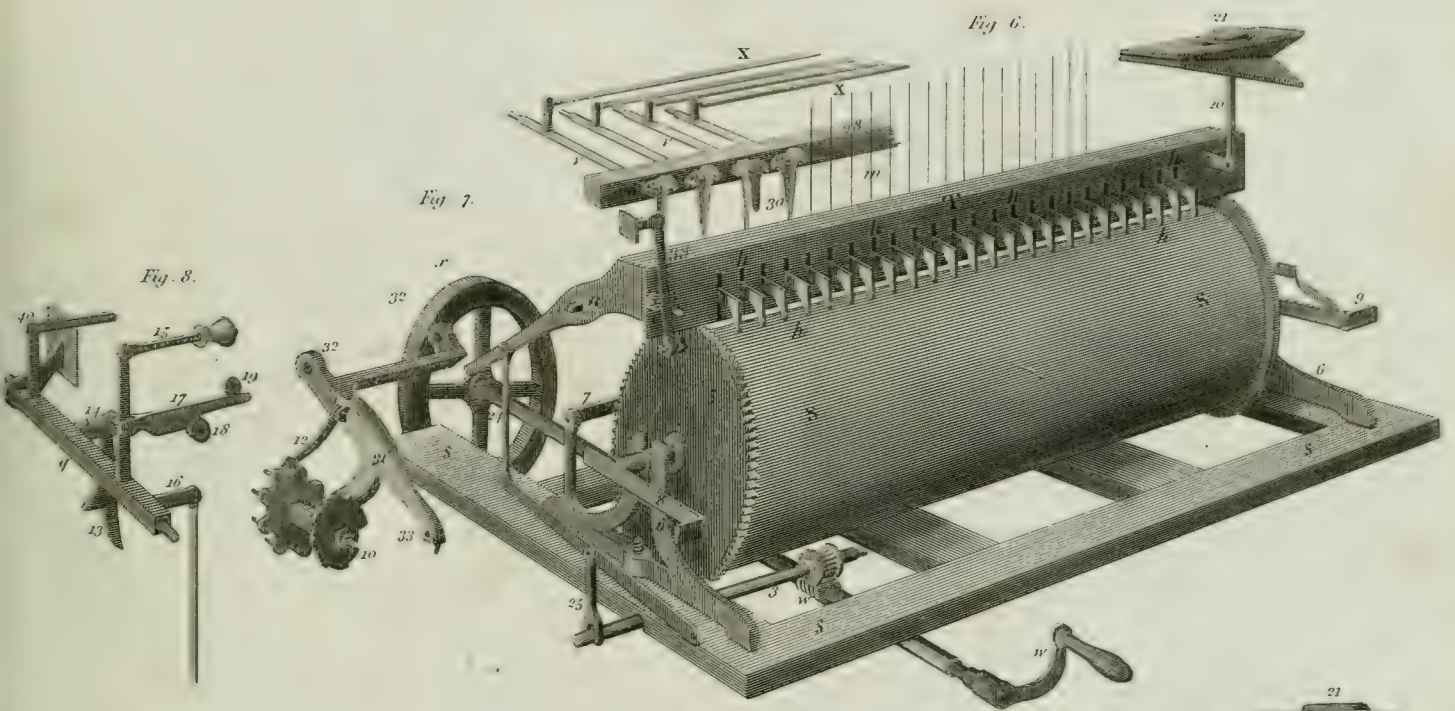

Fig. 5.





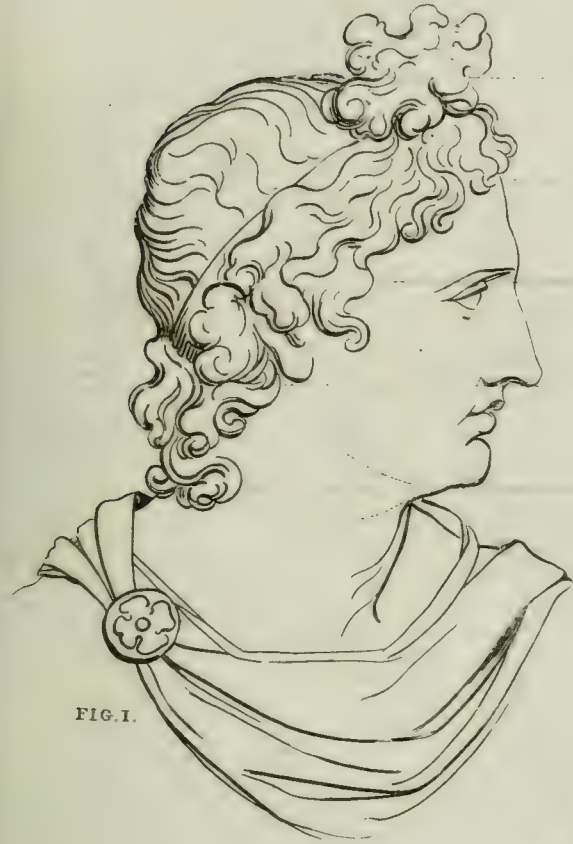

FIG. 1.



FIG 2

Apollo Belvidere



FIG. 3



FIG 4.

Venus de Medicis

PAINTING.

Diversities of the Human Face.





*American
Nootka Sound*



European



*Asiatic
Palestine*



*Asiatic
Chinese*



*African
Hottentot*

Fig. 2. N° 1.

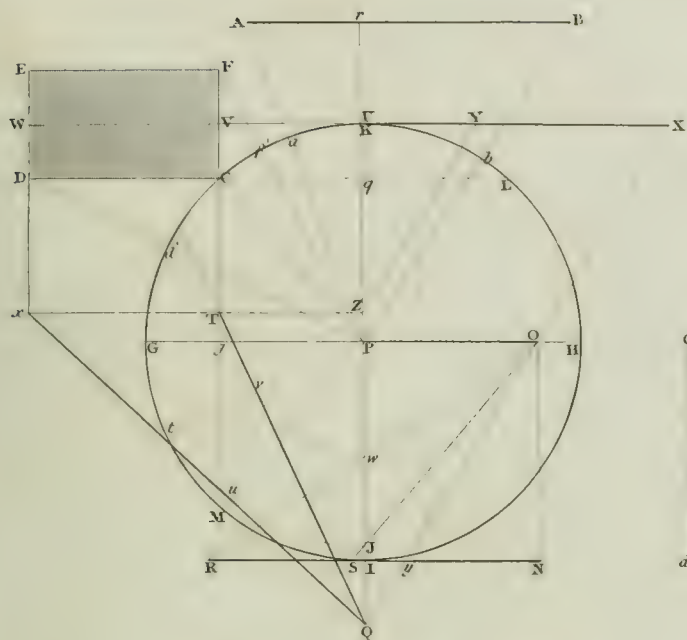

Fig. 2. N° 5.

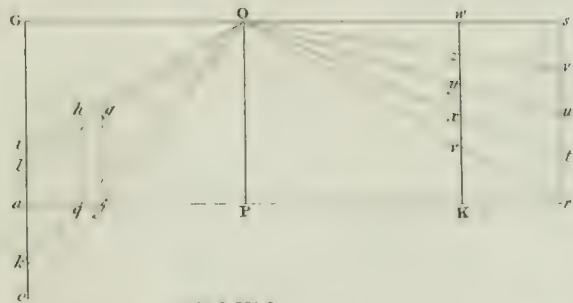

Fig. 2. N° 2.

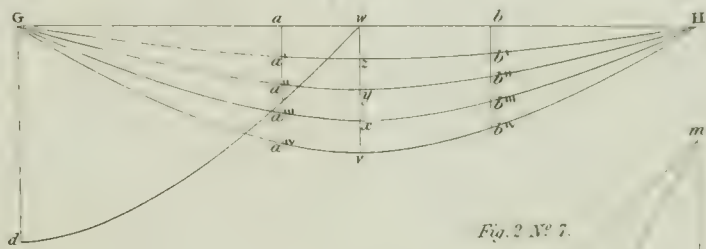

Fig. 2. N° 7.

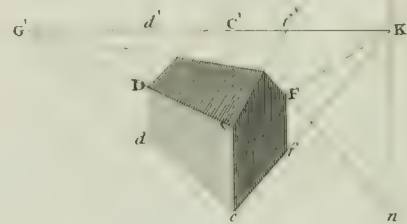

Fig. 1.

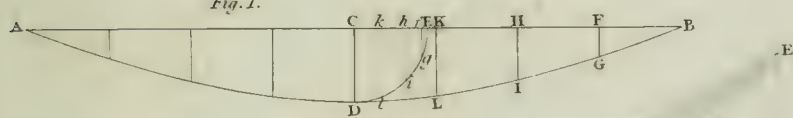

Fig. 3.

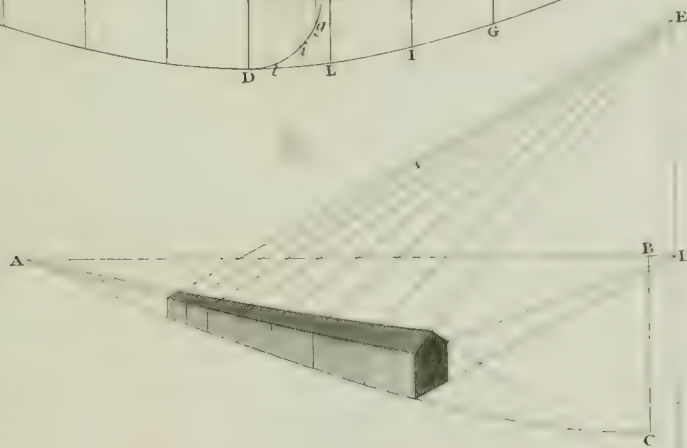

Fig. 2. N° 6.

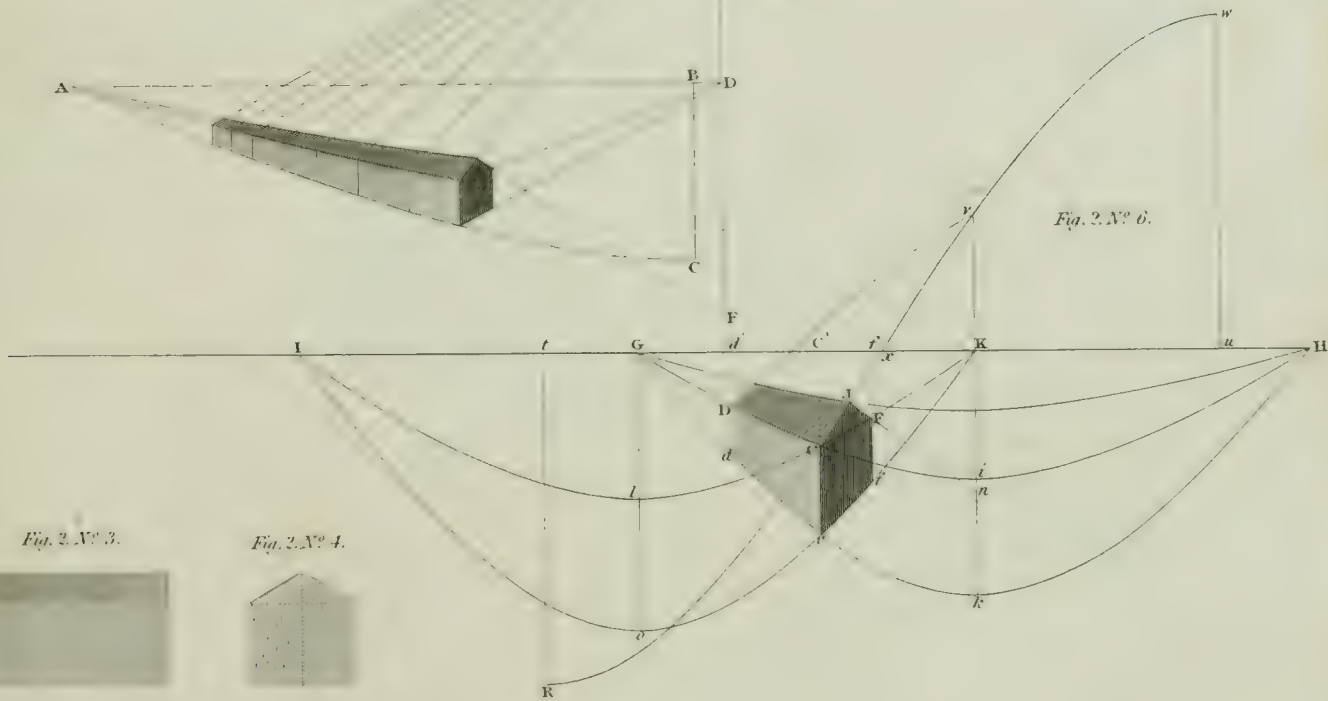
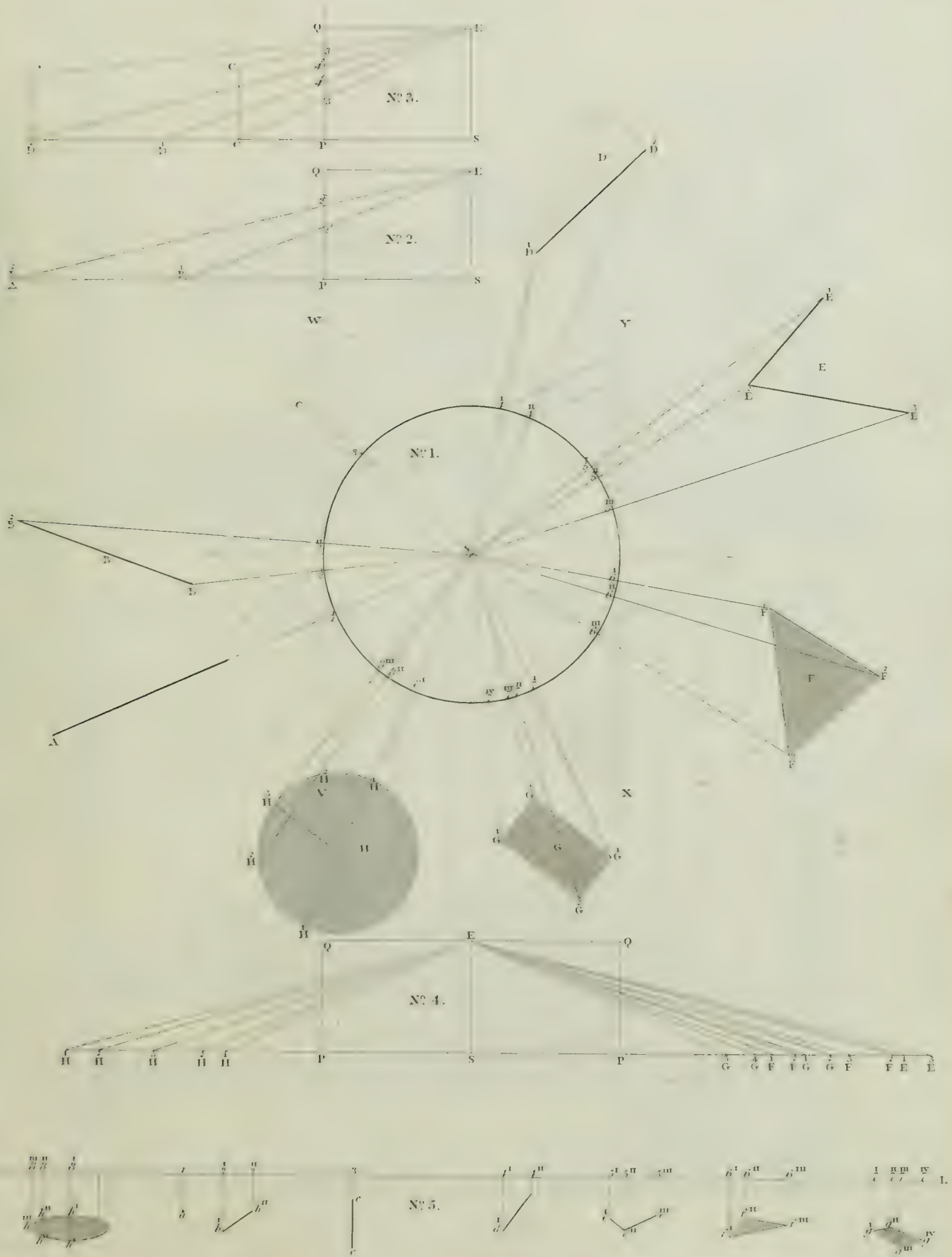

Fig. 2. N° 3.

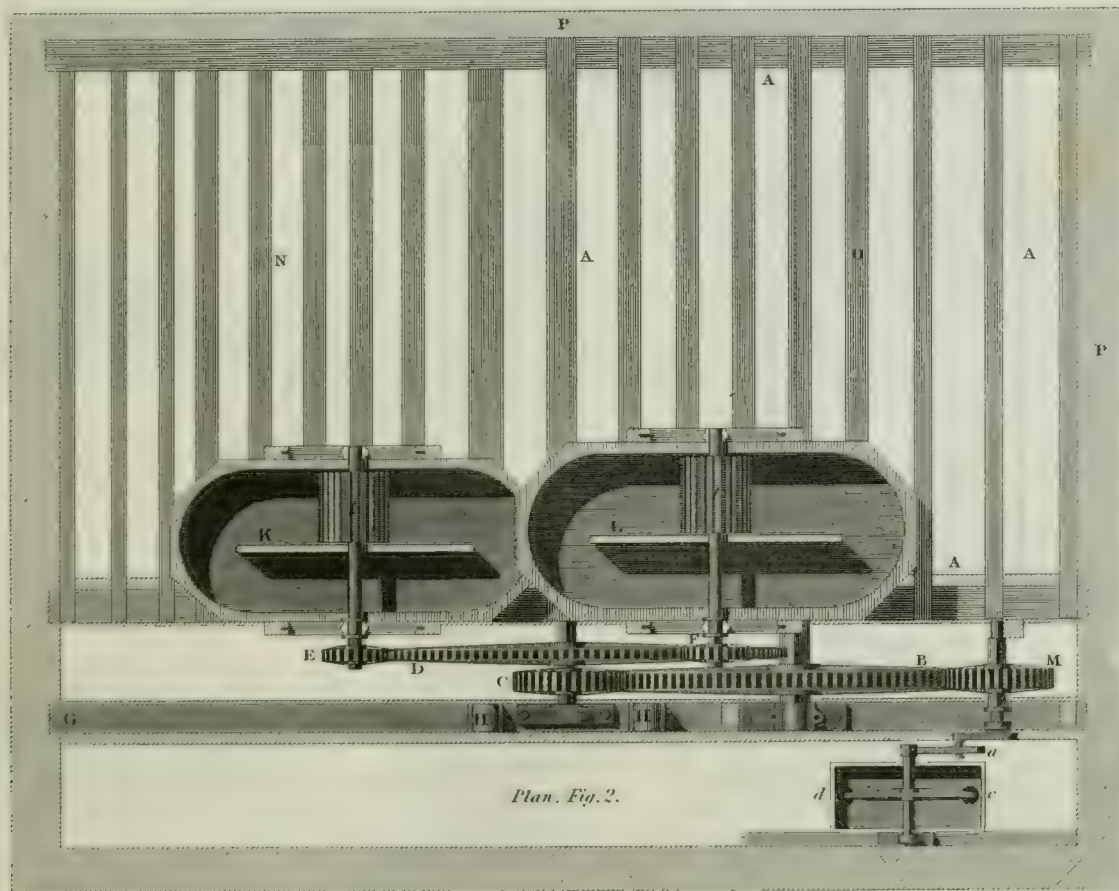
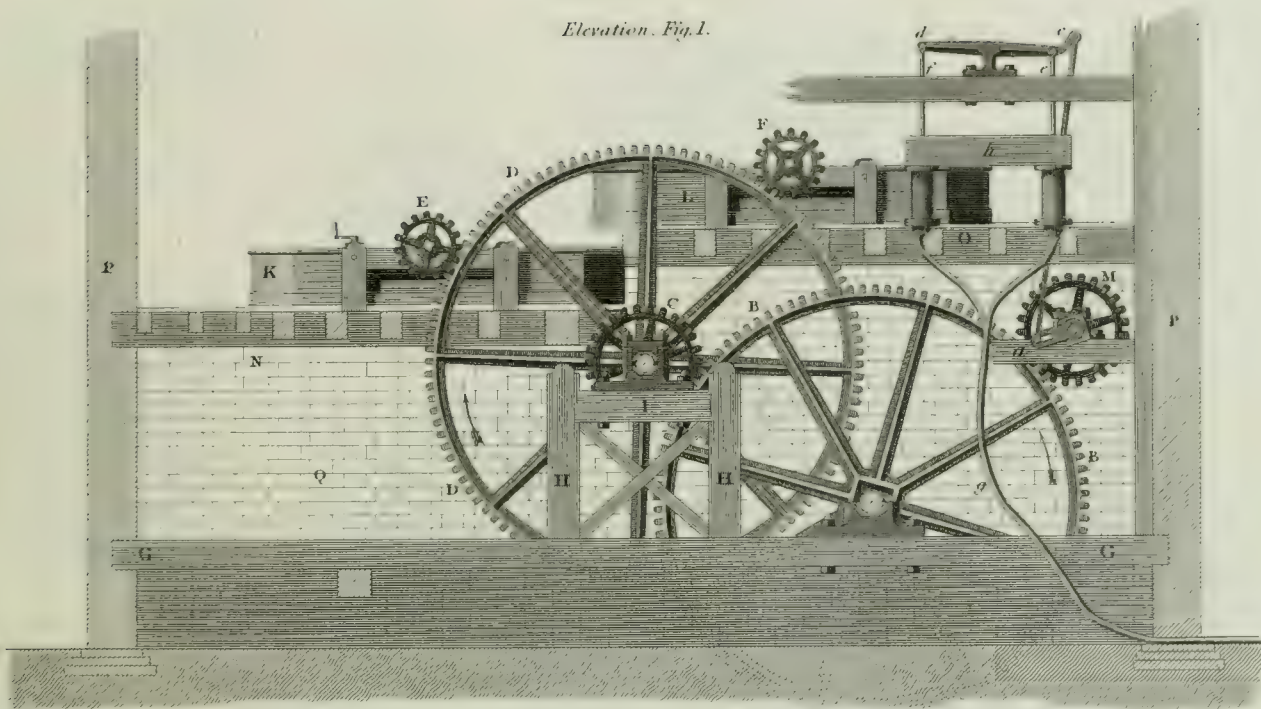

Fig. 2. N° 4.





Elevation. Fig. 1.



Plan. Fig. 2.

Fig. 3.

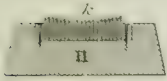

Fig. 4.

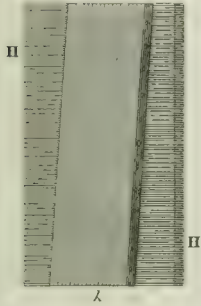

Fig. 1. Section of an Engine.

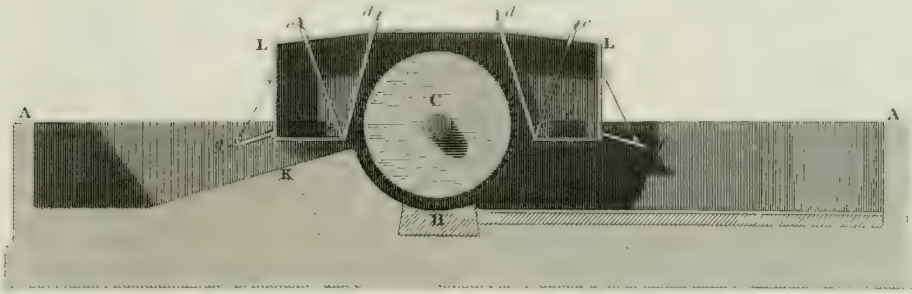

Fig. 2.

Plan

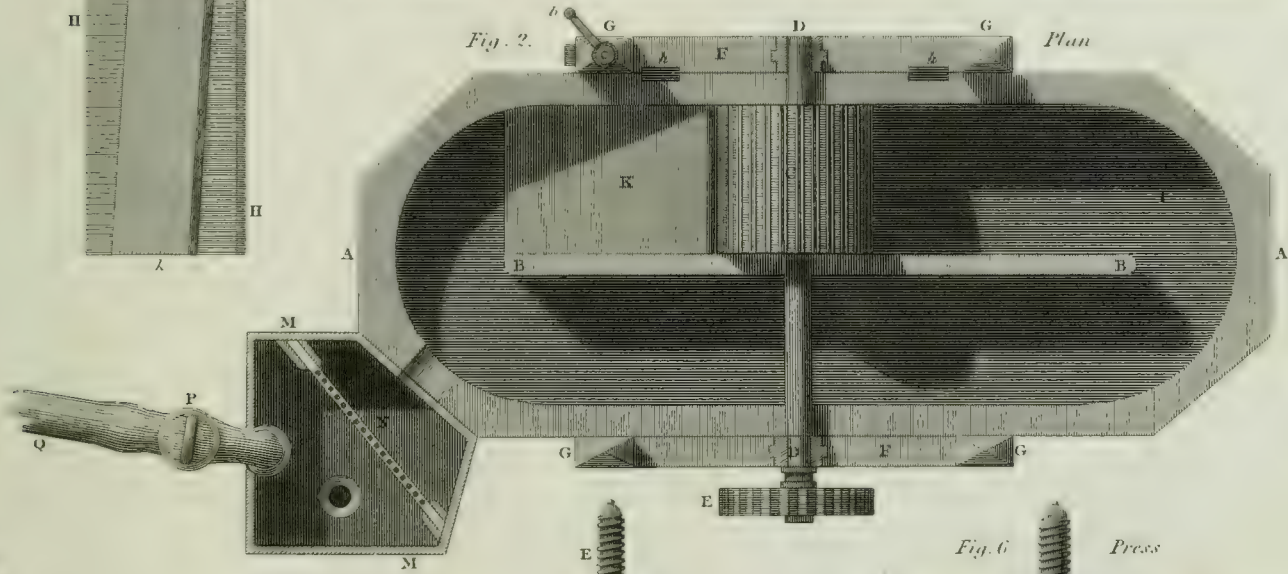

Fig. 3.

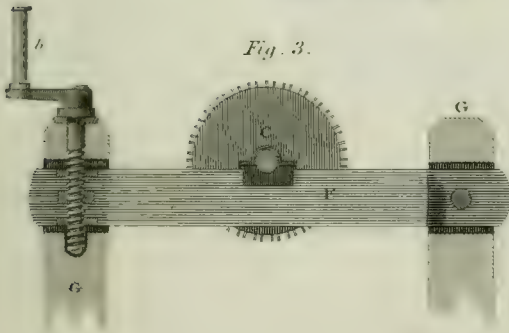

Fig. 7.

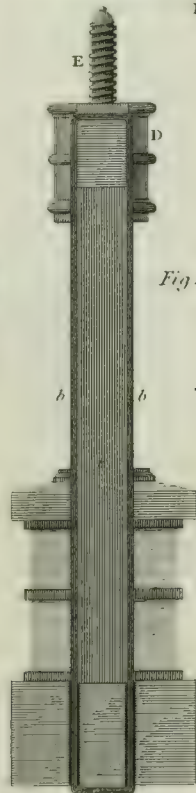
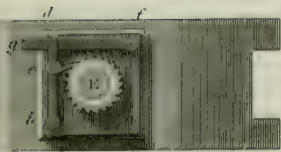
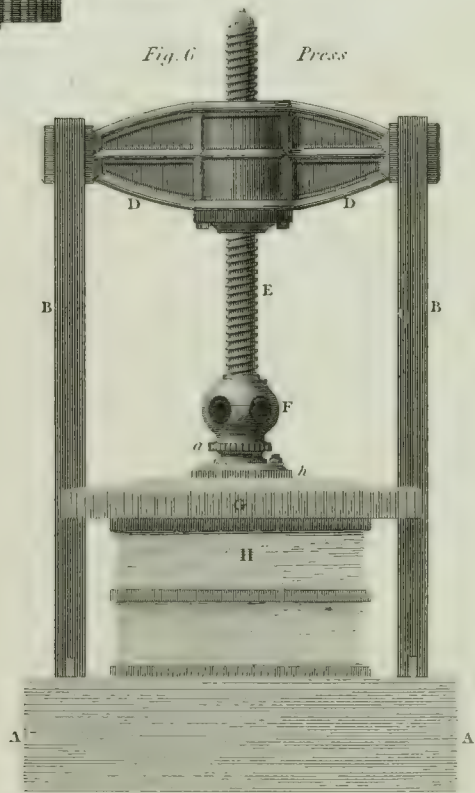
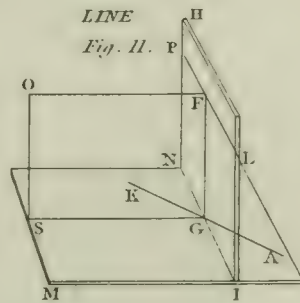
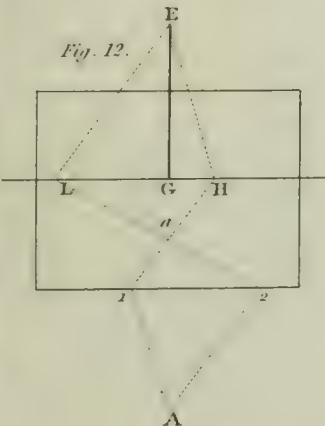
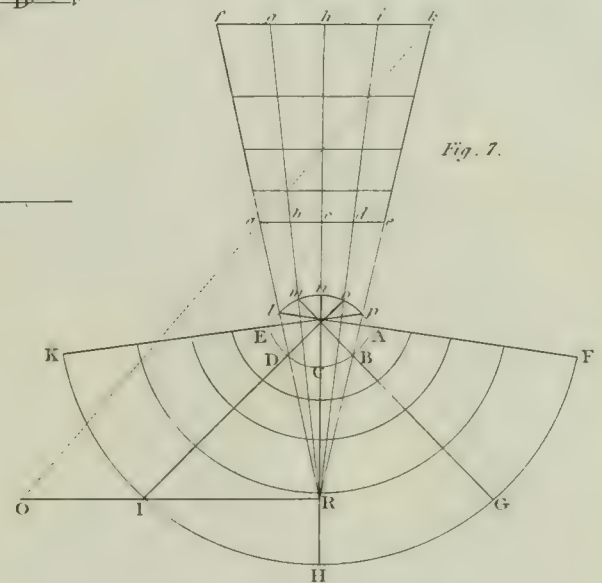
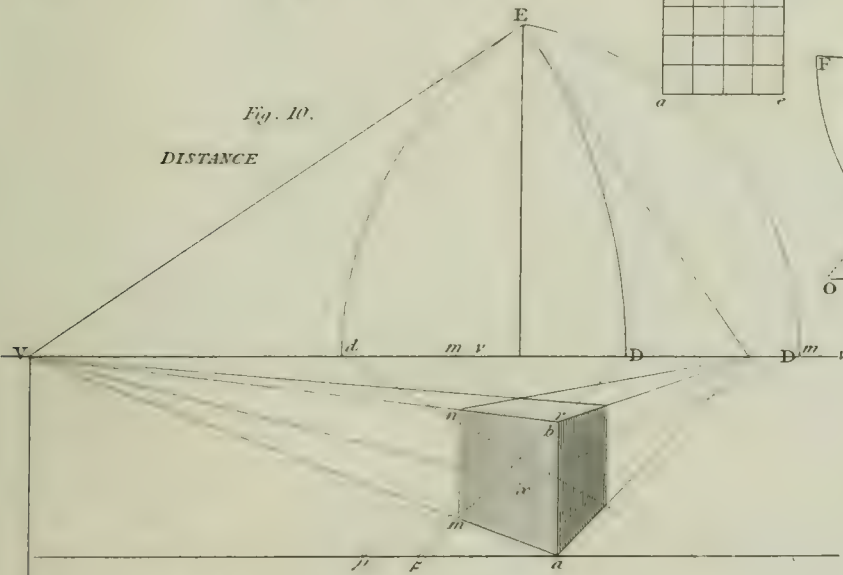
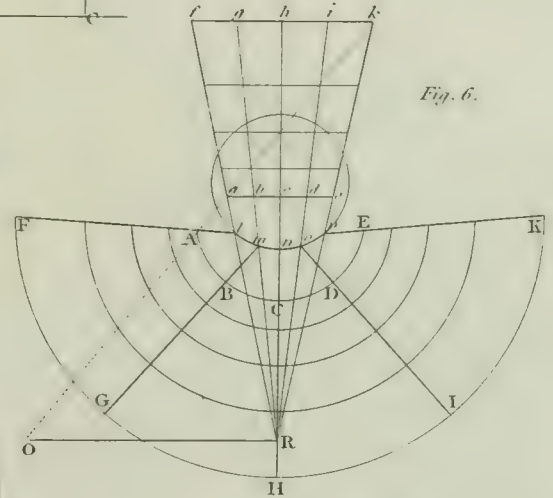
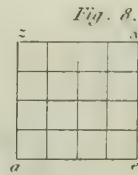
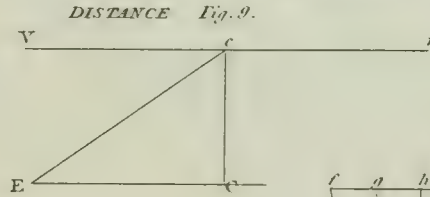
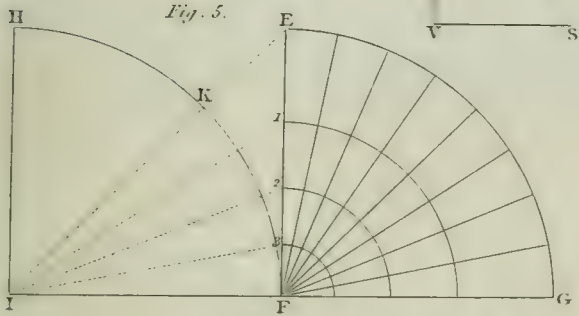
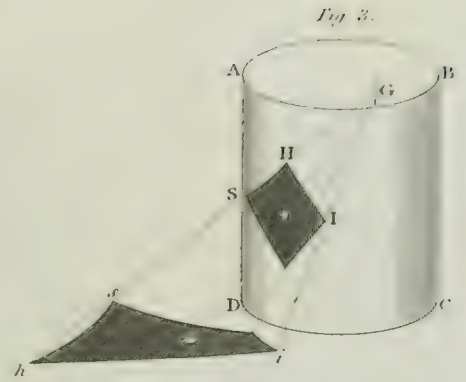
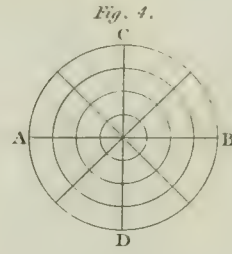
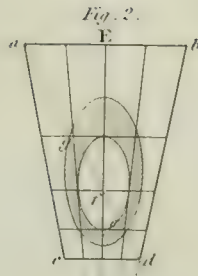
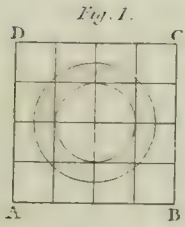

Fig. 6. Press



PERSPECTIVE .

ANAMORPHOSIS.



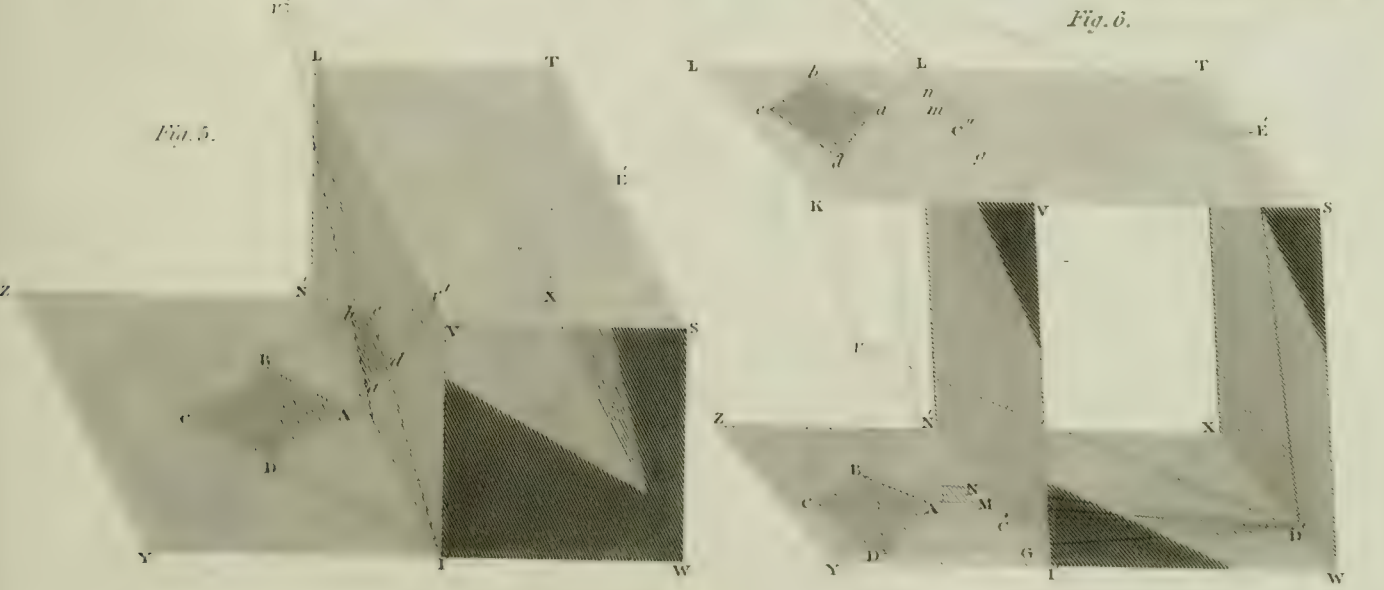
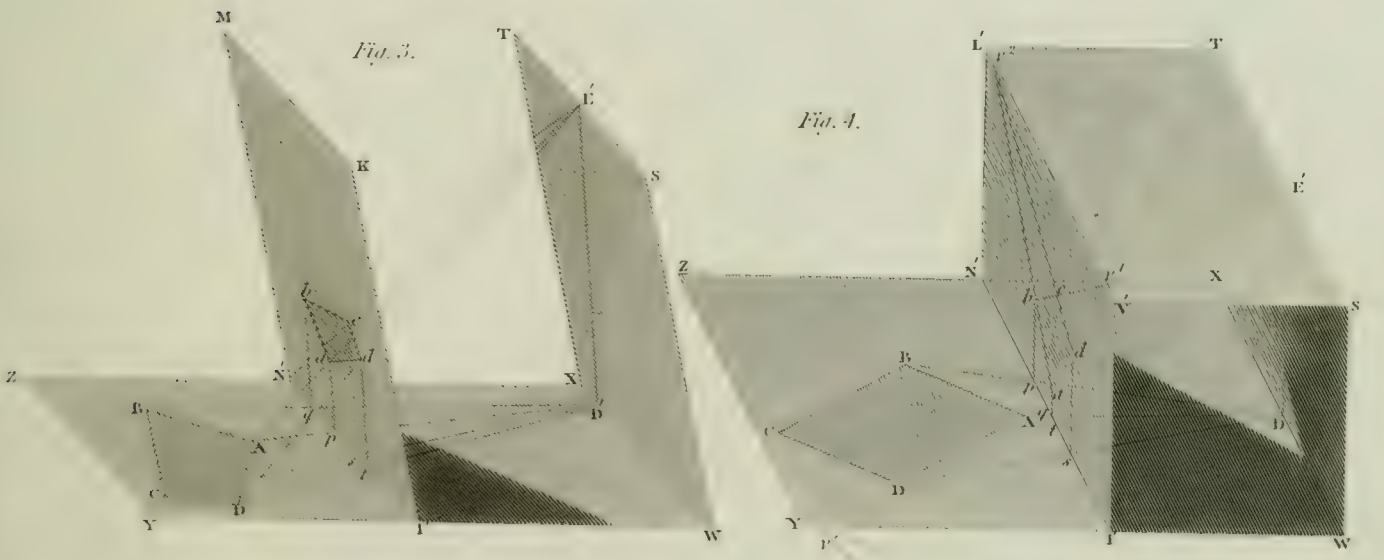
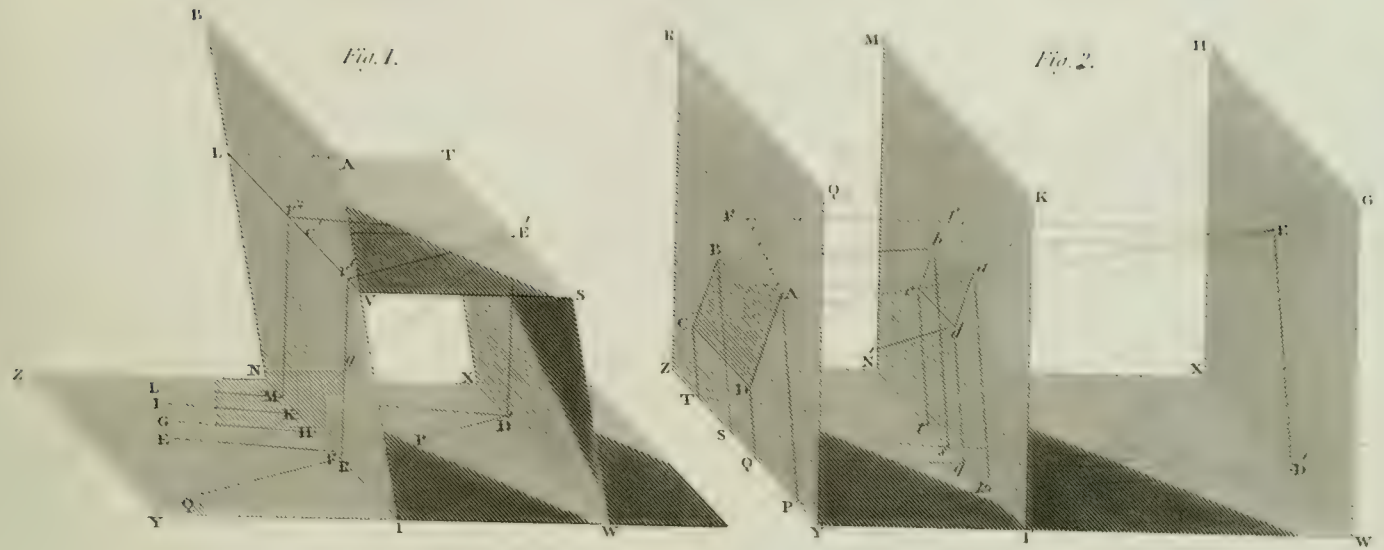

Fig. 2.

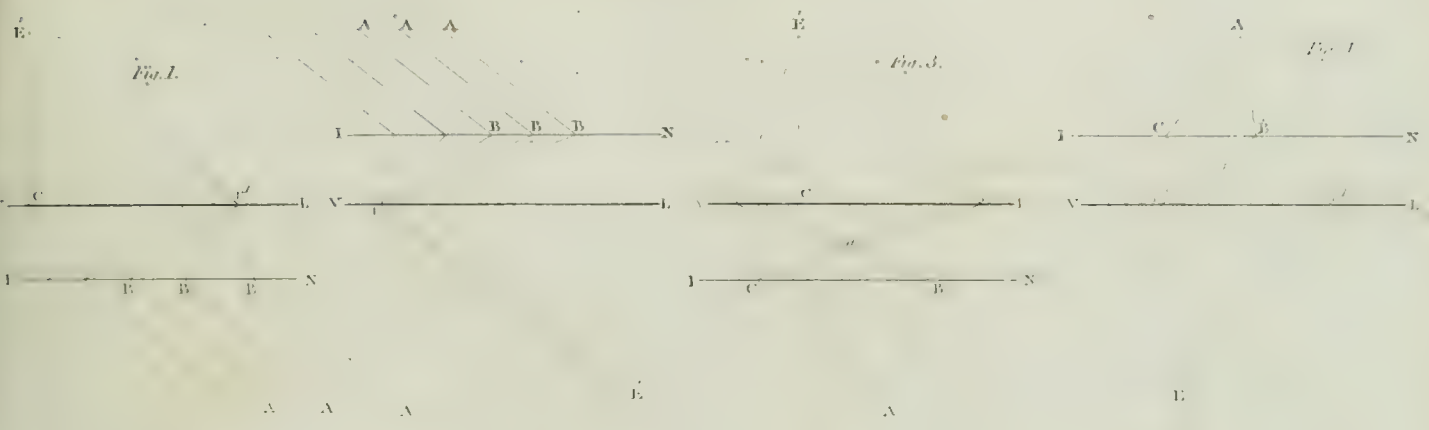

Fig. 5.

Fig. 6.

Fig. 7.

Fig. 8.

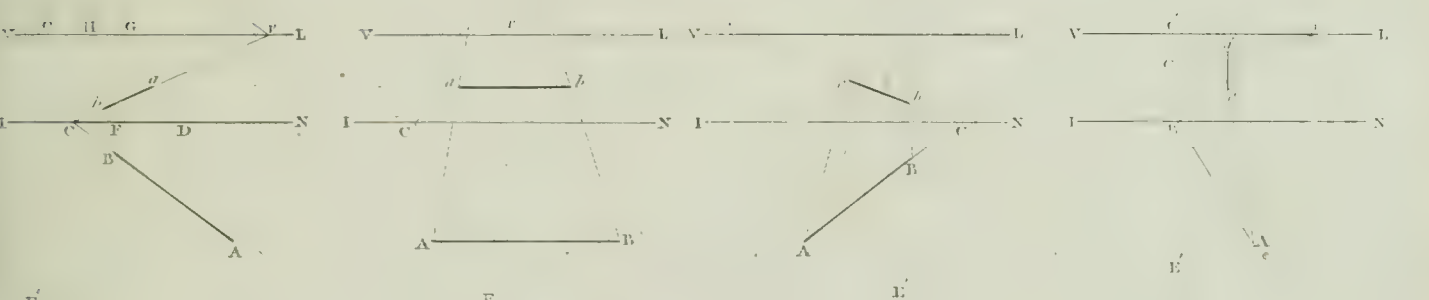

Fig. 9.

Fig. 10.

Fig. 11.

Fig. 12.

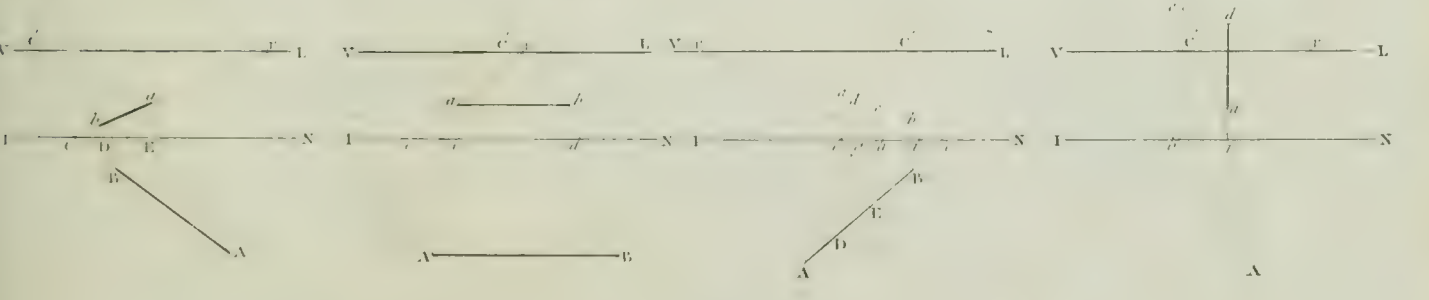

Fig. 13.

Fig. 14.

Fig. 15.

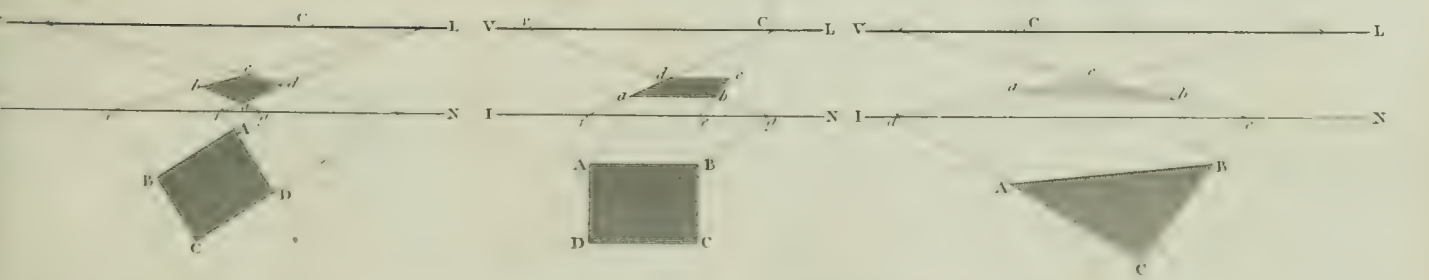

Fig. 2.

Fig. 3.

Fig. 1.

Fig. 4.

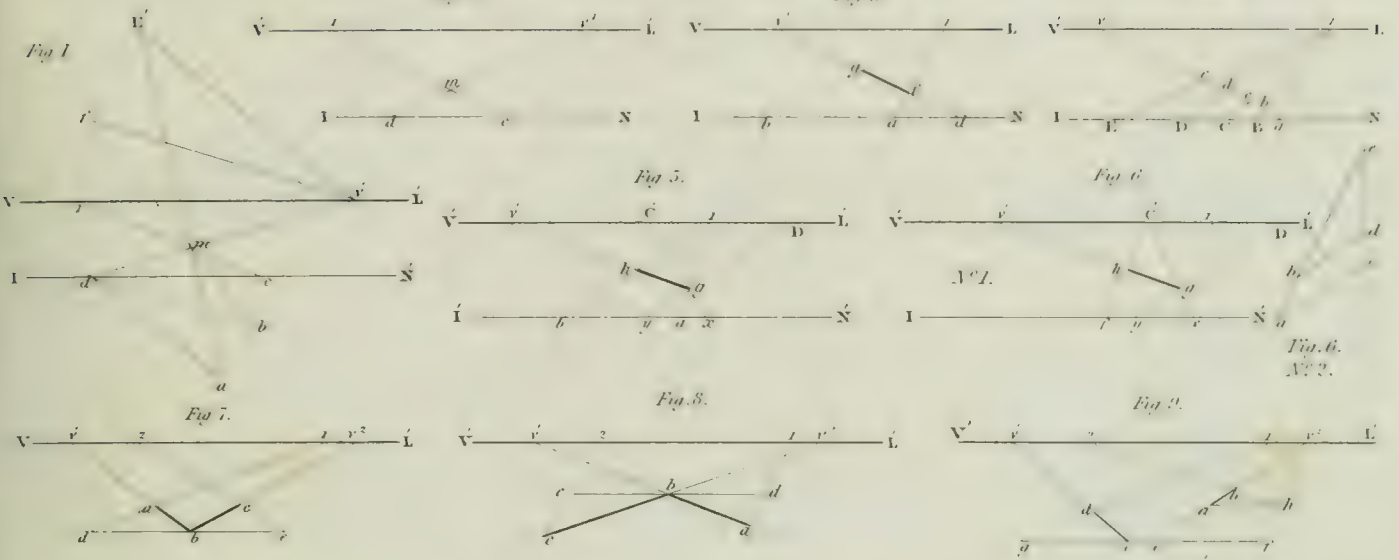

Fig. 11.

Fig. 10.

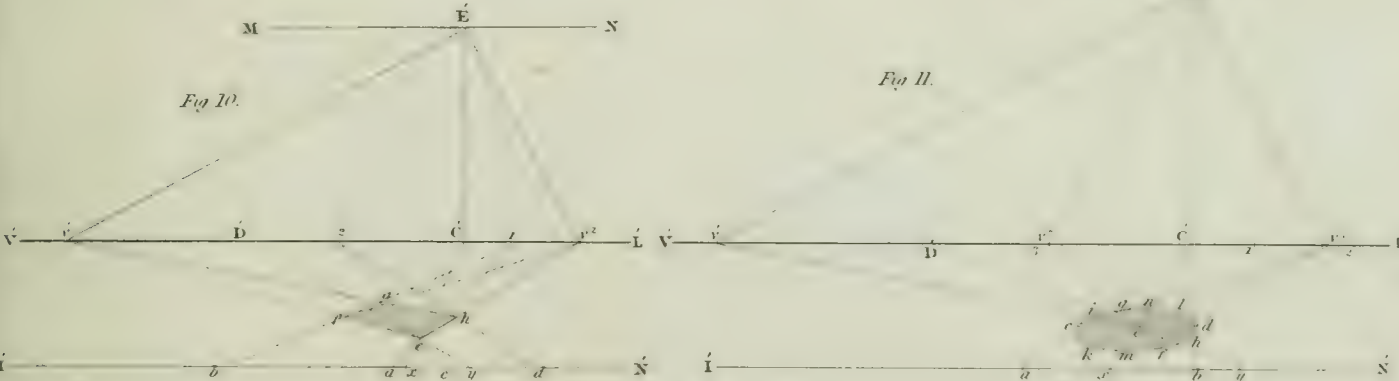

Fig. 14.

Fig. 12.

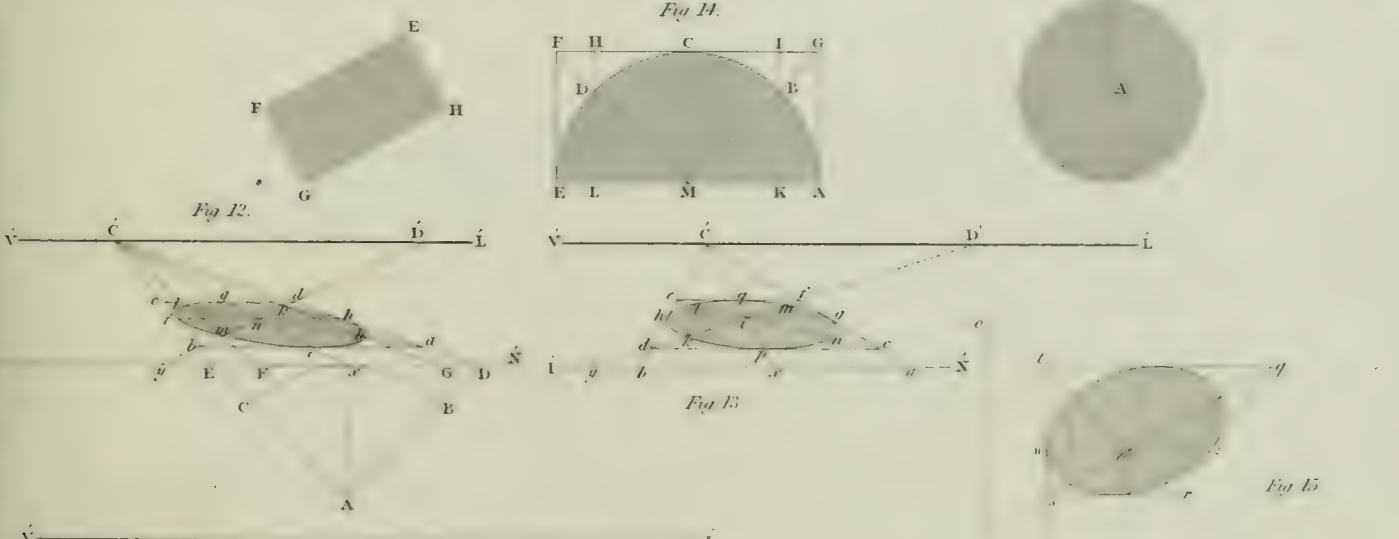
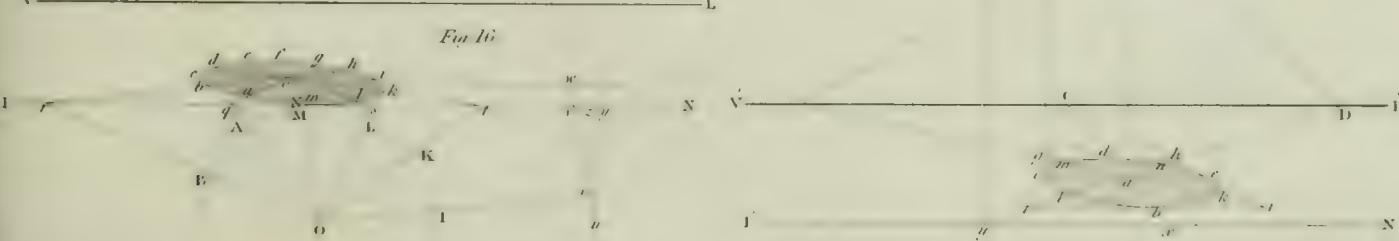
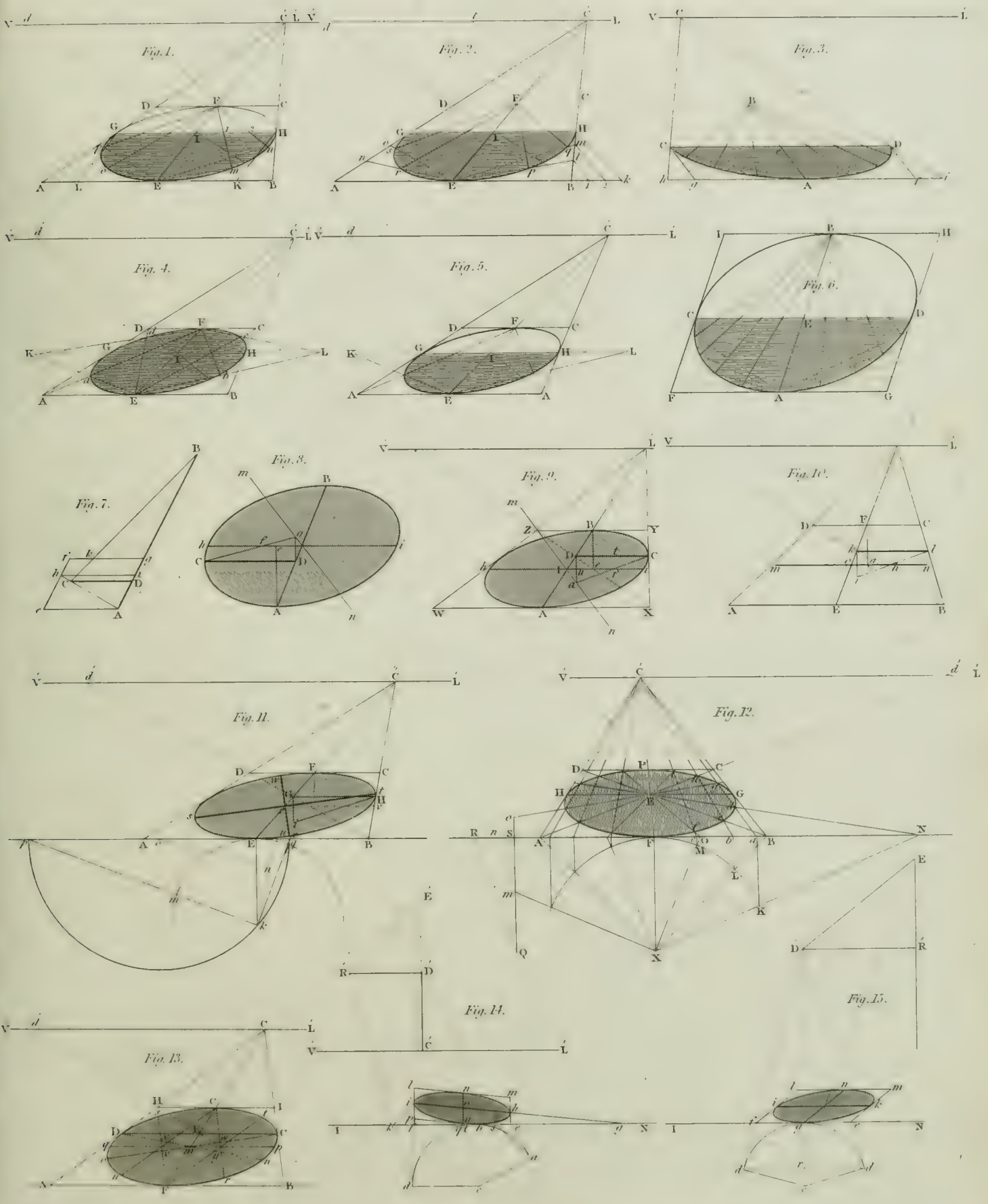

Fig. 13.

Fig. 15.

Fig. 16.





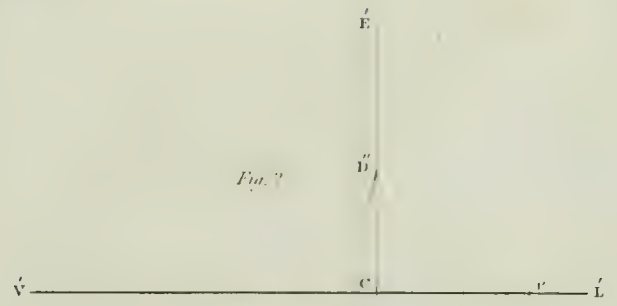
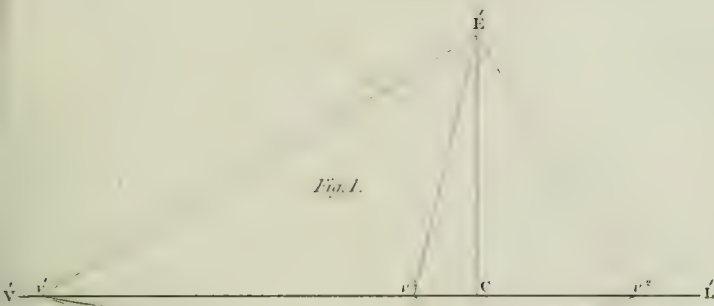

Invented by P.N.

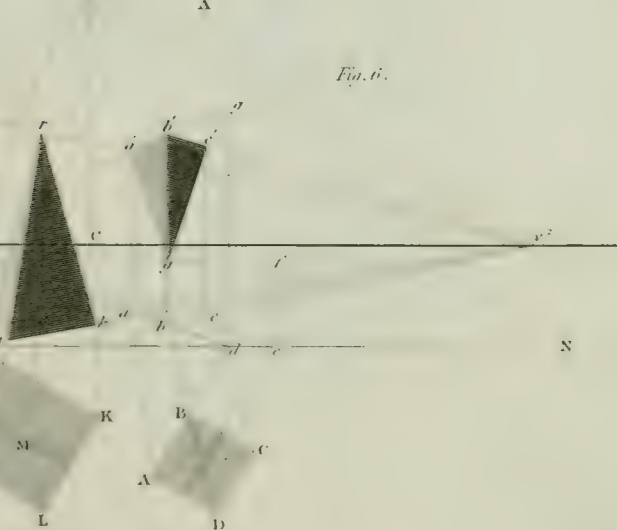
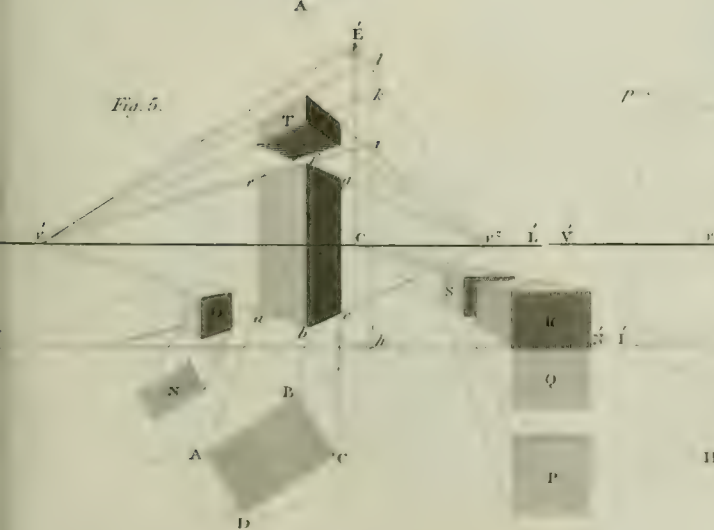
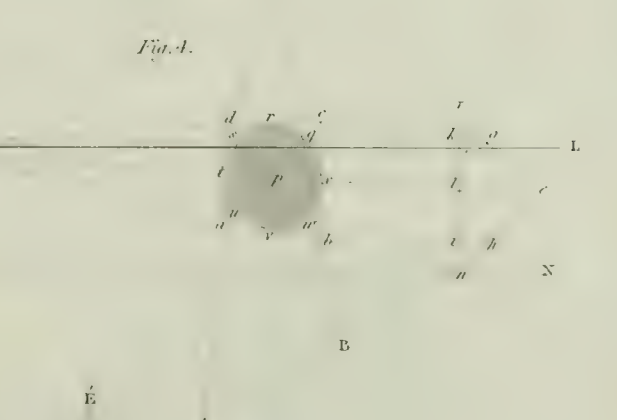
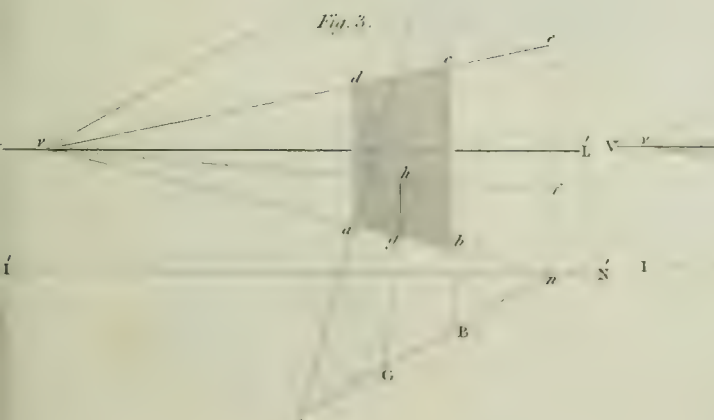
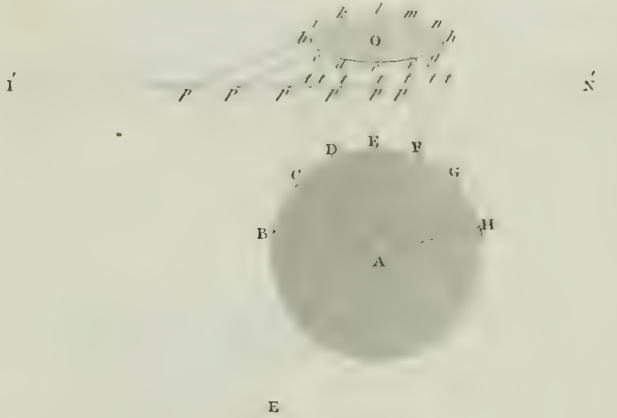
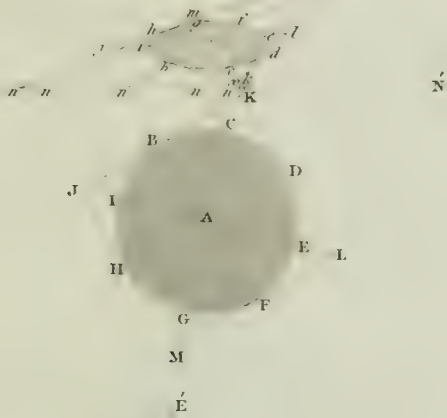

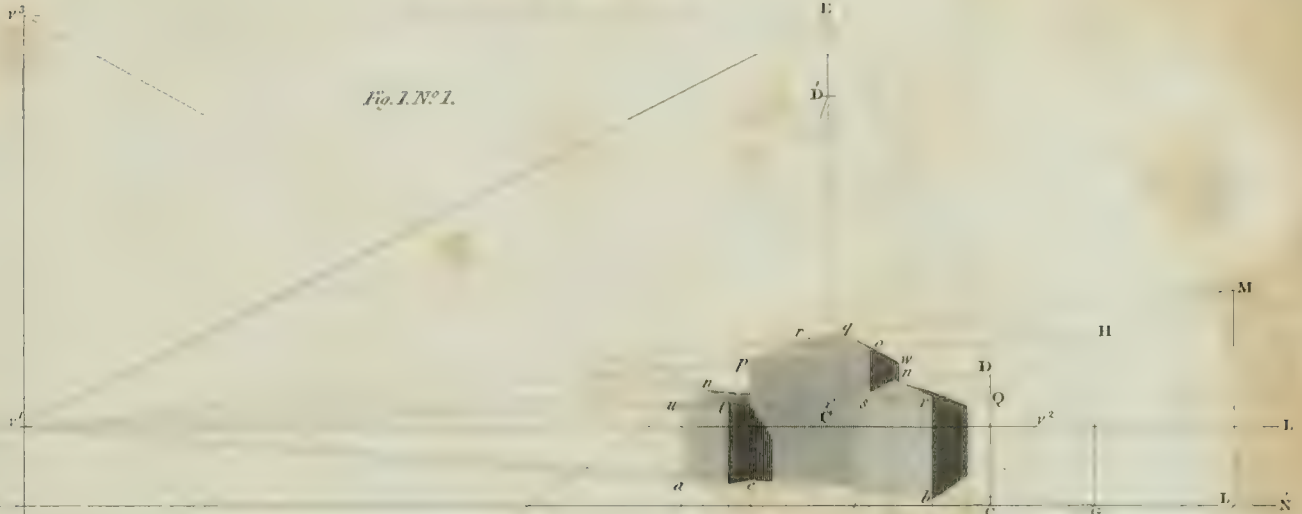

Fig. 1. N° 1.



Fig. 1. N° 3.

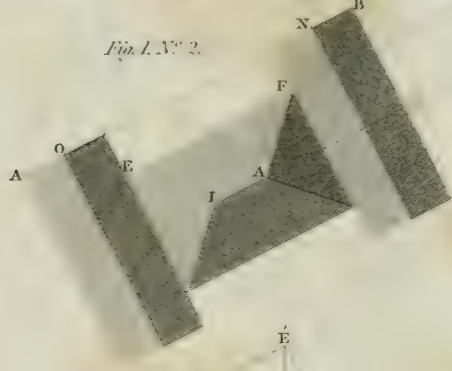

Fig. 1. N° 2.

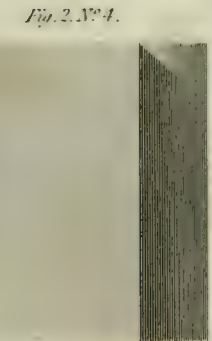

Fig. 2. N° 4.

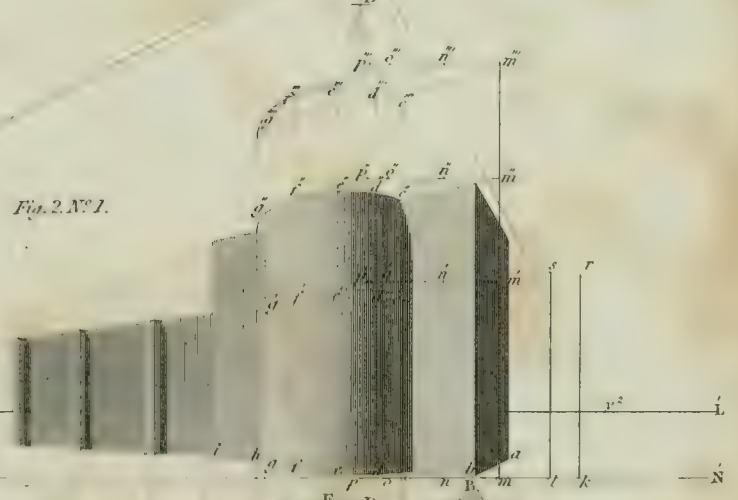

Fig. 2. N° 1.



Fig. 2. N° 3.

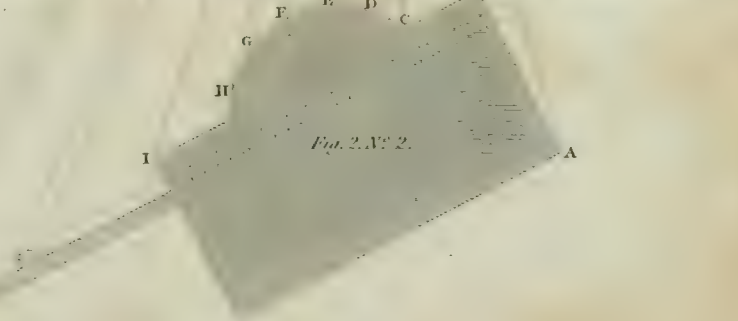

Fig. 2. N° 2.

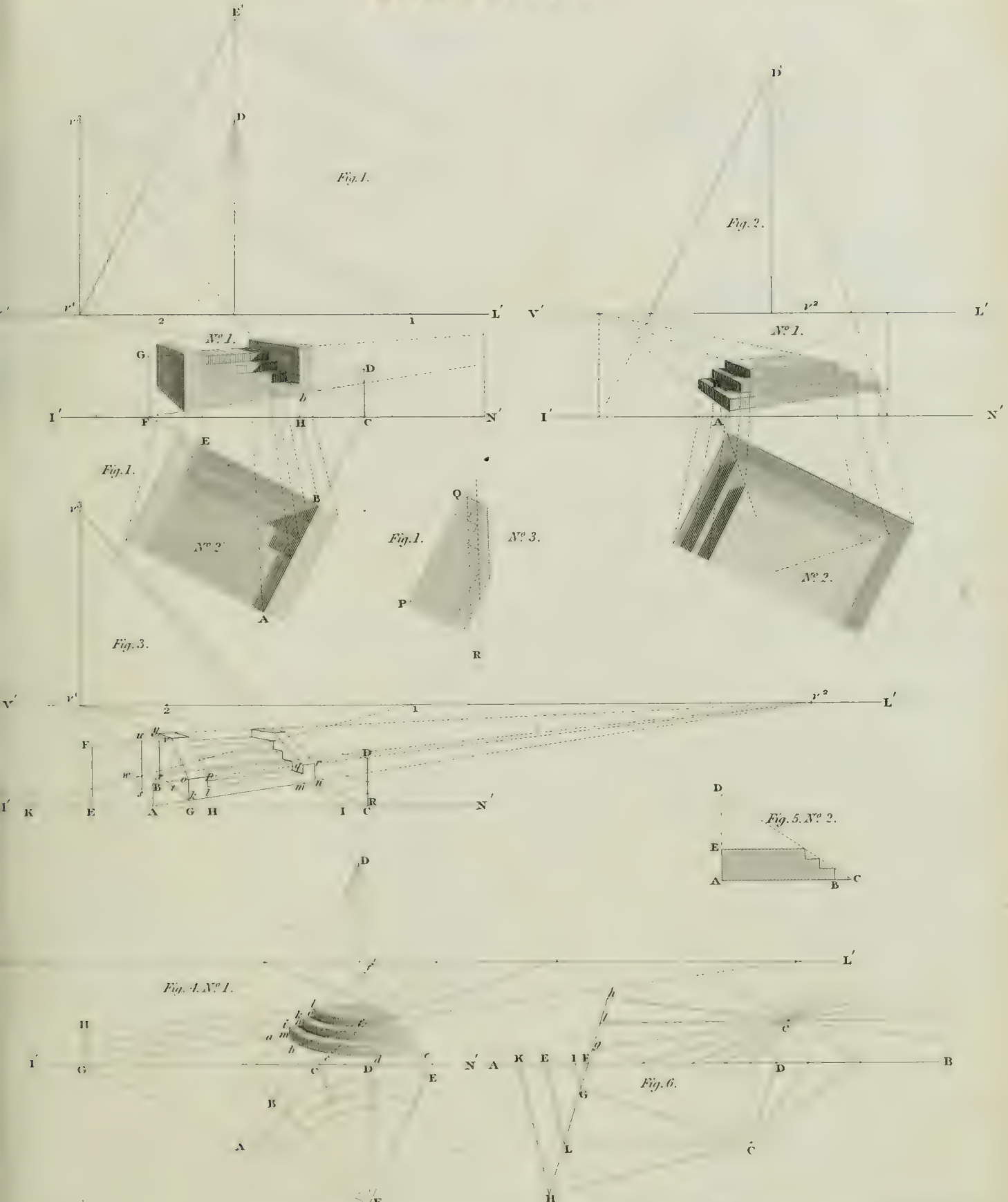

Fig. 1. N^o 1.

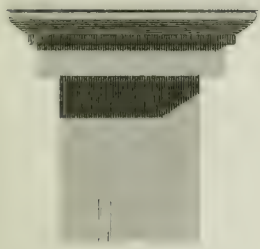

Fig. 1. N^o 2.

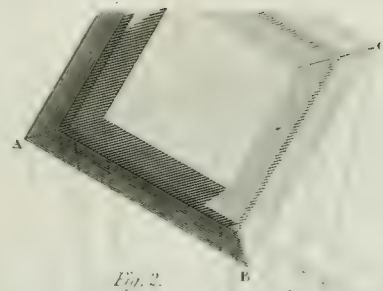
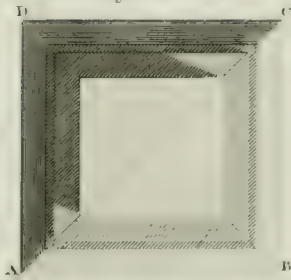

Fig. 2.

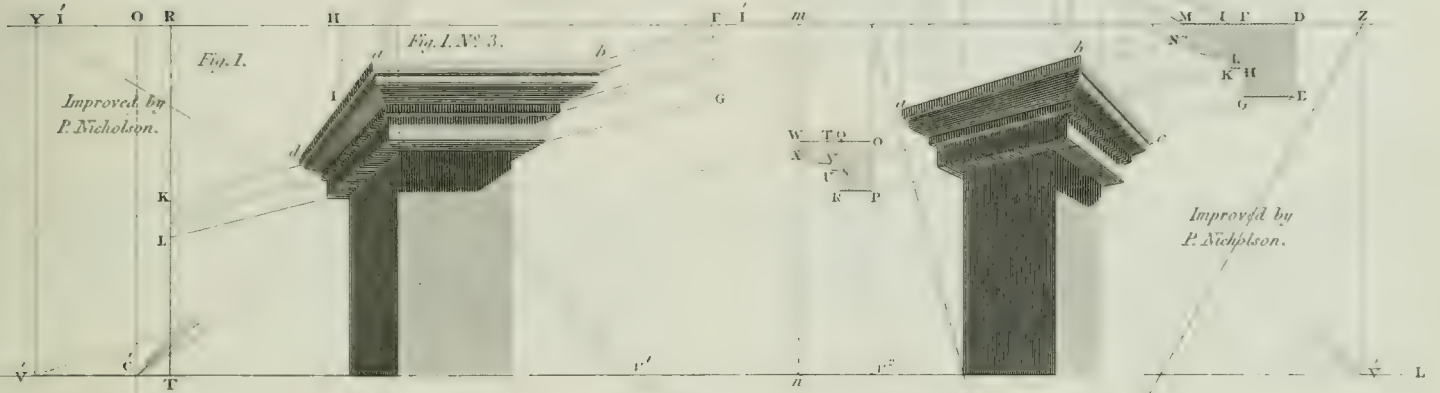

Fig. 3.

Invented by Nicholson.

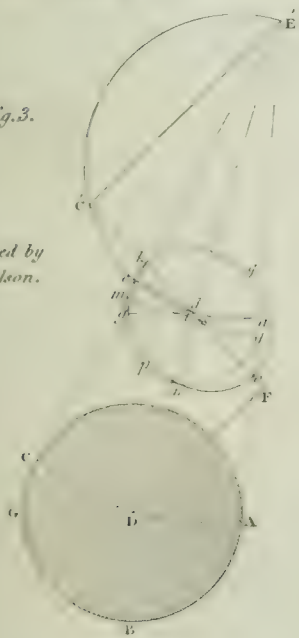

Fig. 4. Invented by P. Nicholson.

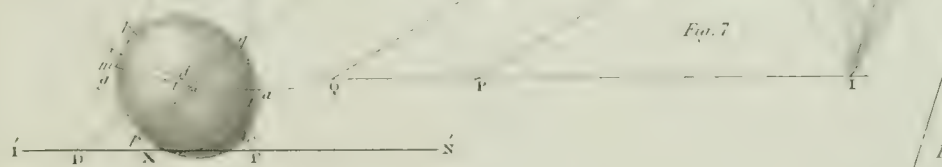
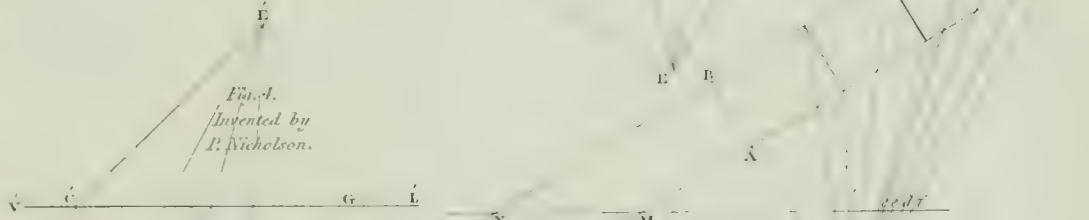

Fig. 5.

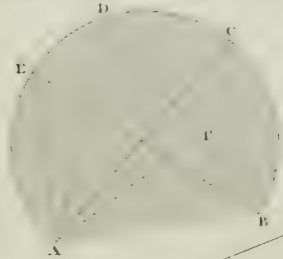

Fig. 6. N^o 1. Invented by P. Nicholson.

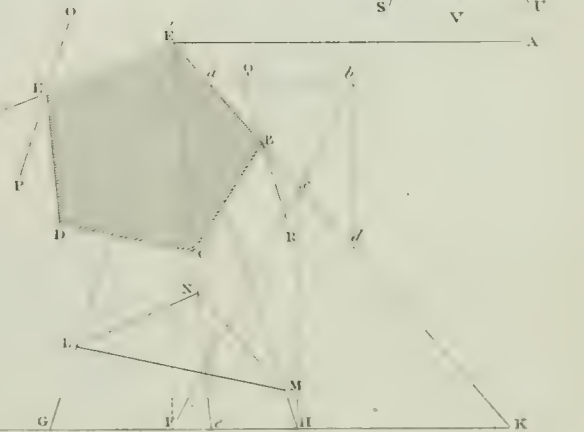
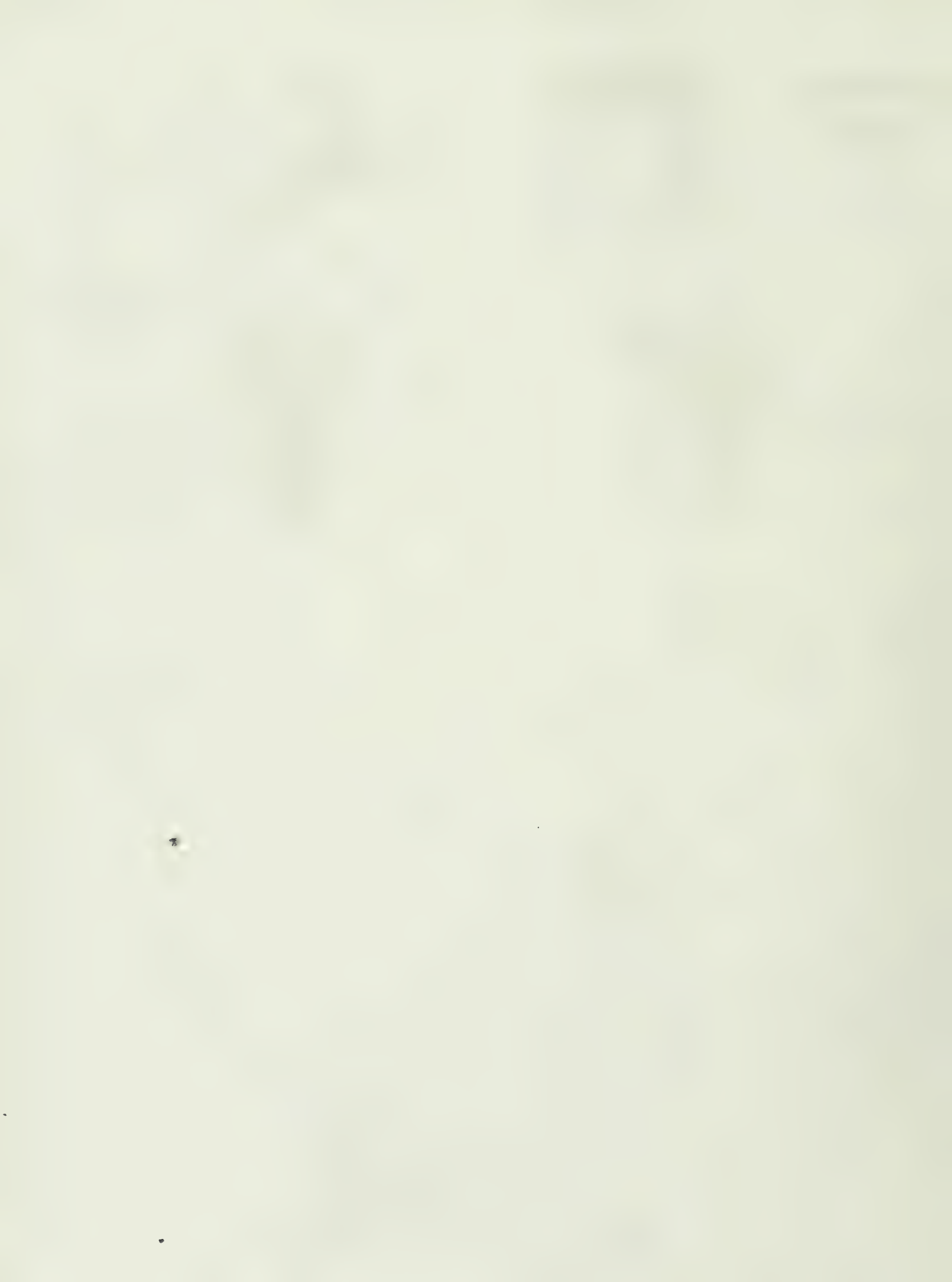
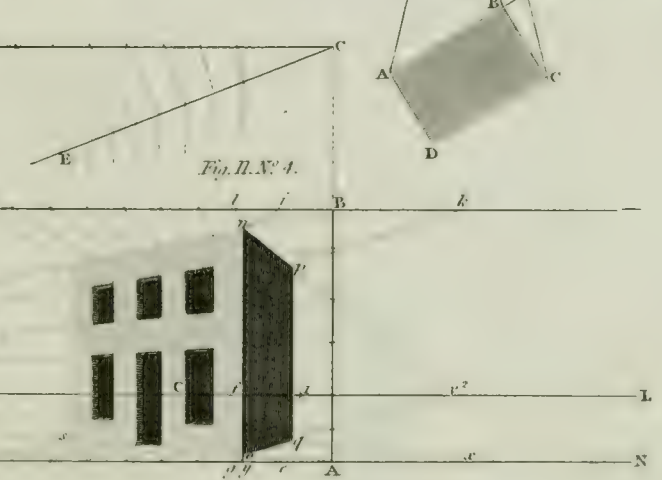
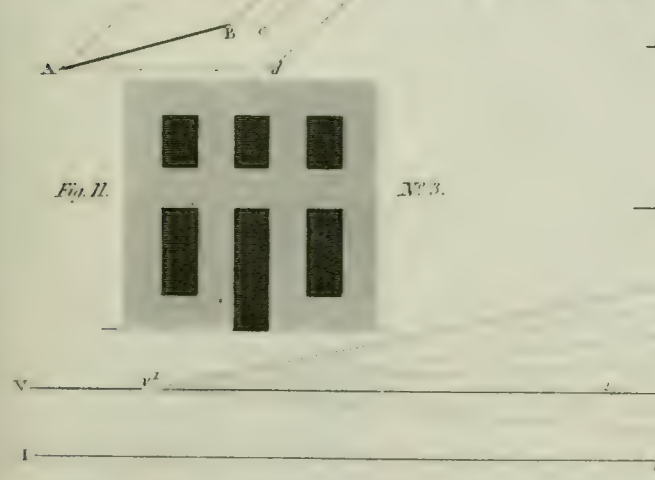
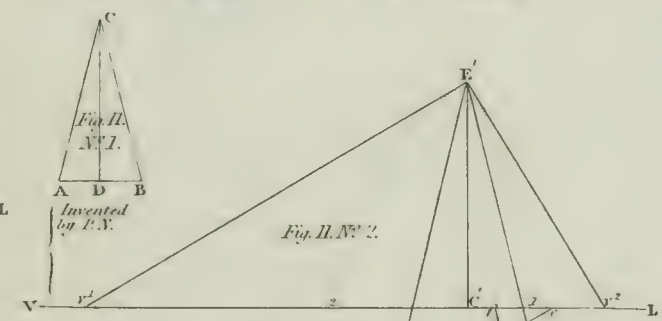
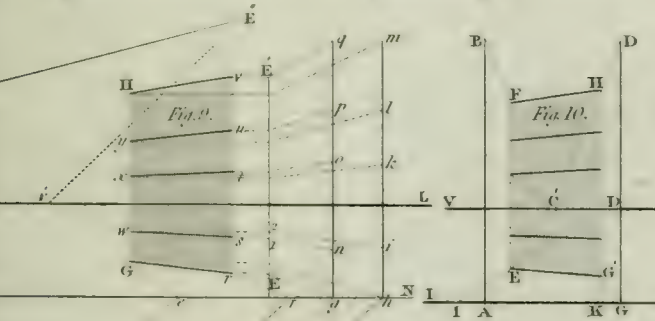
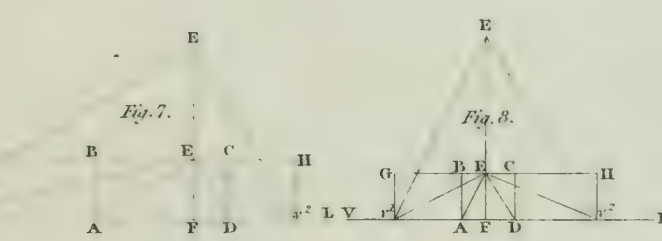
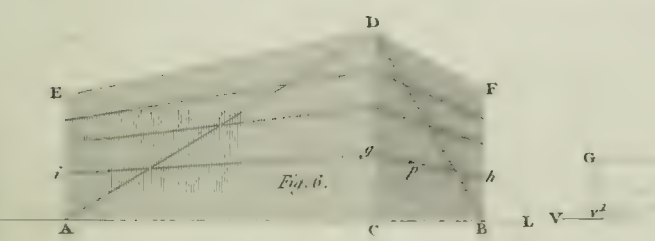
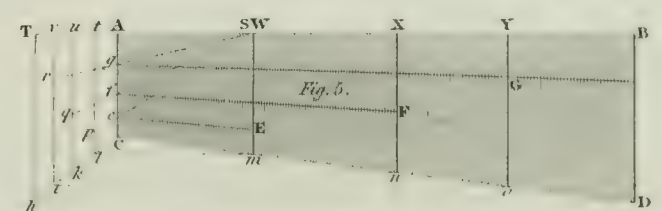
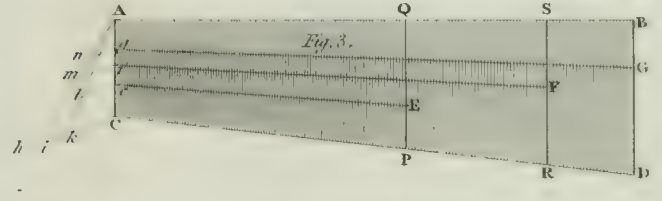
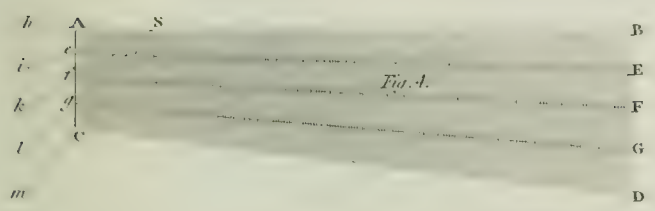
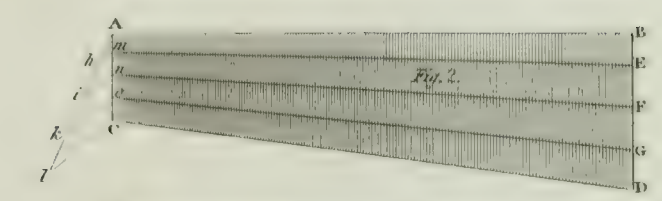
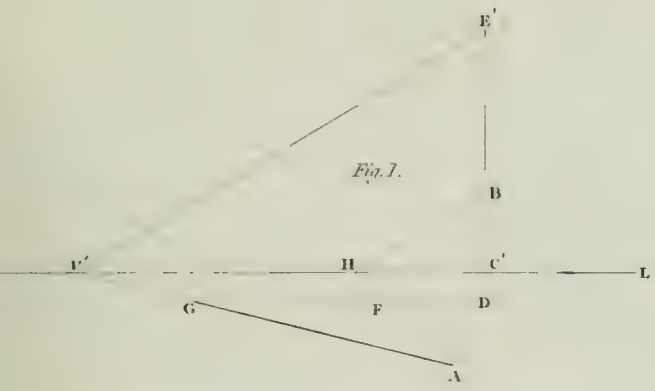
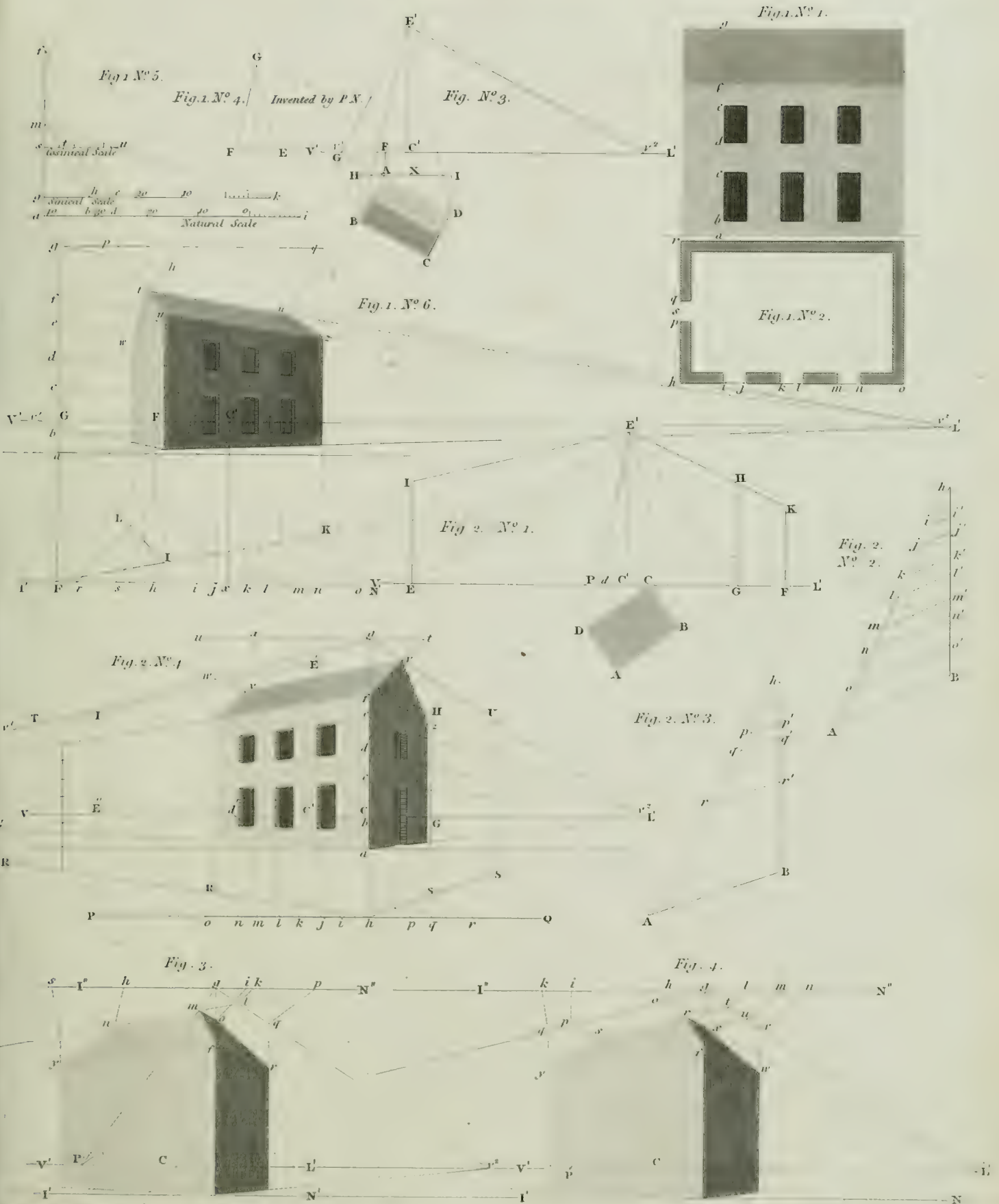

Fig. 6. N^o 2.







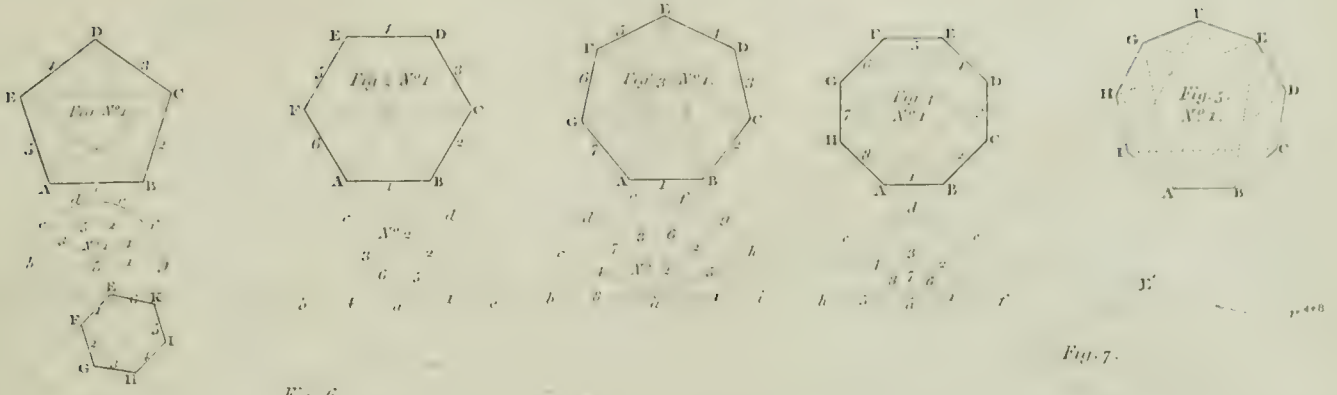

Fig. 6.

Fig. 7.

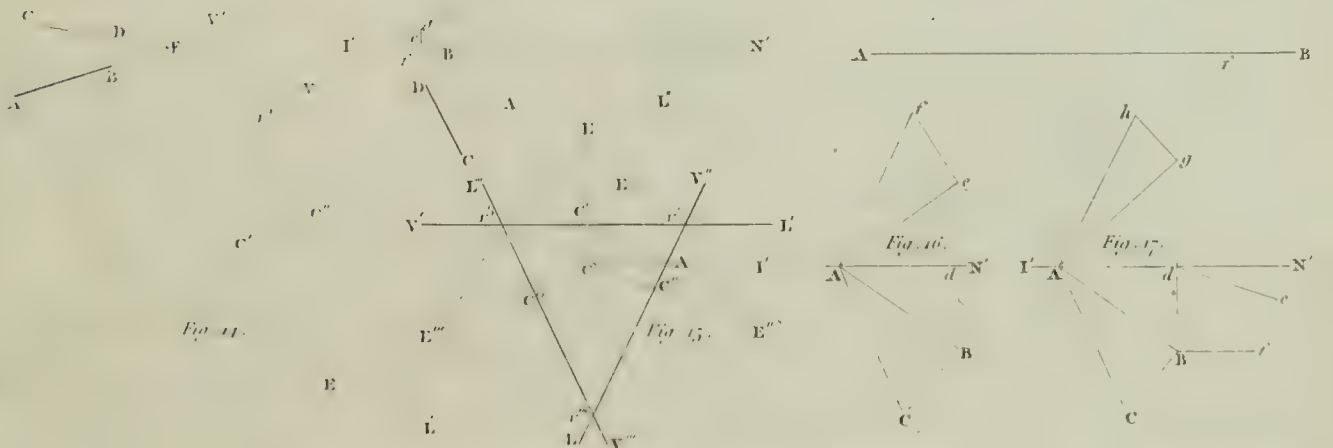
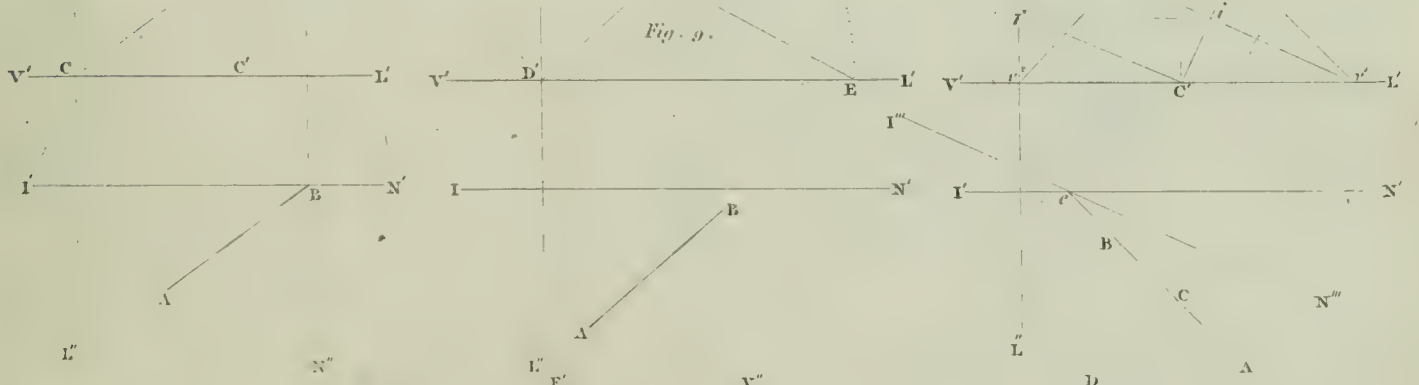
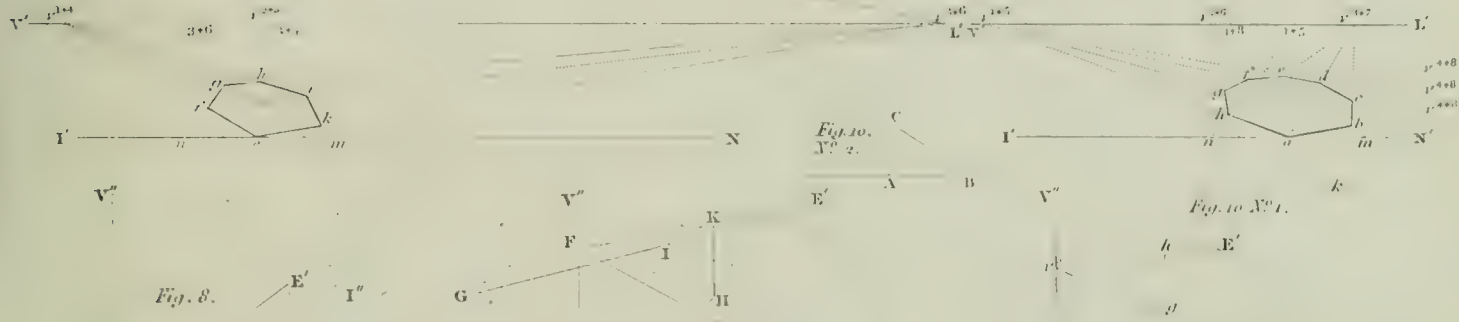

Fig. 1.

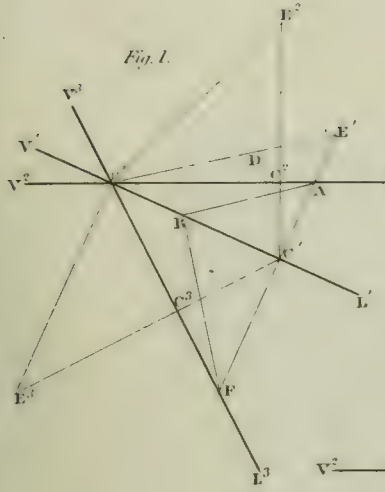

Fig. 2.

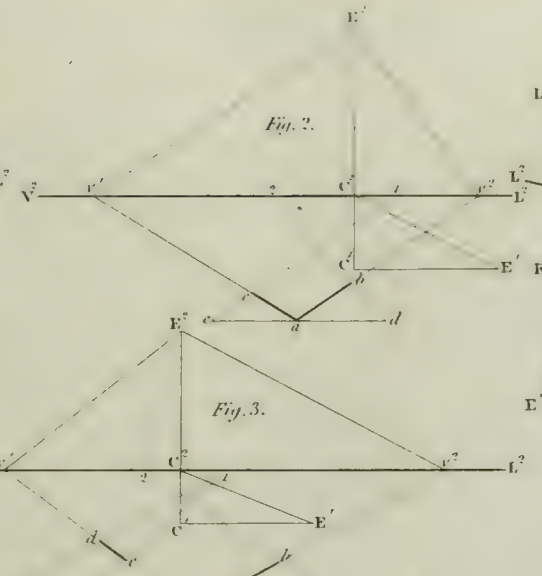

Fig. 1.

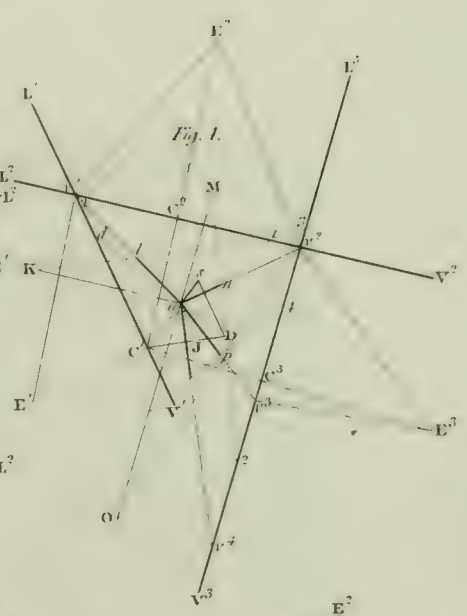

Fig. 3.

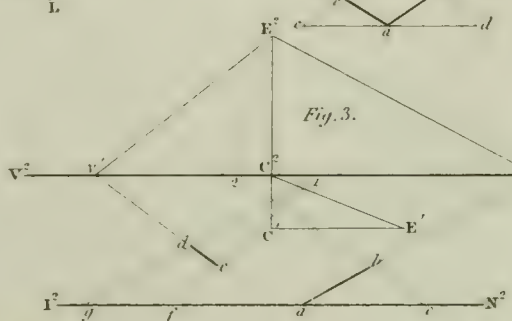

Fig. 5.

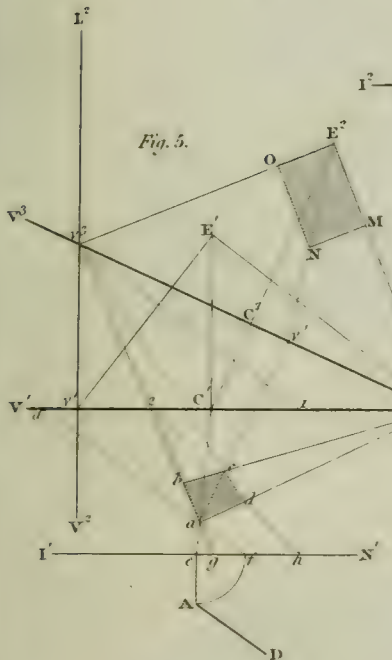

Fig. 6.

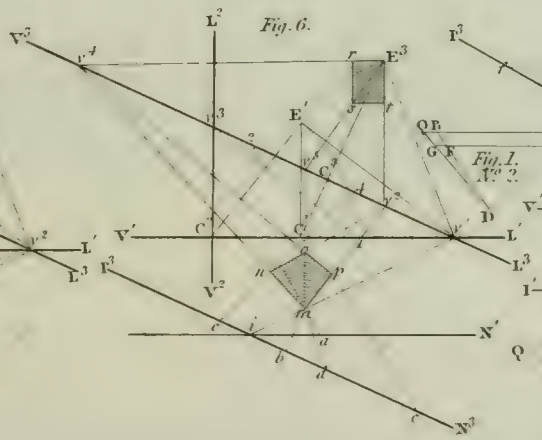

Fig. 7. N° 1.

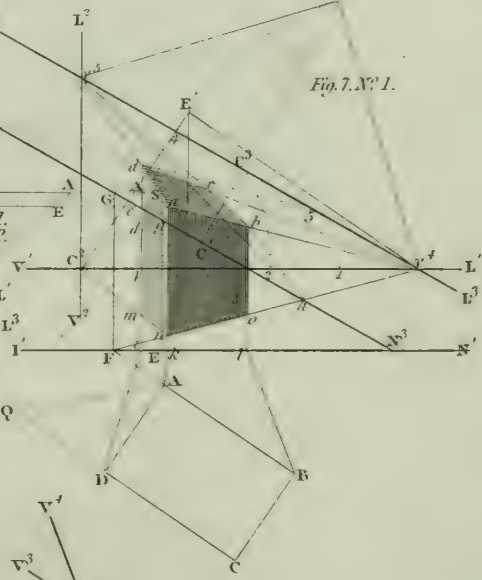

Fig. 8.

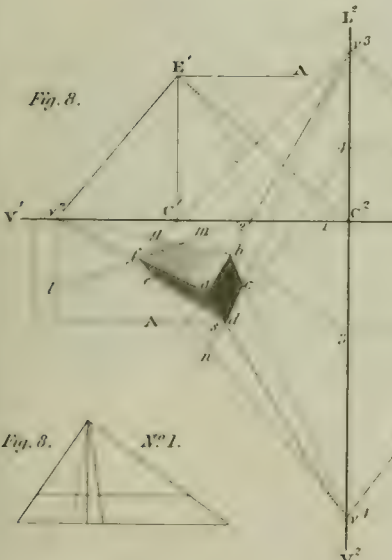

Fig. 9.

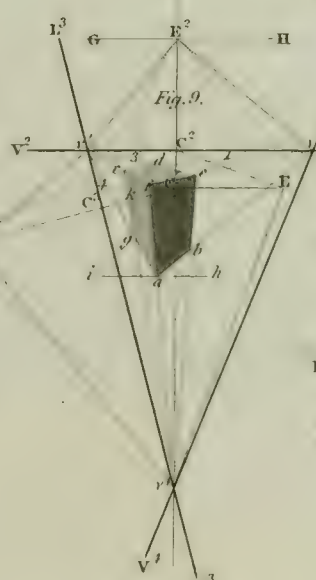

Fig. 10.

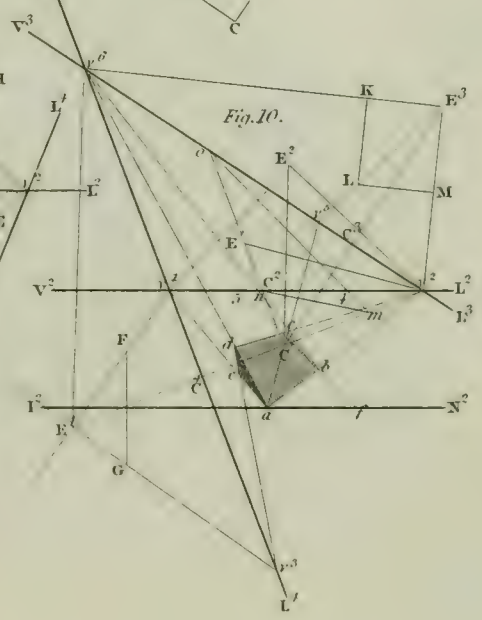
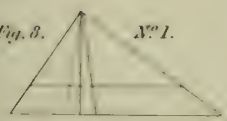

Fig. 8. N° 1.



PLANETARY MACHINES.

COMETARIUM.

Fig. 1.

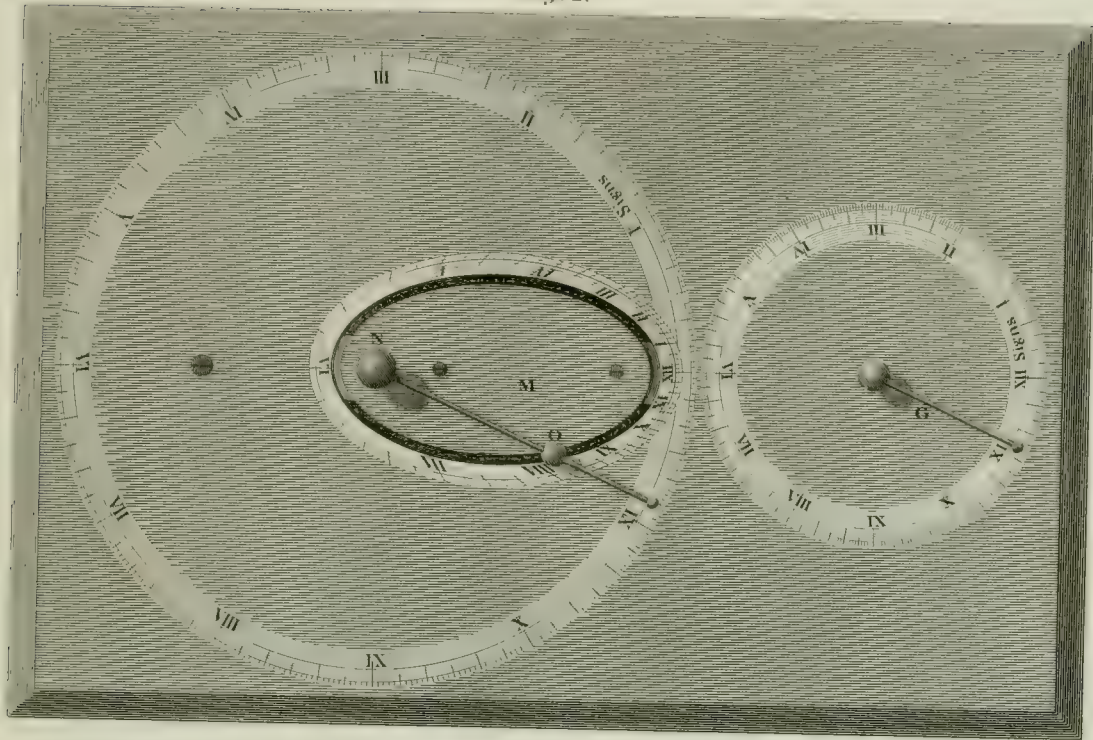
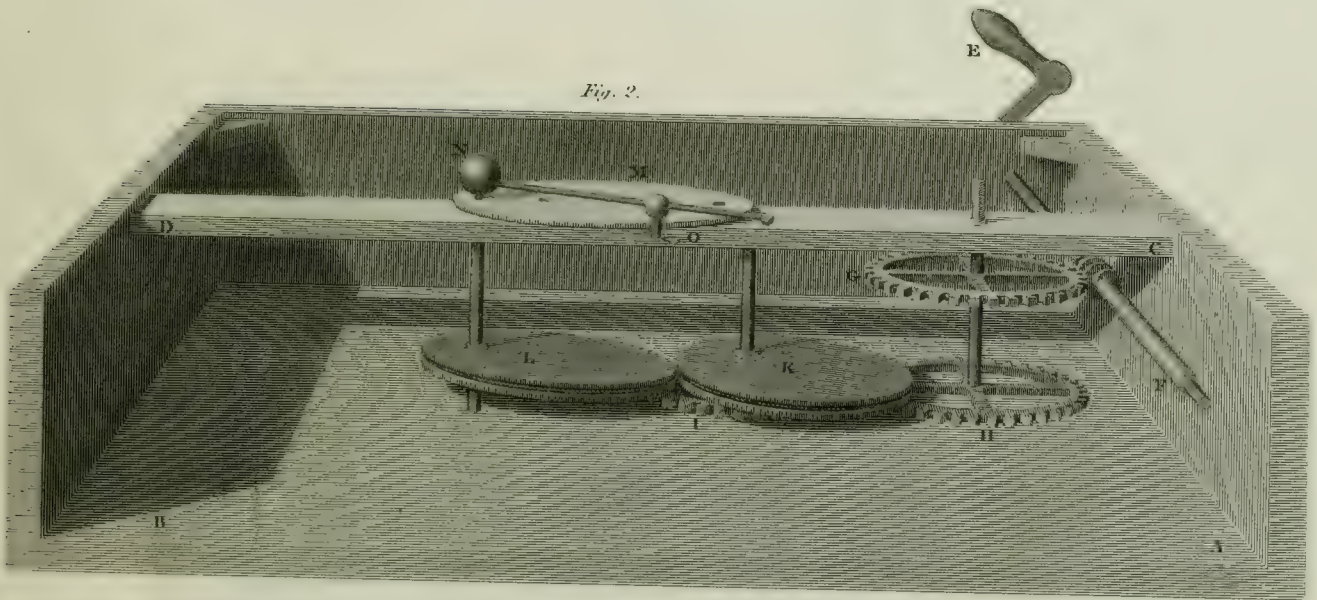
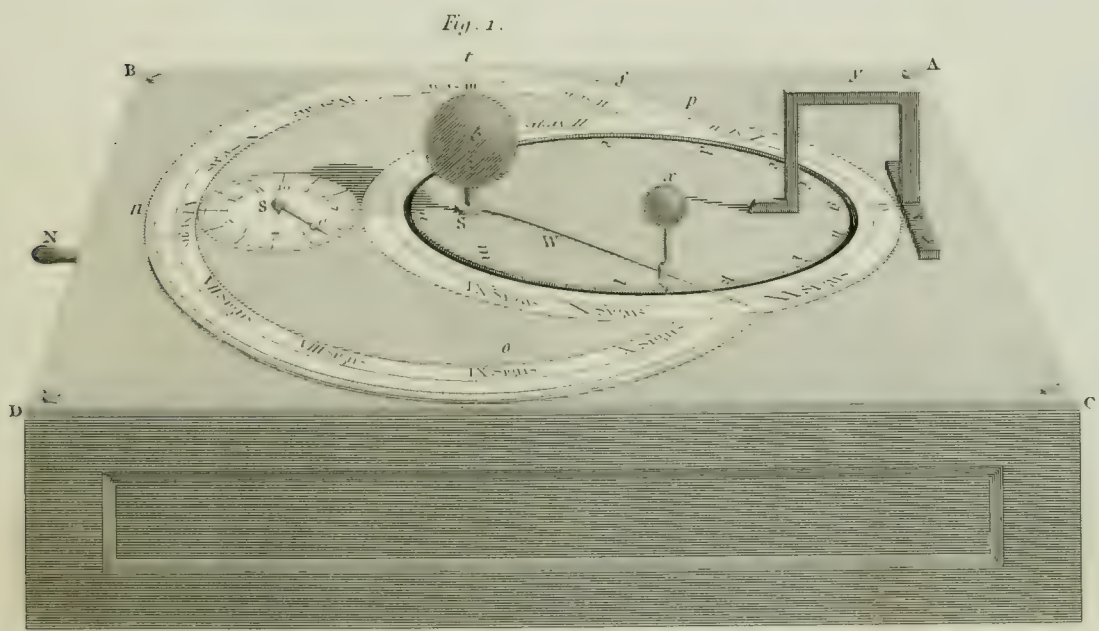
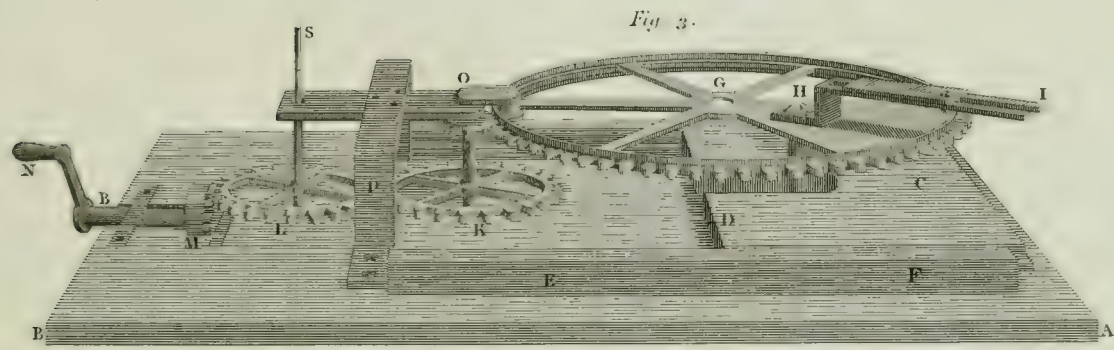
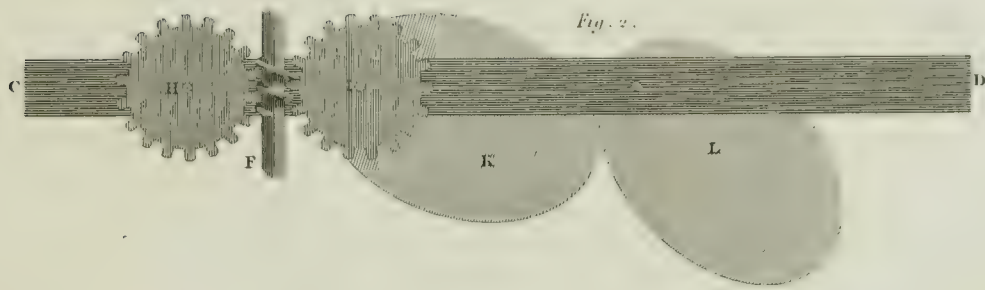

Fig. 2.



COMETARIUM,

by W. Jones.



PLANETARY MACHINES.
EQUATION MECHANISM OF A PLANET'S ORBIT.

By M^r Huygens.

Fig. 1.

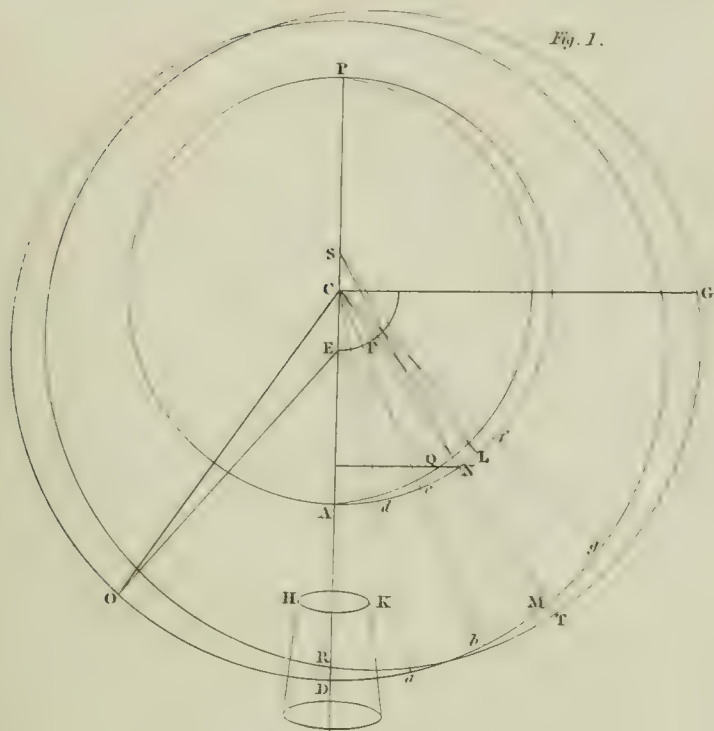

By M^r Jos. Priestley.

Fig. 2.

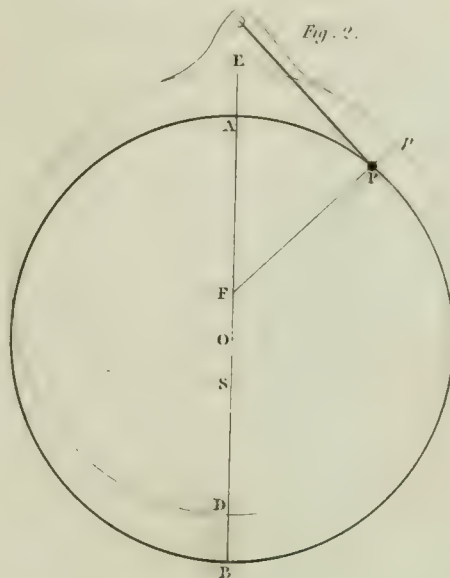

By the Rev^d W. Pearson.

Fig. 4.

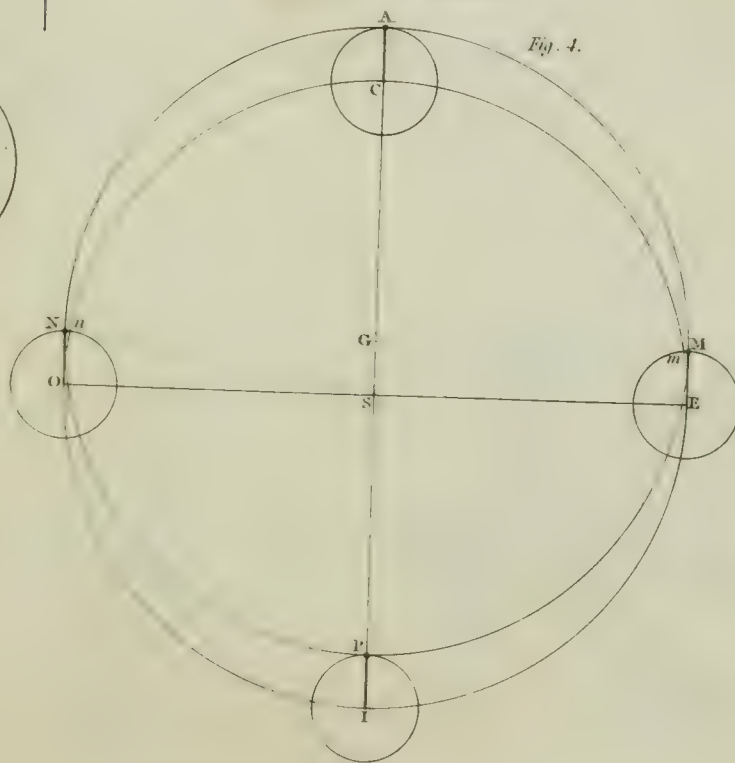

Fig. 5.

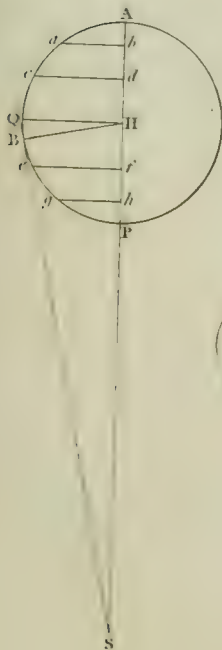
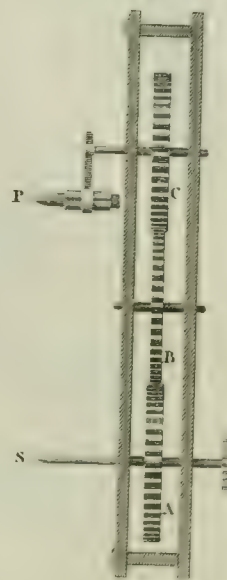

Fig. 3.



PLANETARY MACHINES,
 EQUATION MECHANISM OF A PLANET'S ORBIT.
 By the Rev.^d W. Pearson.

Fig. 1.

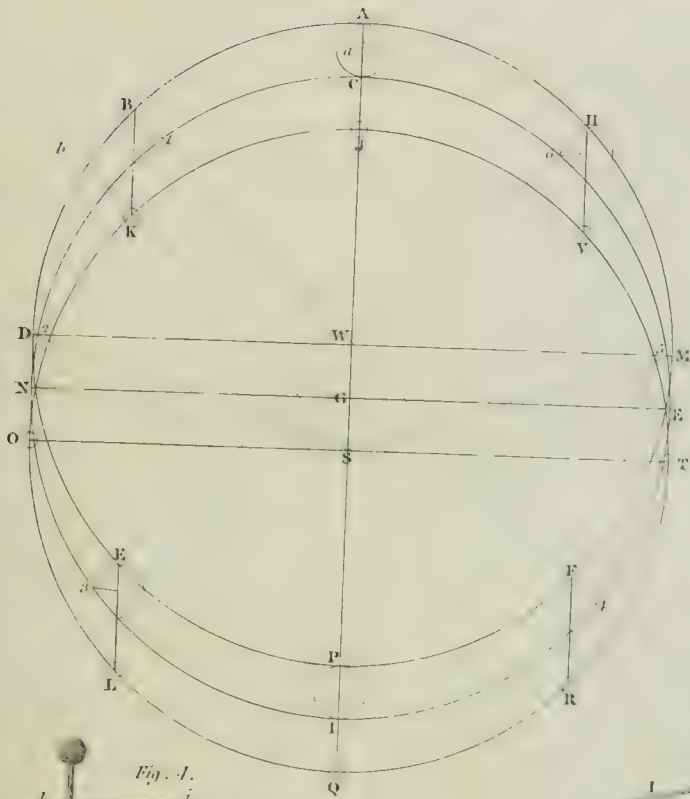

Fig. 2.

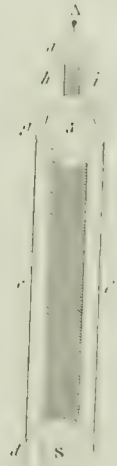

Fig. 3.

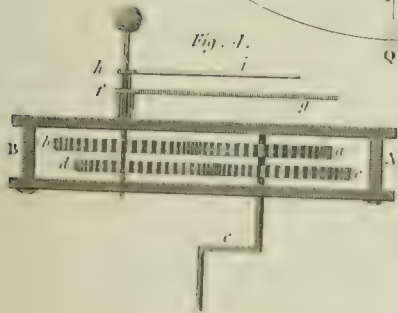

Fig. 4.

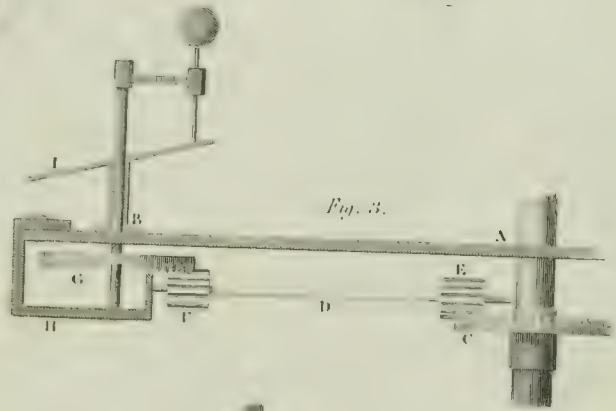

Fig. 5.

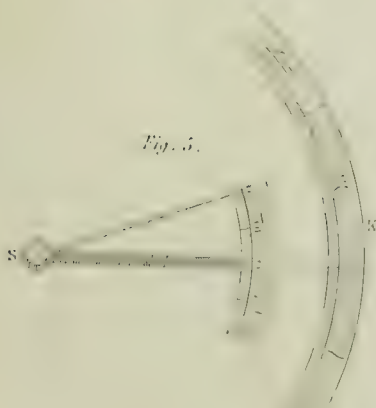
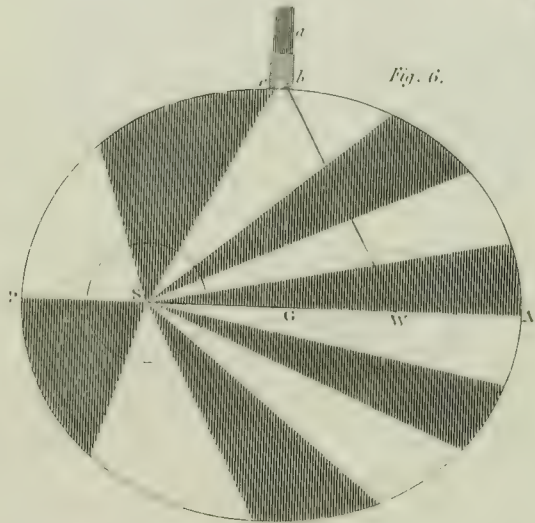
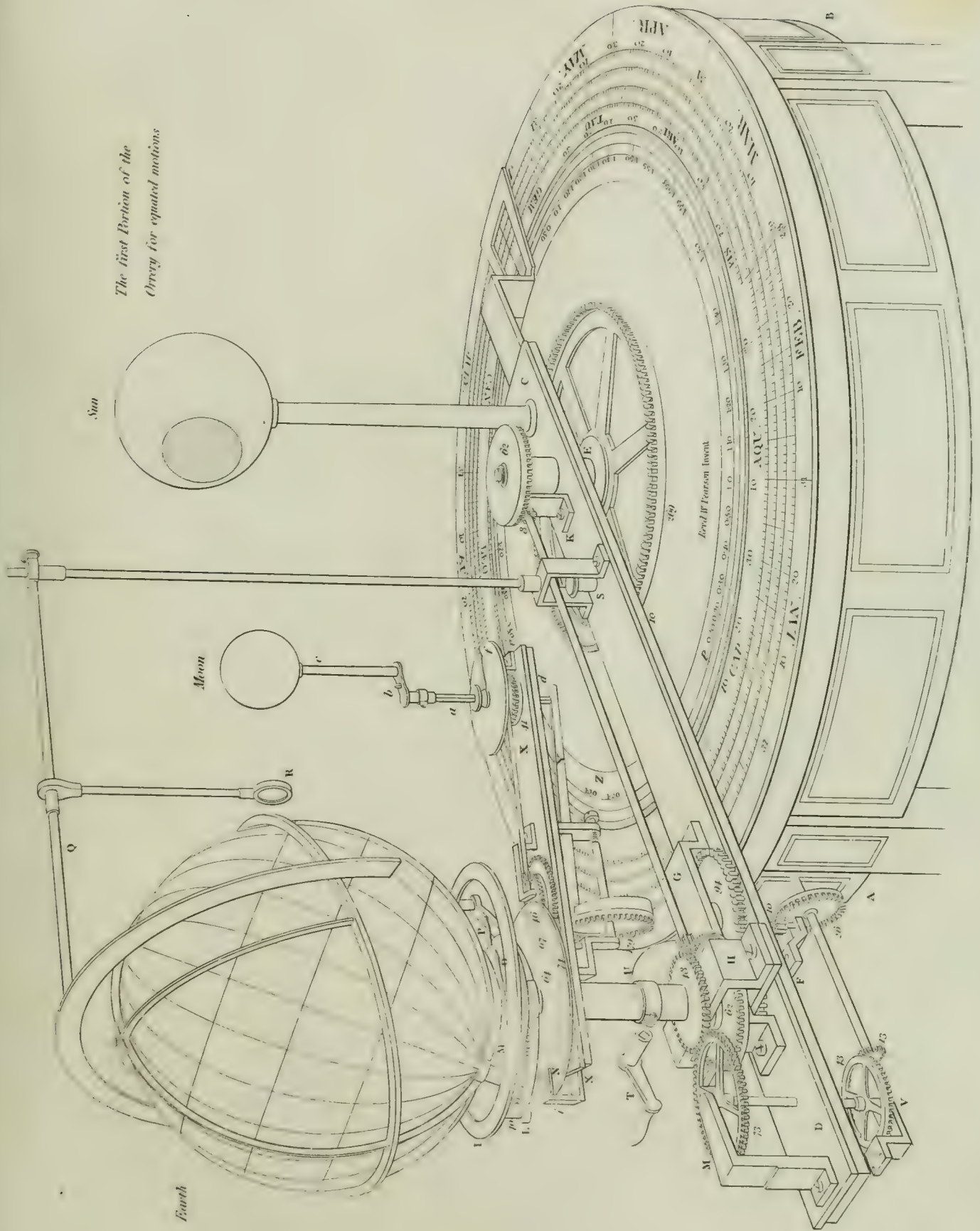
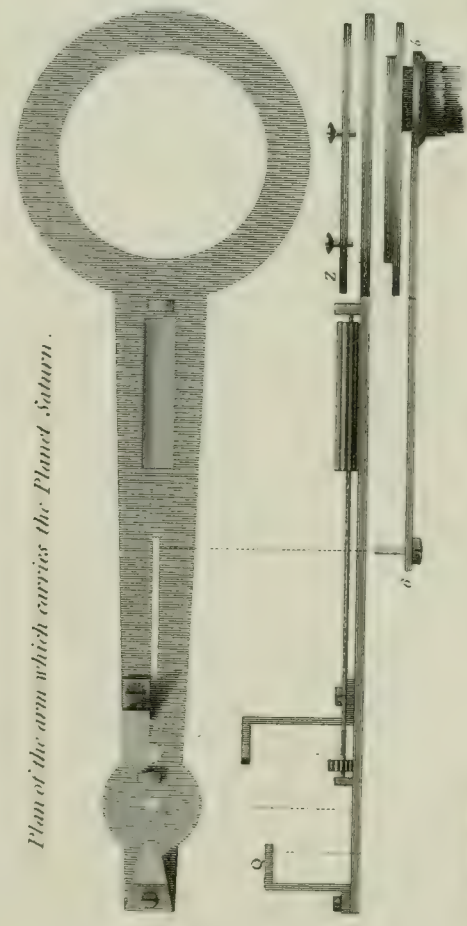
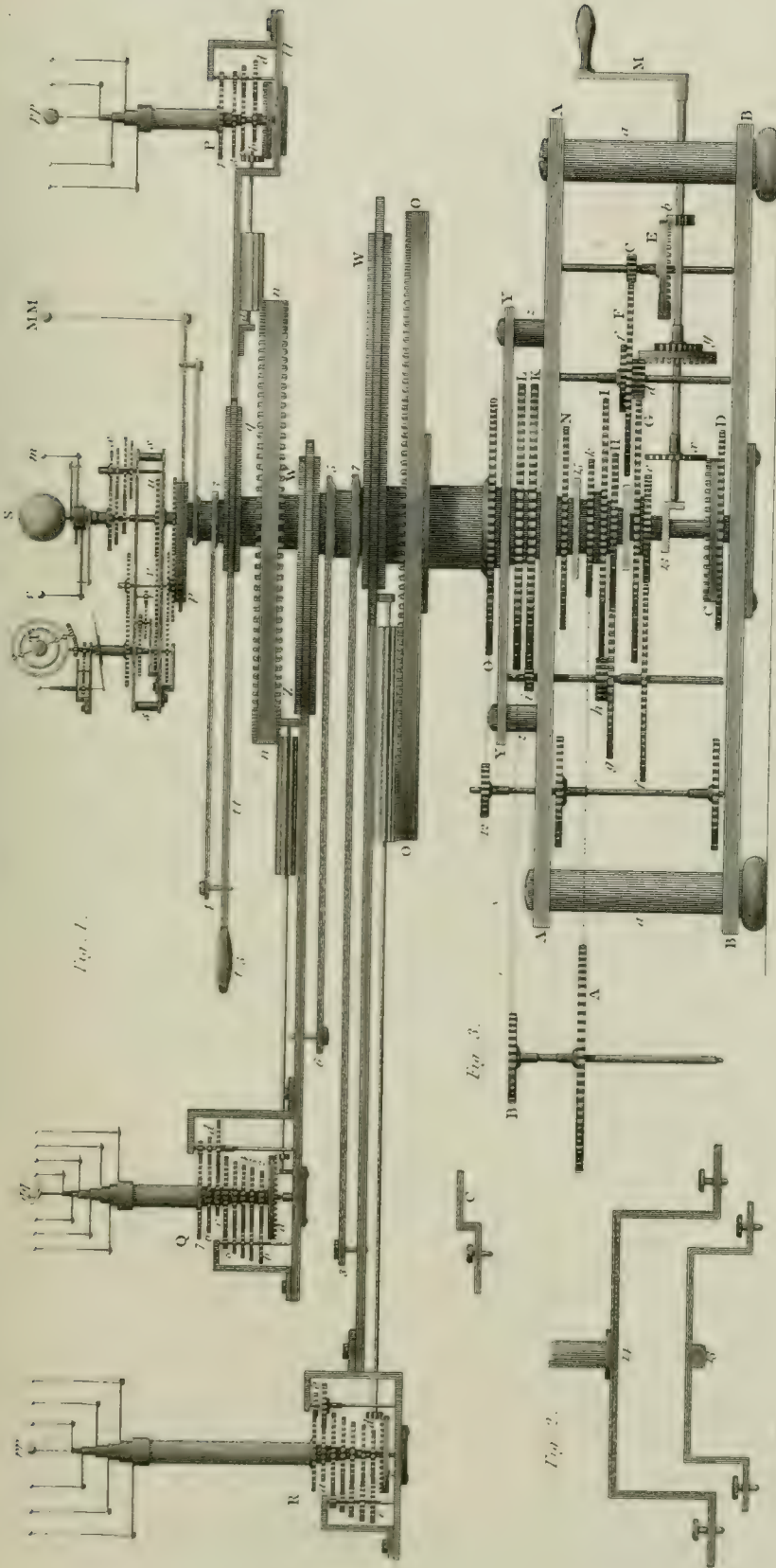

Fig. 6.



The first Portion of the
Orrey for equated motions





Plan of the arm which carries the Planet Saturn.

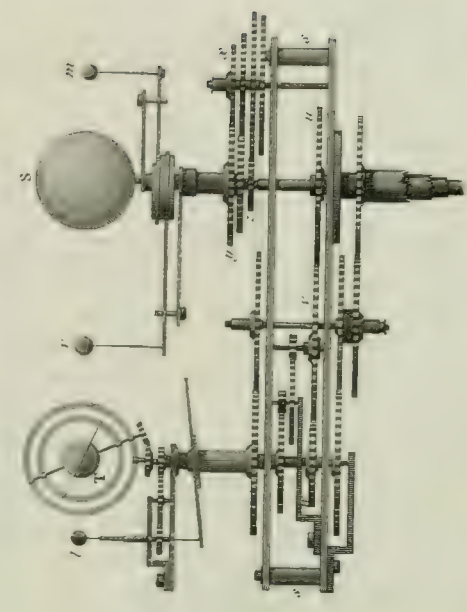

PLANETARY MACHINES

Section of the improved ORREY for mean motions.

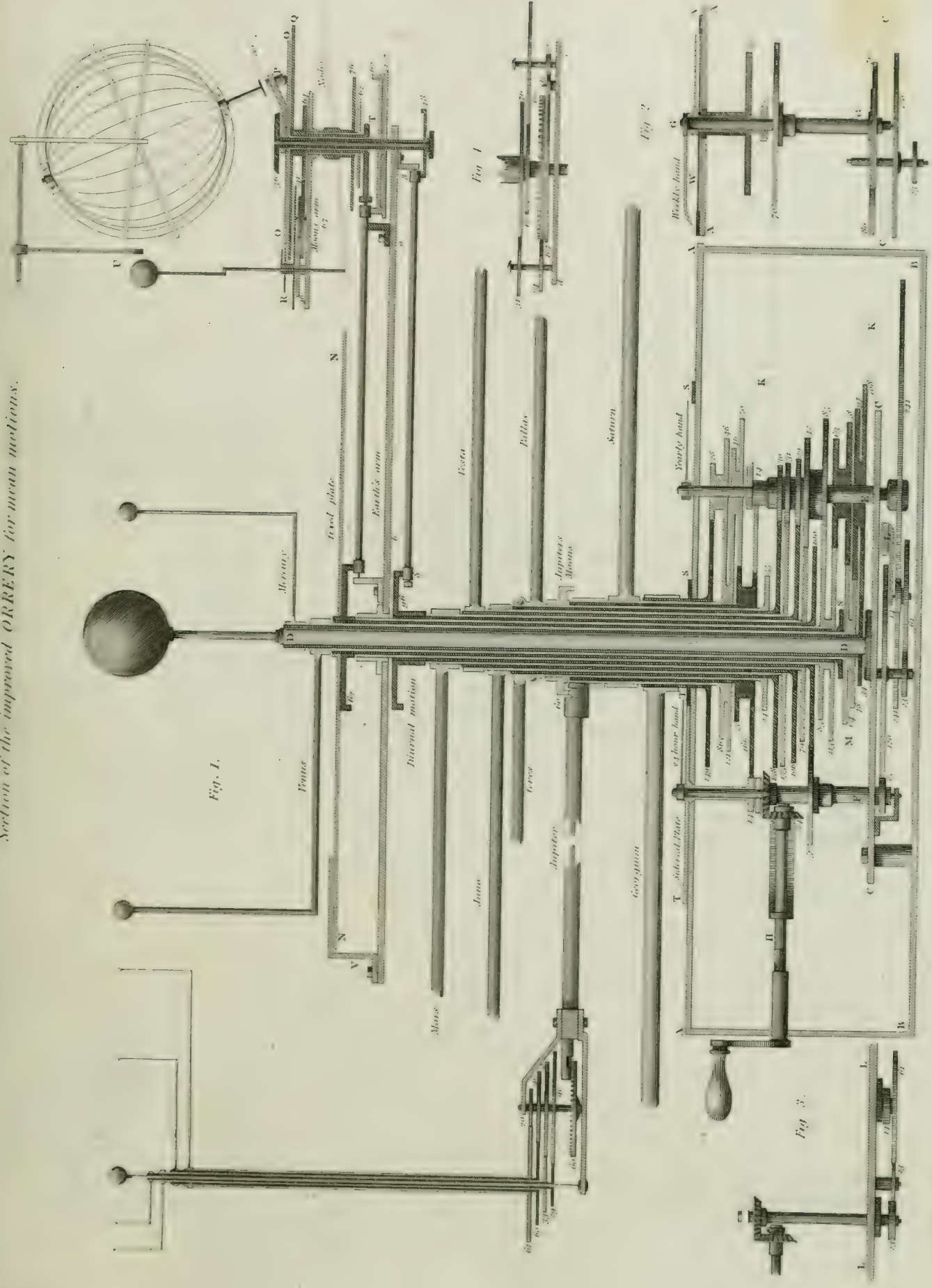

Fig. 1.

Fig. 2.

Fig. 3.

J. Ivory del. et.

R. Fidler fecit.

Published as the Act directs, 1855, by Longman, Hurst, Ross, Orme & Brown, Paternoster Row.

W. Woodcut.

Prospective view of the improved ORRERY for mean motions.

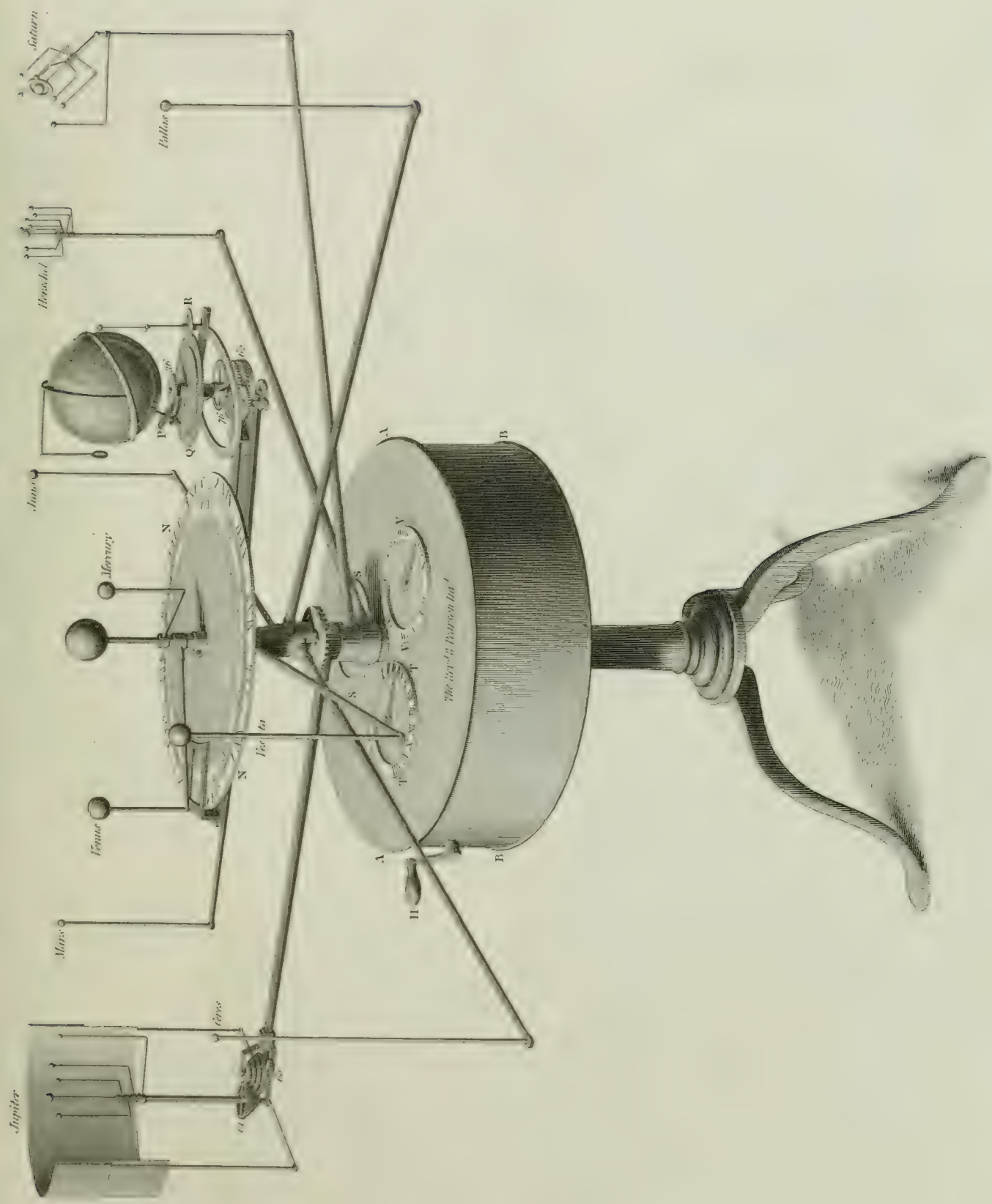

Published as the Act directs, 1819, by Longman, Hurst, Rees, Orme & Brown, Paternoster Row.

J. Cary, Sculptor.

Dials graduated for shewing
different planetary Phenomena

[see Orrery]

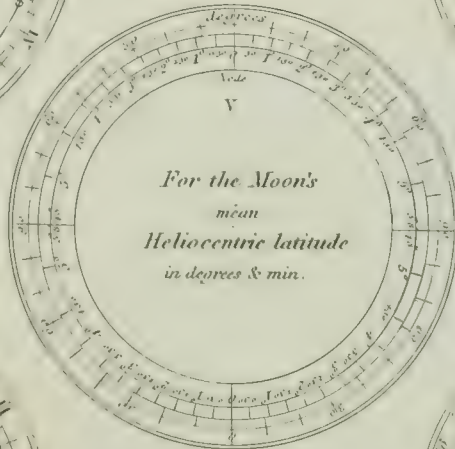
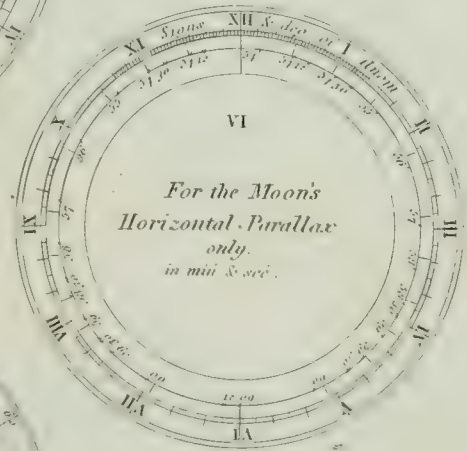
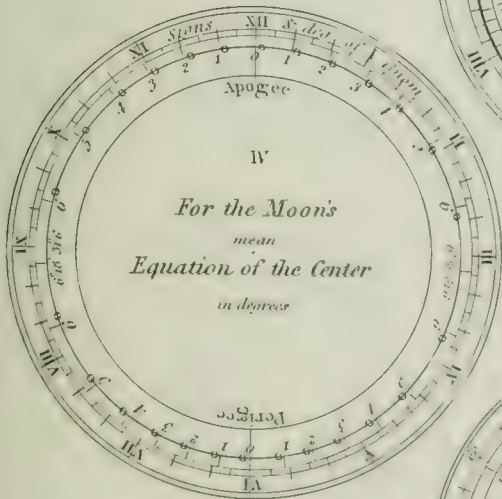
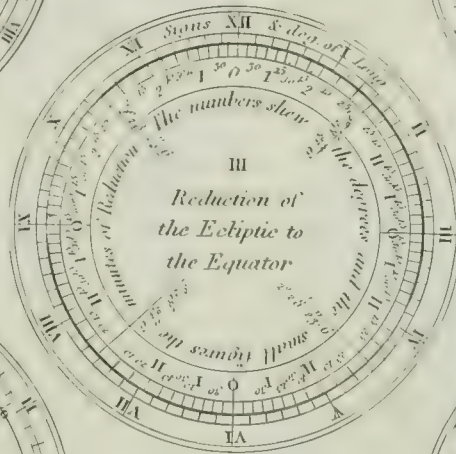
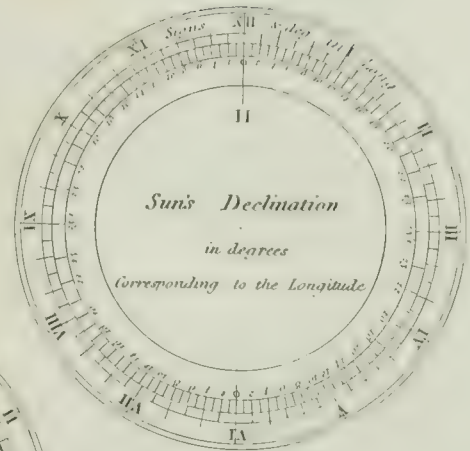

PLANETARIUM

of the Royal Institution by M. Pearson.

Common PLANETARIUM.

Fig. 1.

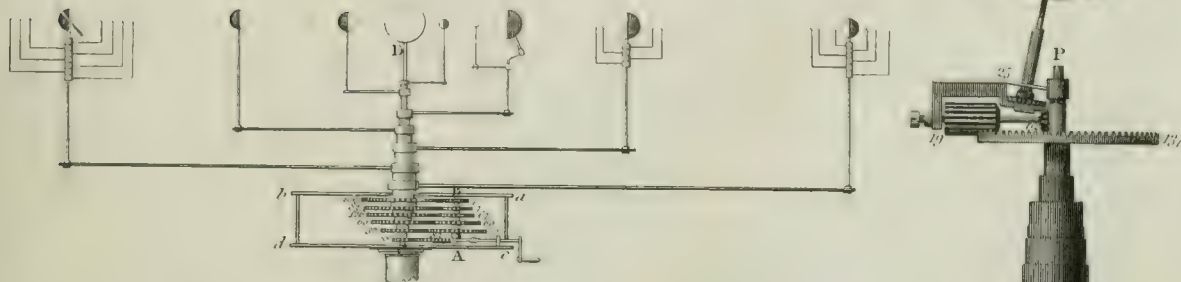

Fig. 1.

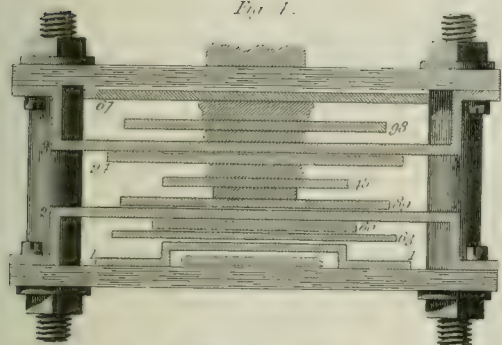

Fig. 3.

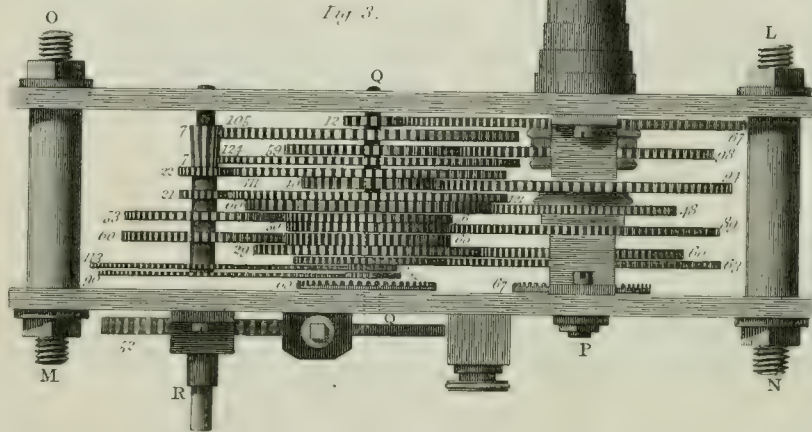
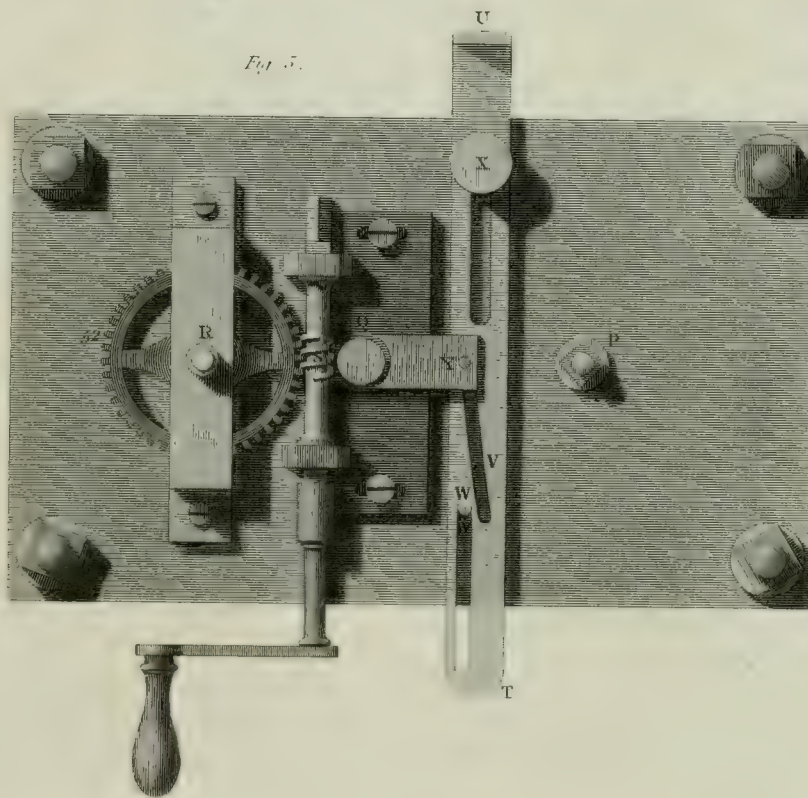

Fig. 2.



Fig. 5.



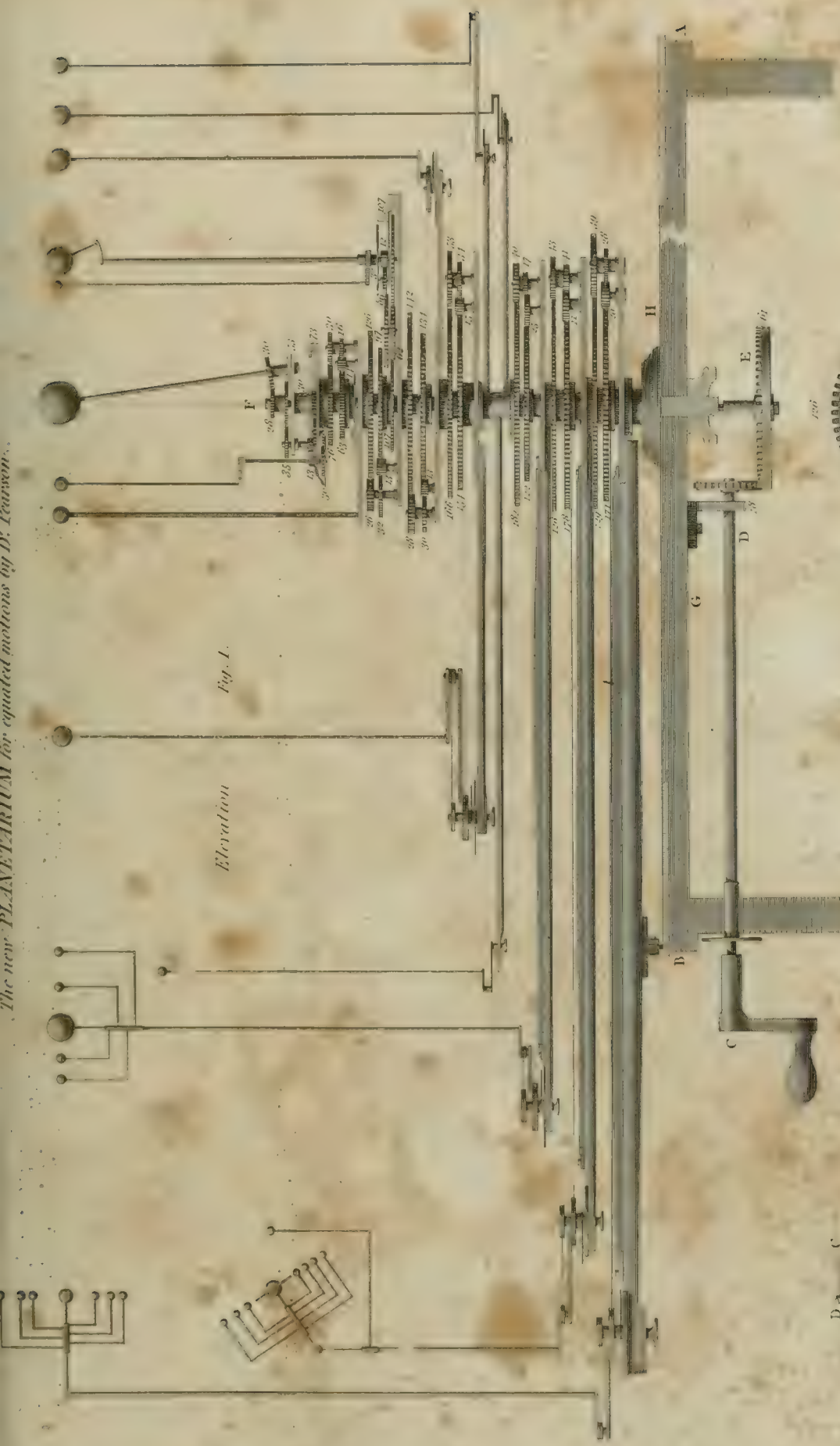

Fig. 1. Elevation

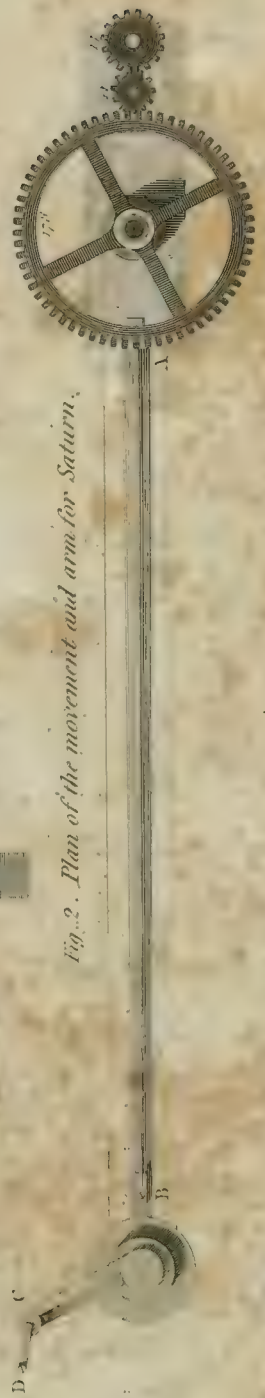

Fig. 2. Plan of the movement and arm for Saturn.



SATELLITE MACHINES.

Fig. 3.



Configuration of Satellites. Ap. 1. 1855. at 10^h.

Fig. 4.

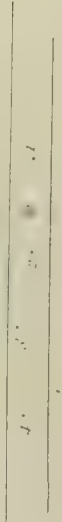

SATELLITE Machine by Roemer.

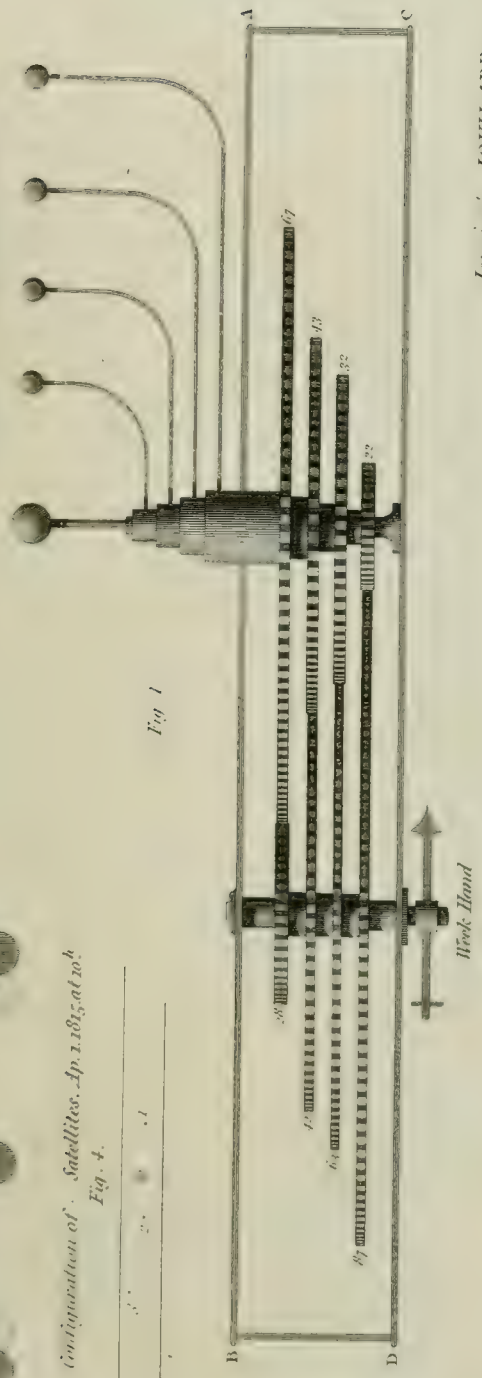
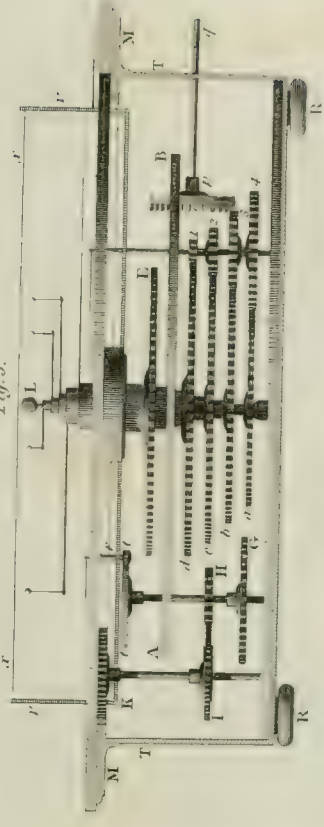

Fig. 1

Jouvier's JOTTLABE.

Fig. 5.



SATELLITAN by The Rev. d Wm Pearson.

Fig. 2.

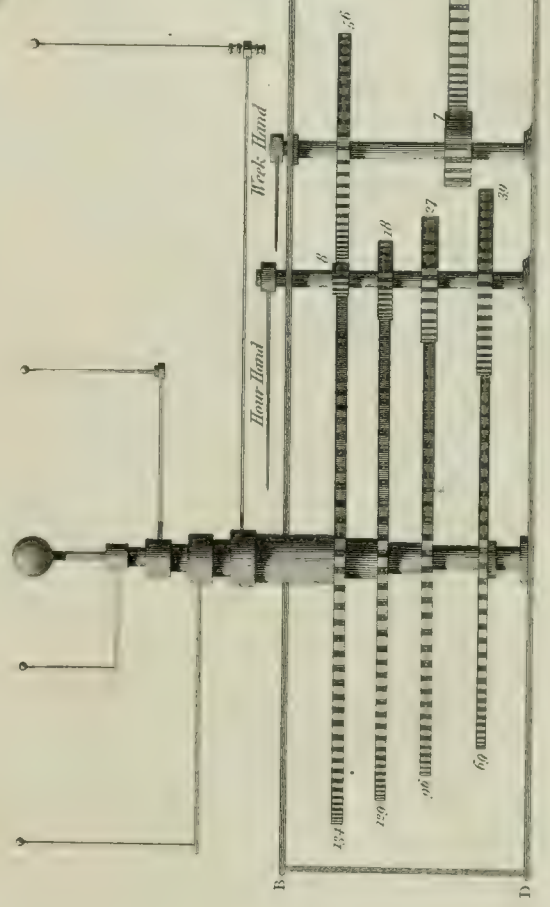

Month Hand

Week Hand

Hour Hand

Rev. W. Pearson's
 large Machine
 for Jupiter's Satellites

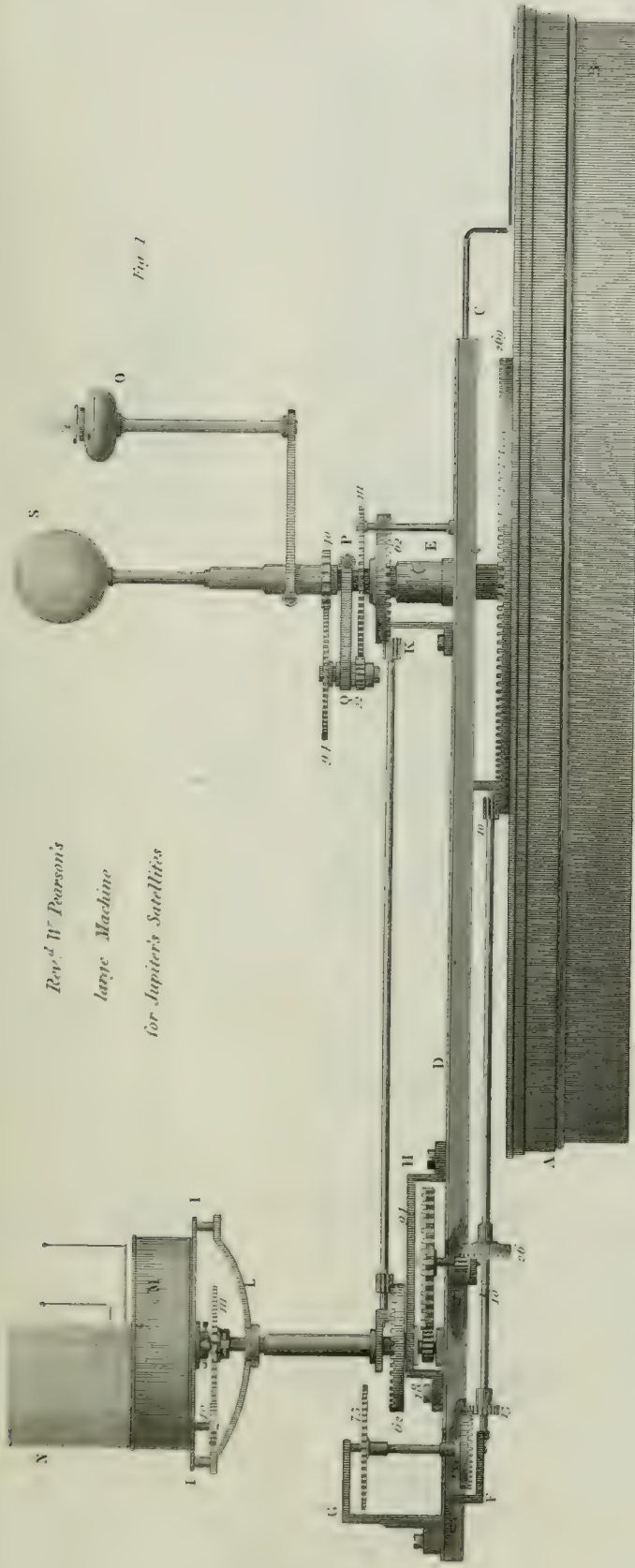

Fig. 1

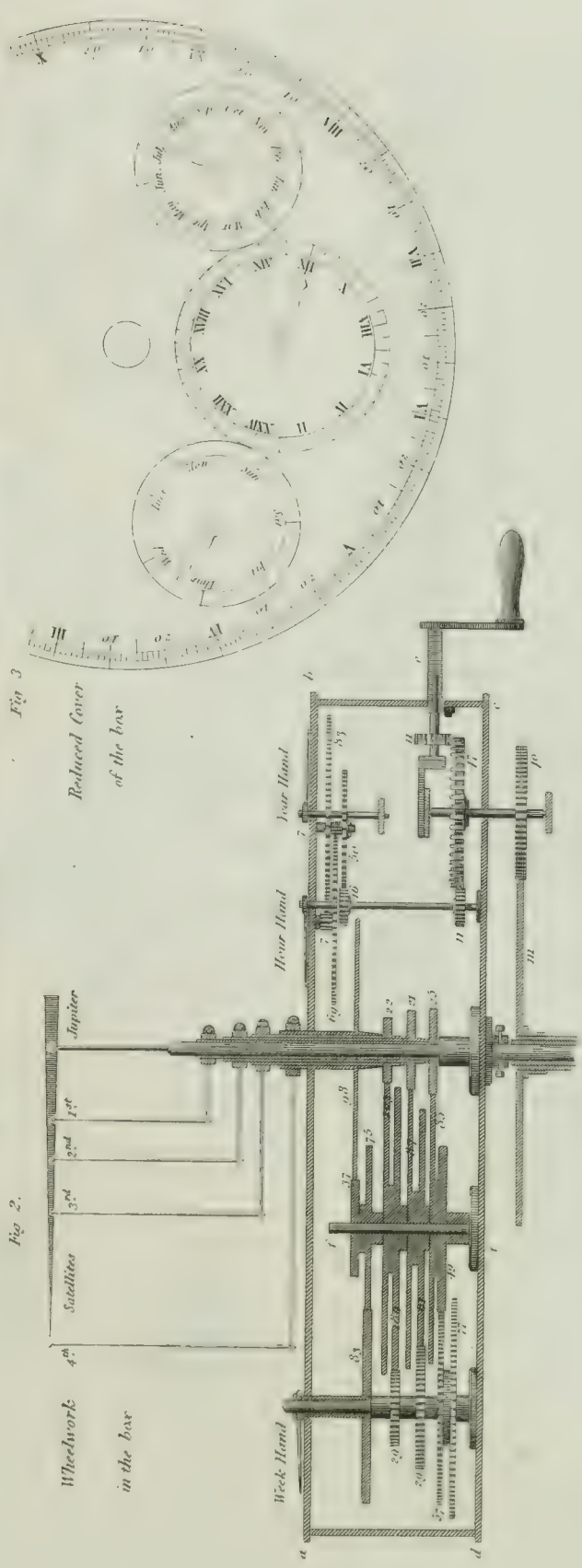

Fig. 3

Fig. 2

M. Bramah's Planing Machine.

Fig. 7.



Fig. 6.

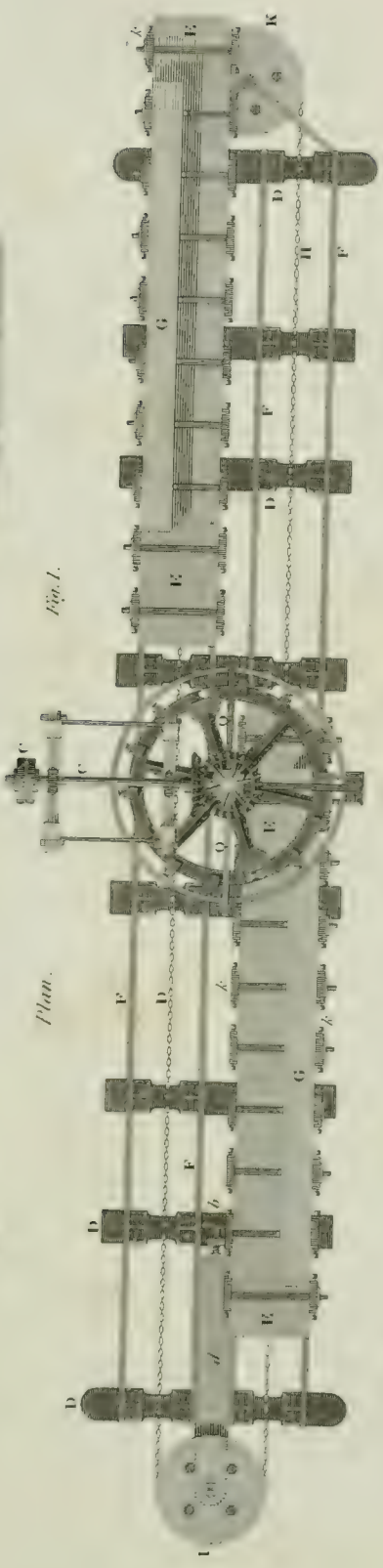

Fig. 1.

Fig. 4.

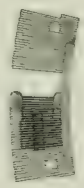
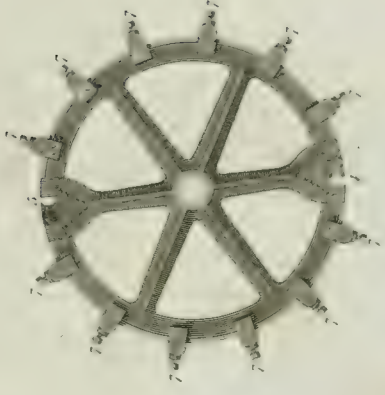

Fig. 3.



Elevation.

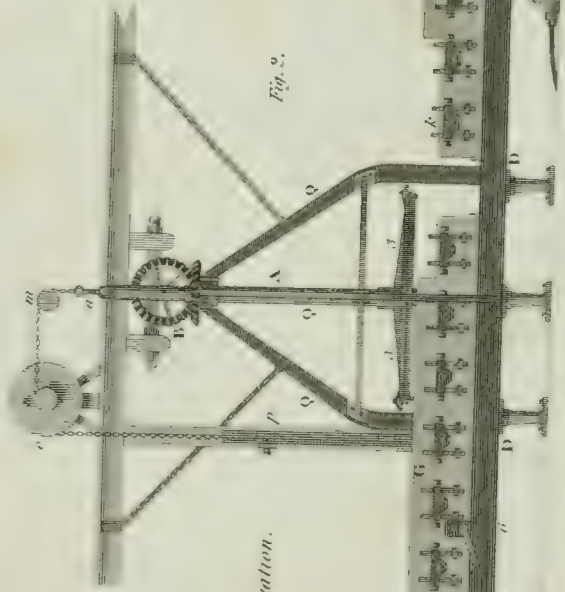
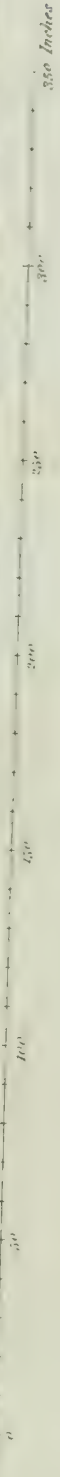
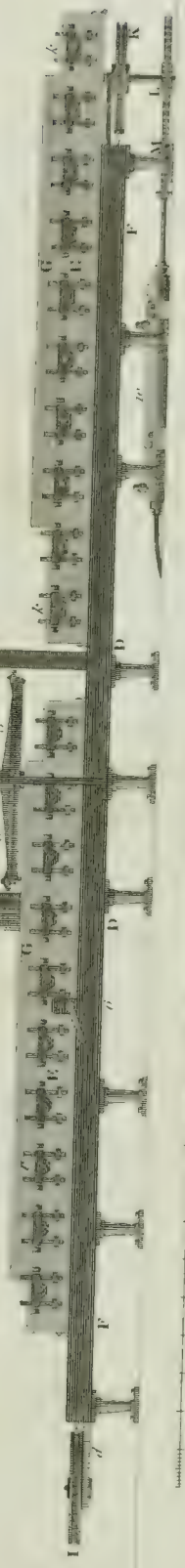
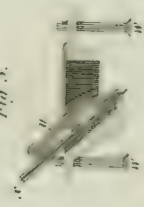

Fig. 2.

Fig. 5.



Cross Section,
Fig. 9.

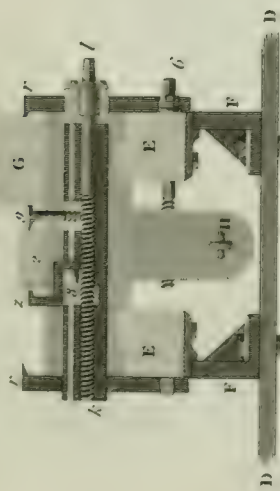
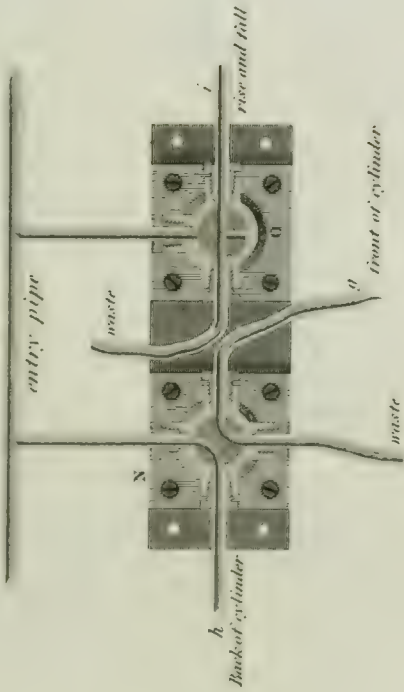
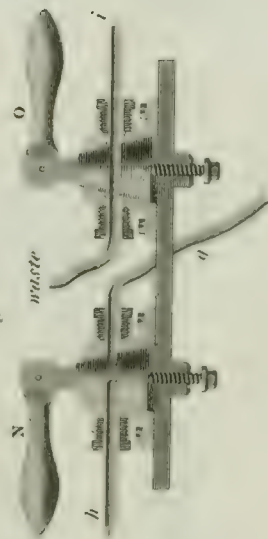

Fig. 10.



Cocks,
Fig. 11.



Cylinder
Fig. 10.

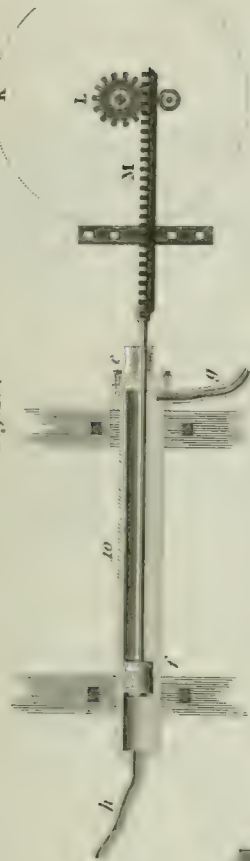
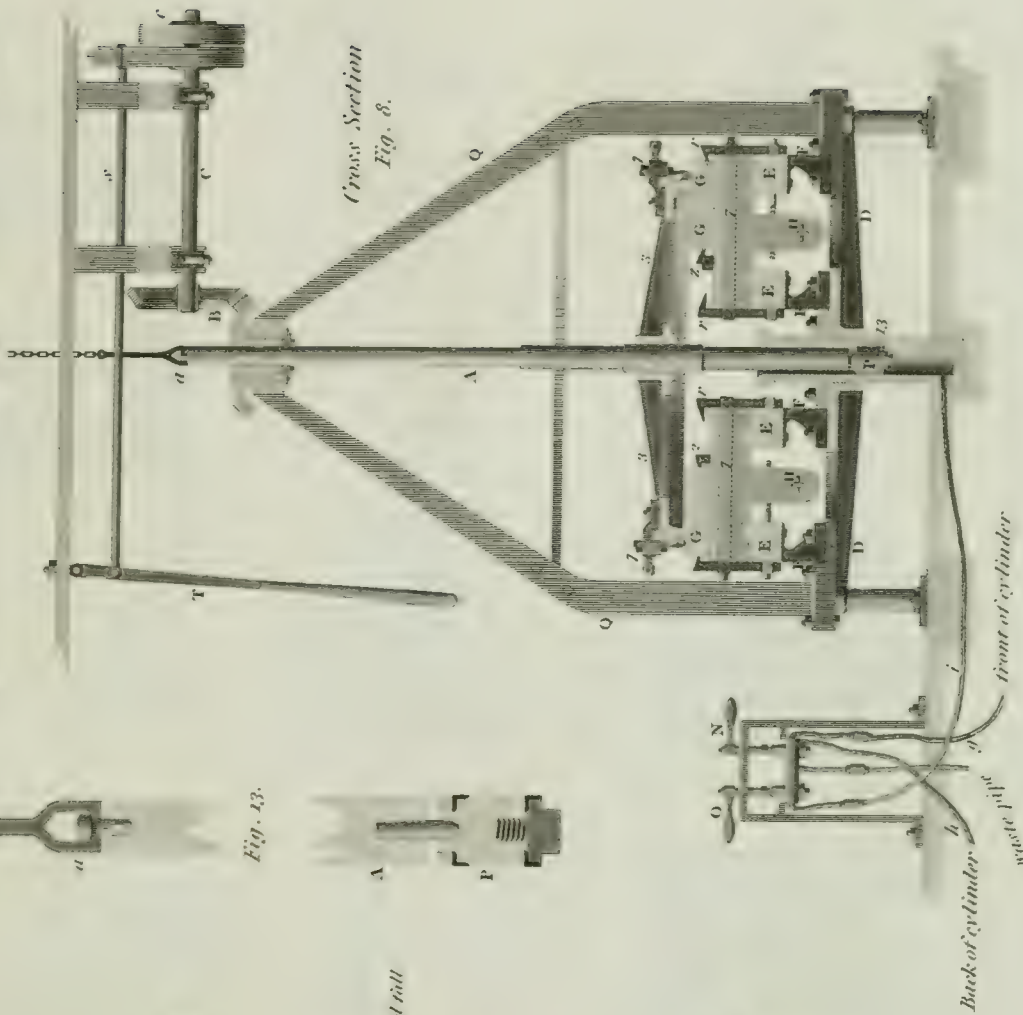

Fig. 13.



Cross Section
Fig. 8.



PLATED MANUFACTURE.

Bit Swage for mounting.

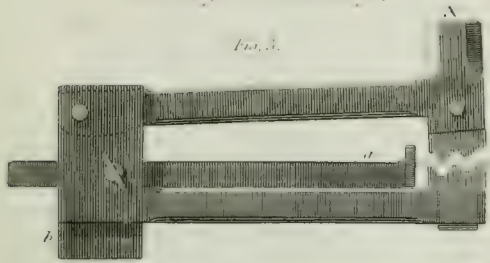

Fig. 3.

Common Swage.

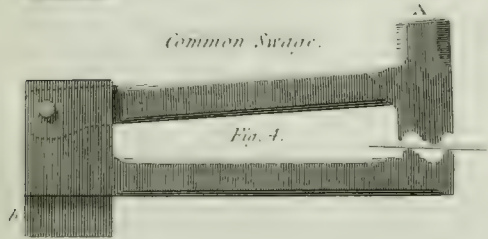

Fig. 4.

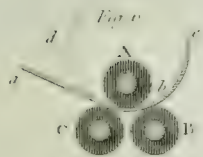

Fig. 6.

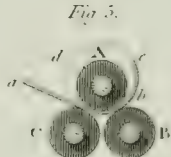

Fig. 5.

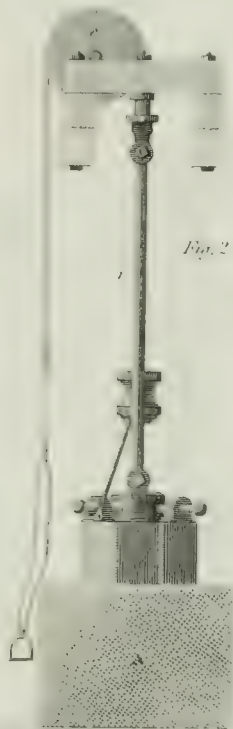

Fig. 2.

Die Stamp.

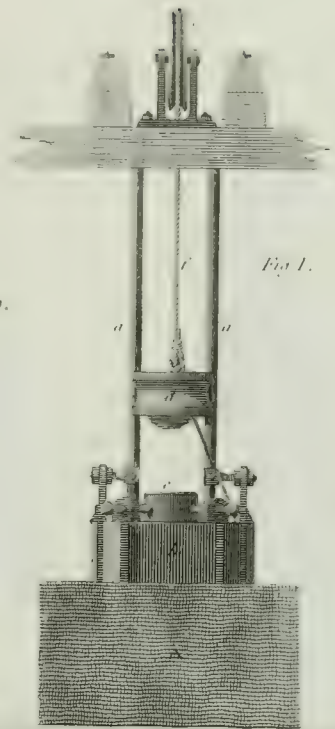

Fig. 1.

Embossing Punches.

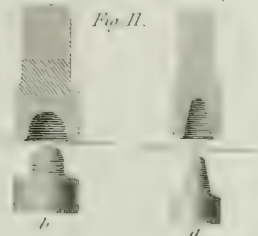

Fig. 11.

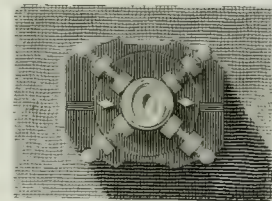
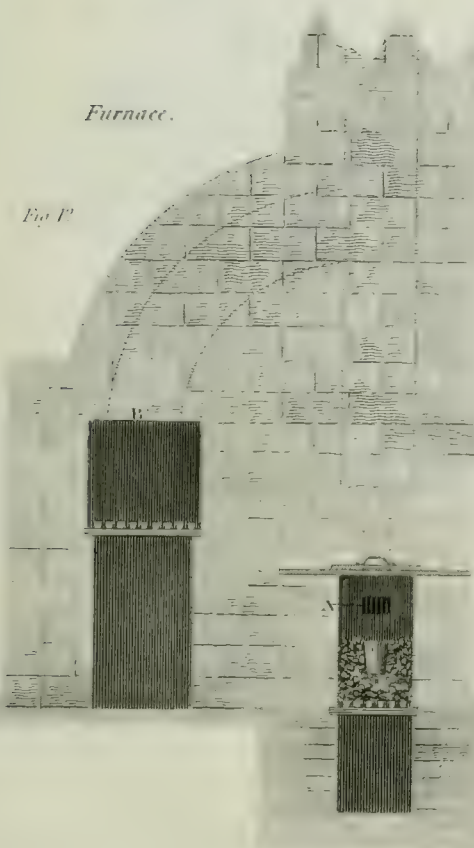

Fig. 7.

Furnace.

Fig. 12.



Grooved Rollers for beads &c.

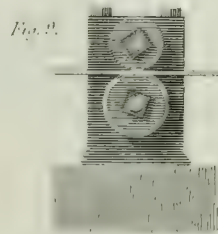

Fig. 9.

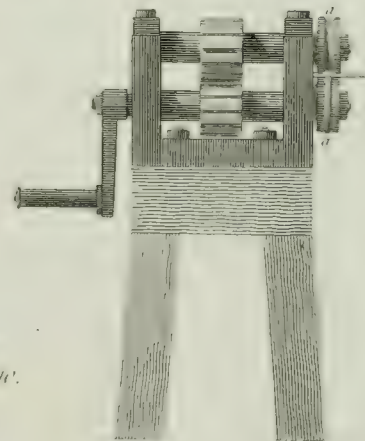

Fig. 8.



Fig. 10.

AEROSTATION

ECLIPSE

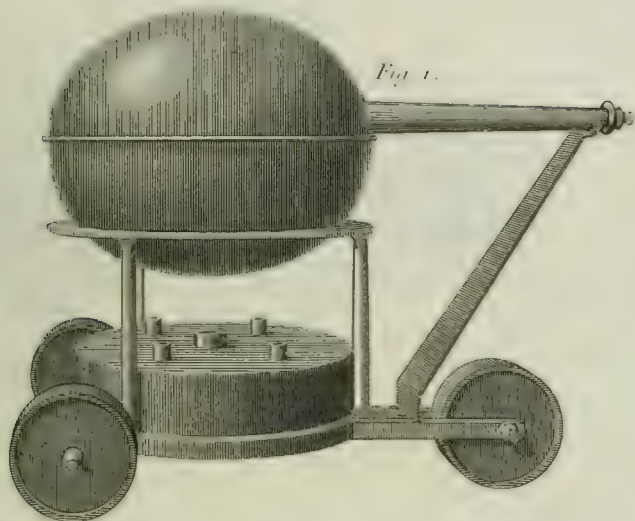

Fig. 2

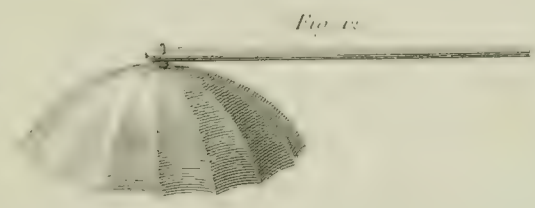
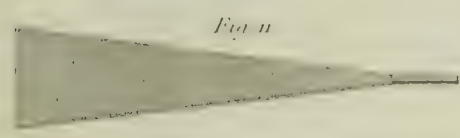
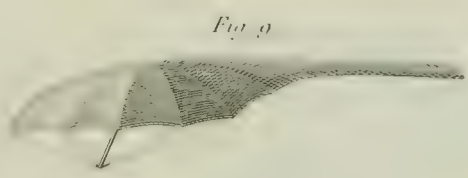
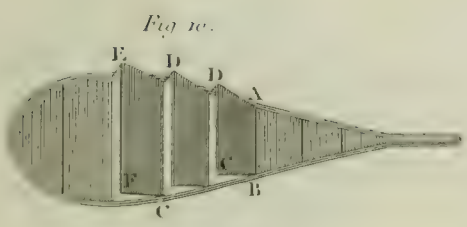
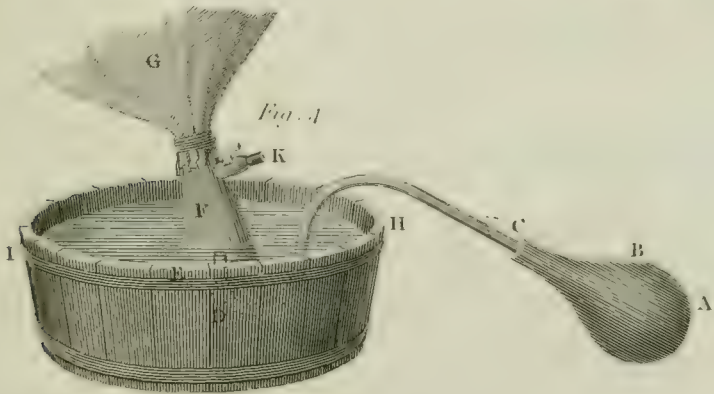
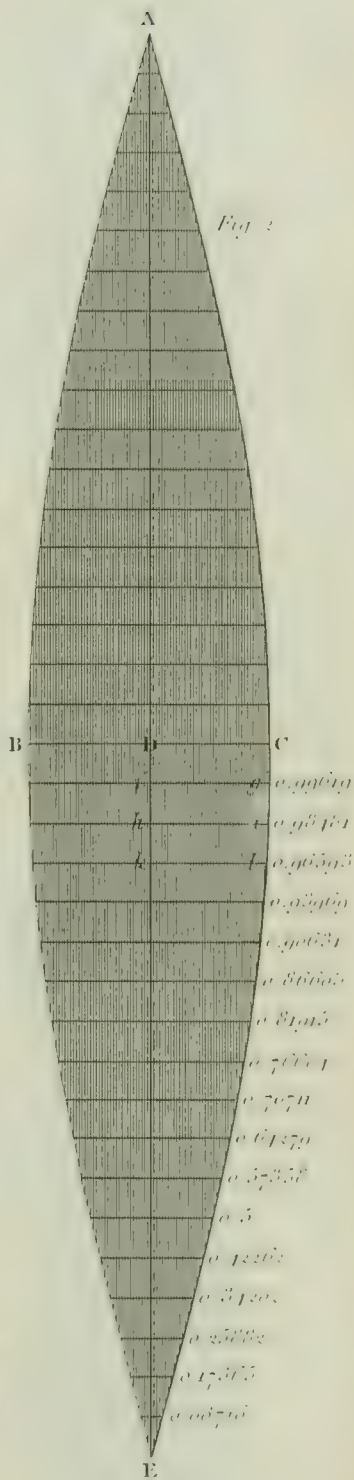
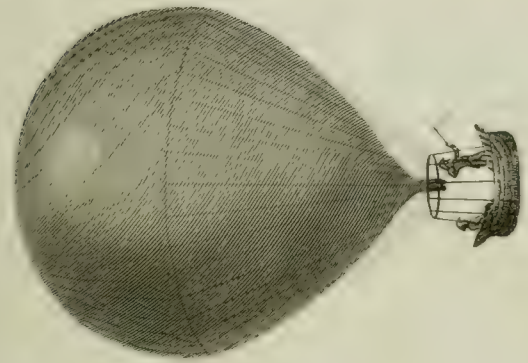

Fig. 8.



PNEUMATICS.

AEROSTATION.

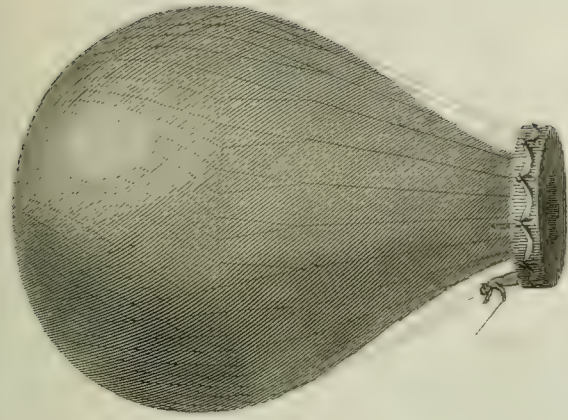

Fig. 6.

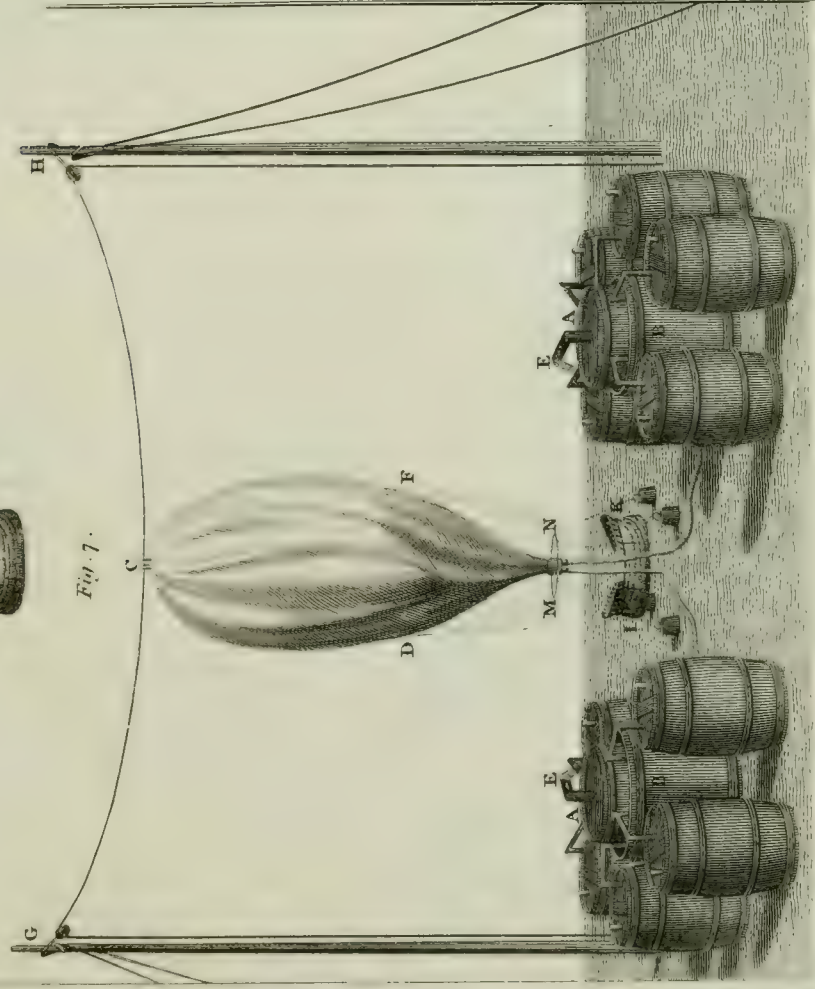
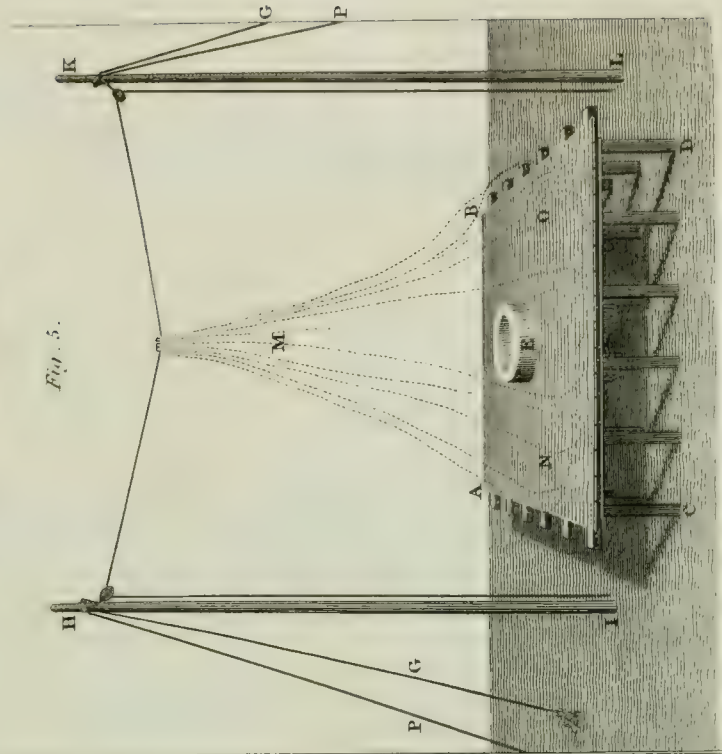

Fig. 7.

Fig. 5.



Published as the Act directed, Oct. 3, 1863, by Longman & Reed, Patentee & Rev.

Engraved by W. Wood, Lowry.

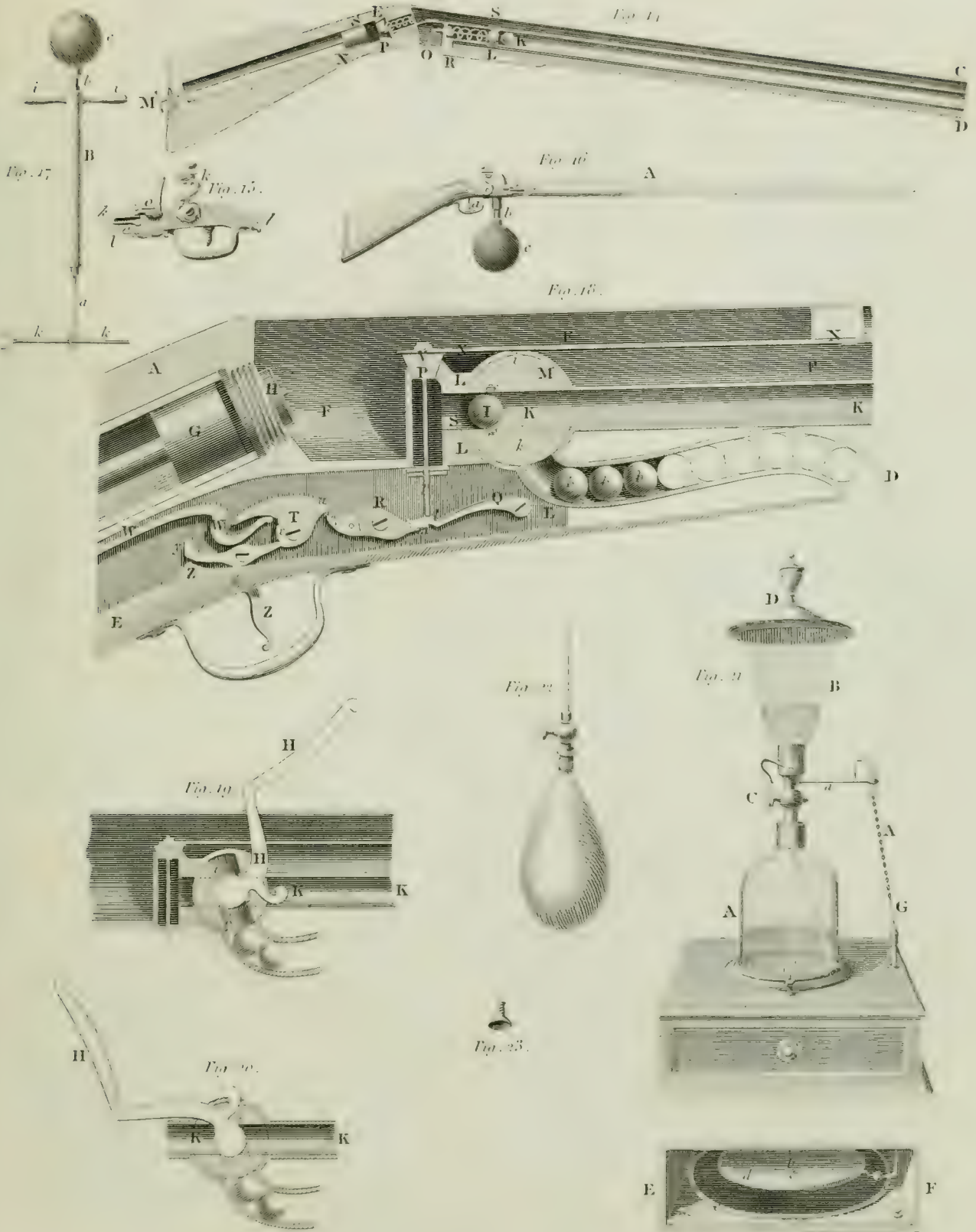

AIR-Pump and Experiments on AIR.

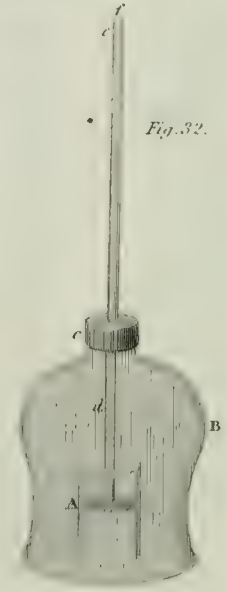
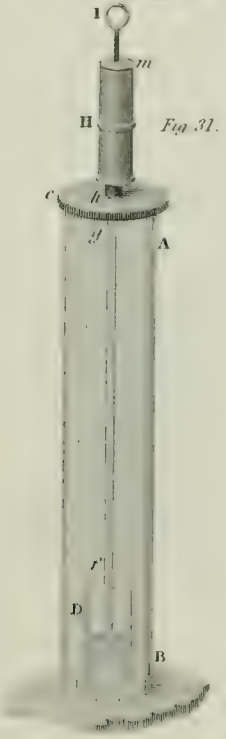
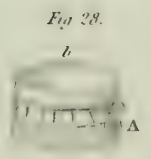
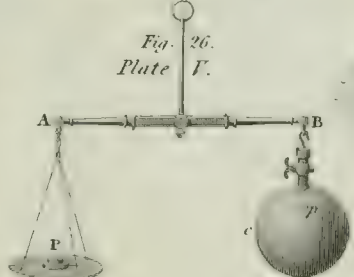
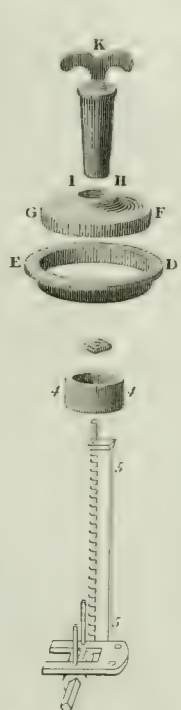
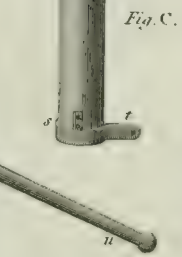
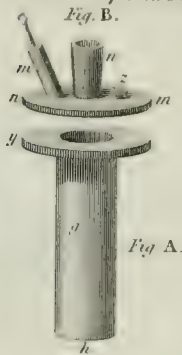
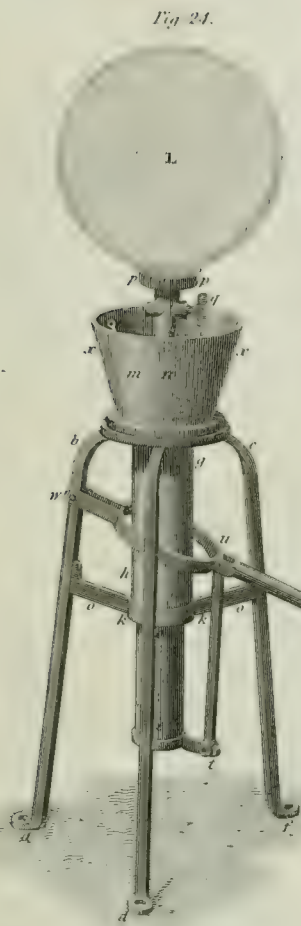

Fig. 35.

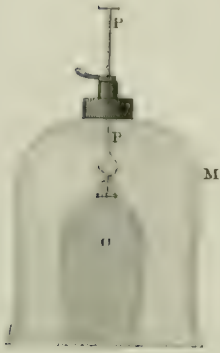

Fig. 36.



Fig. 37.

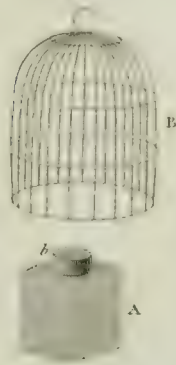

Fig. 38.

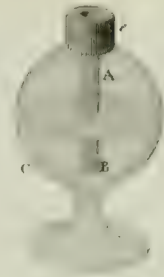

Fig. 39.

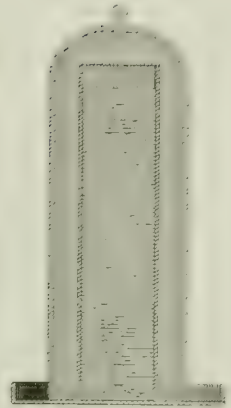

Fig. 33.

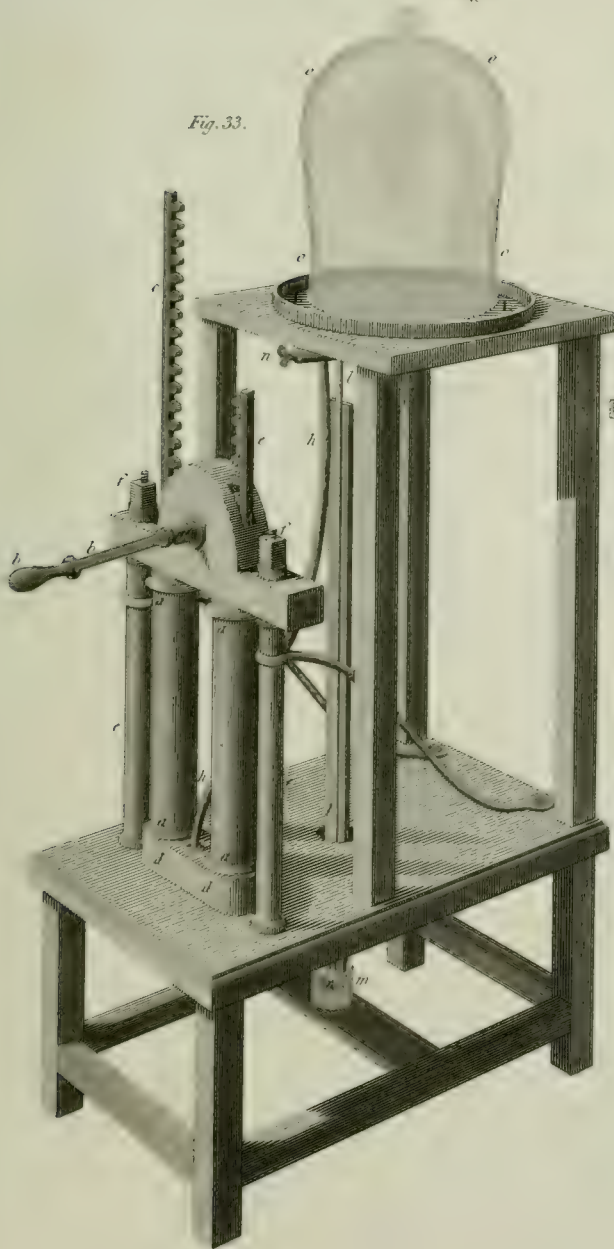

Fig. 40.

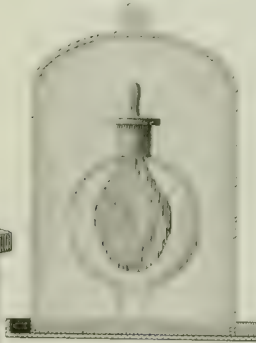

Fig. 42.

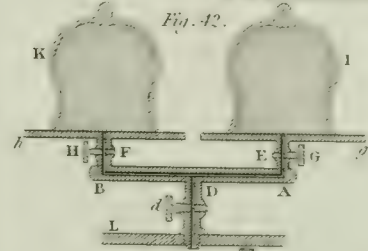

Fig. 43.

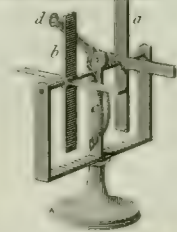

Fig. 41.

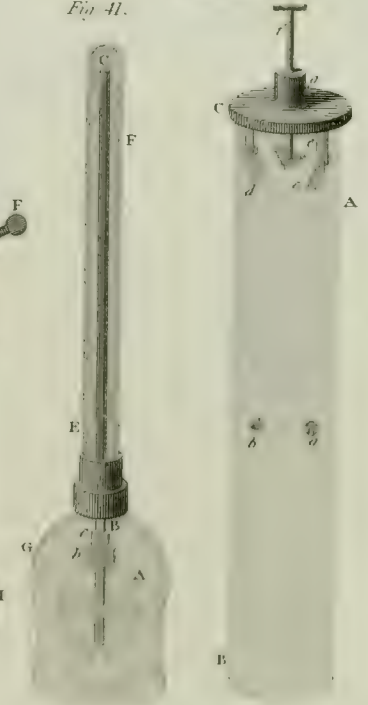

Fig. 44.

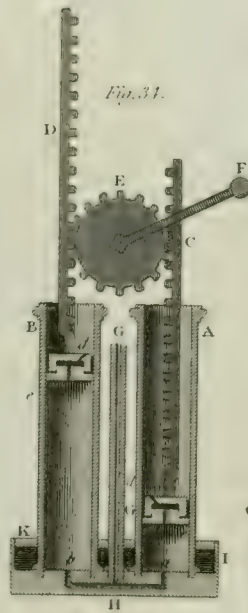

Fig. 31.

AIR PUMP.

Smeaton's

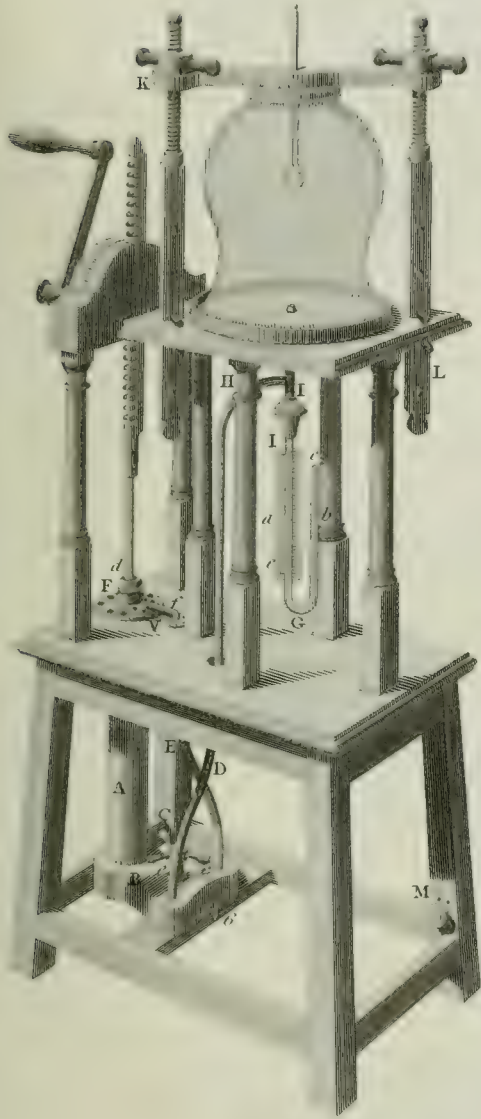

Fig. 45.

Nairne's

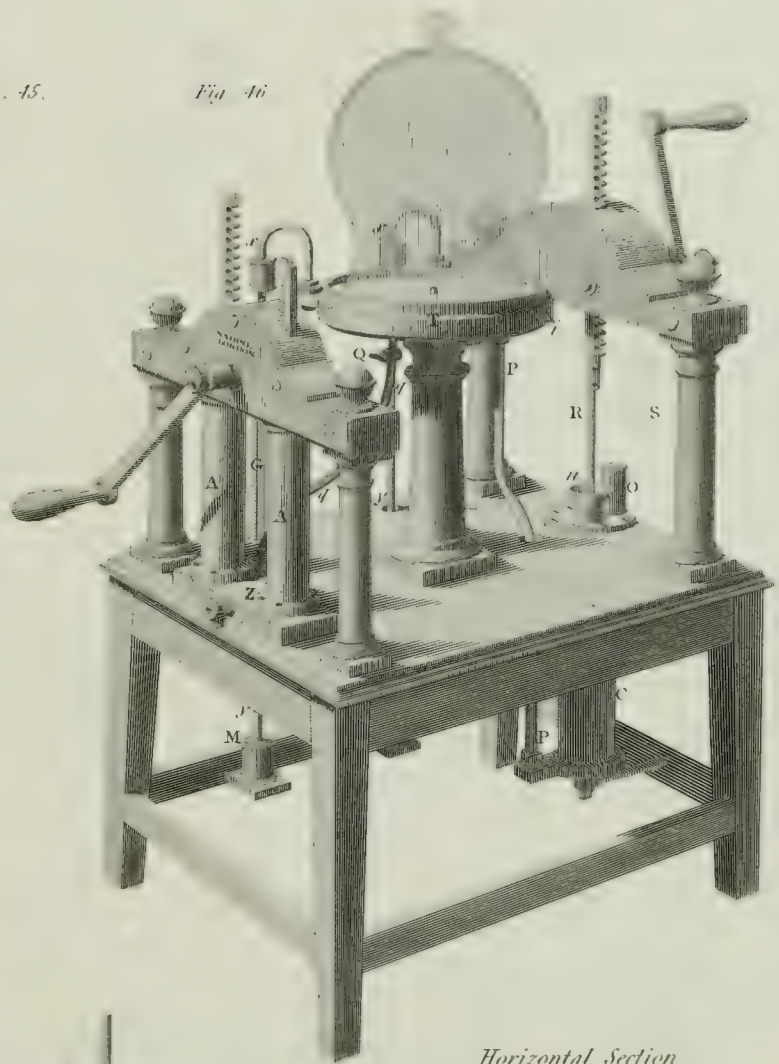

Fig. 46.

Horizontal Section

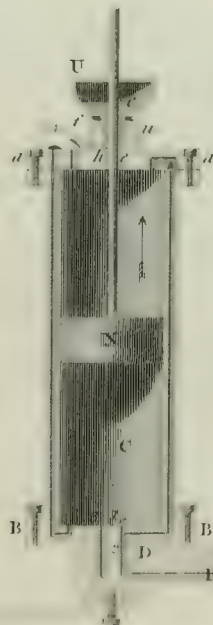

Fig. 47.

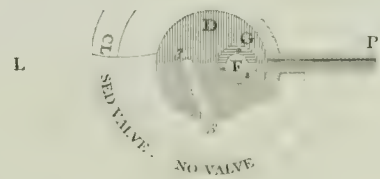

Fig. 48.

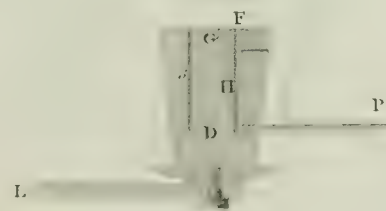

Fig. B.B.



AIR PUMP &c.

Fig. 48.

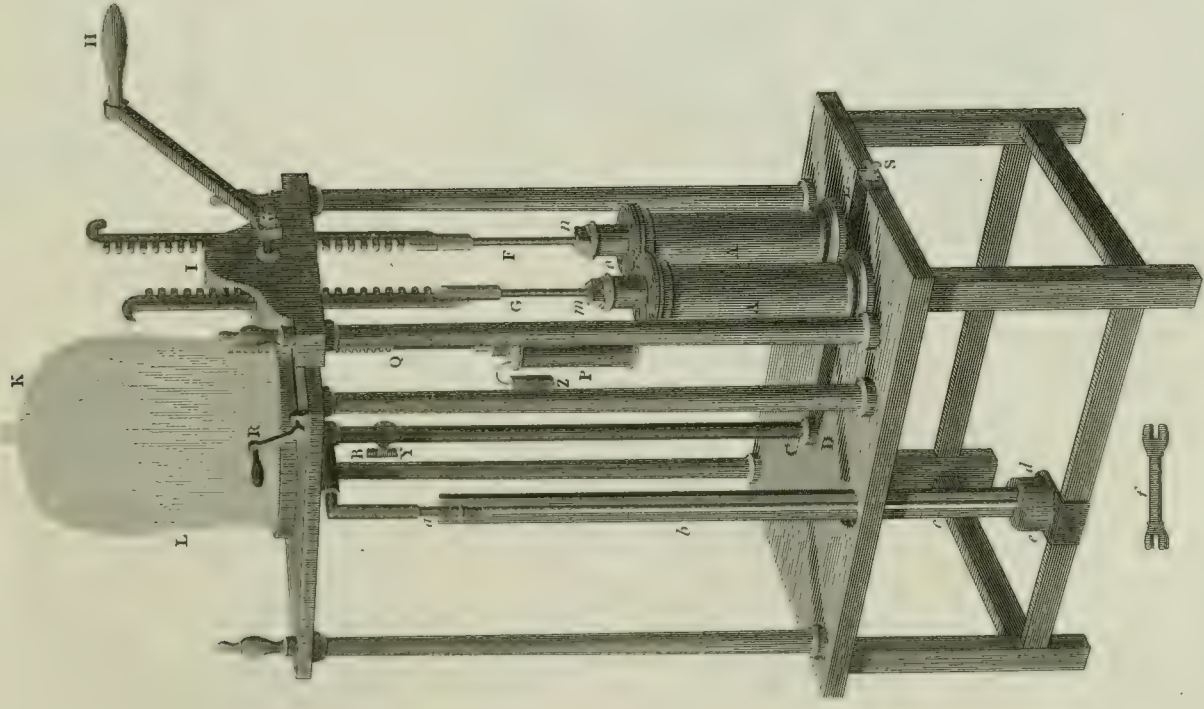

Fig. 55.

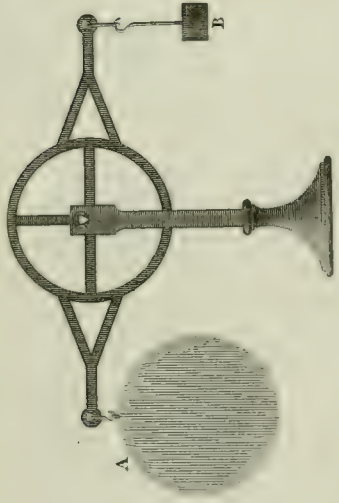

Fig. 54.

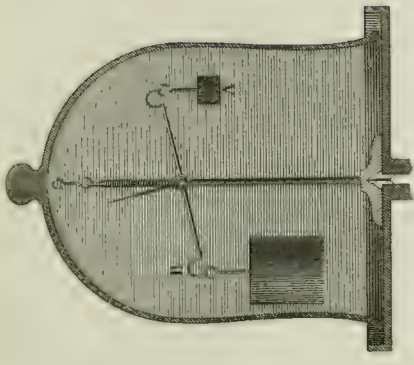

Fig. 49.

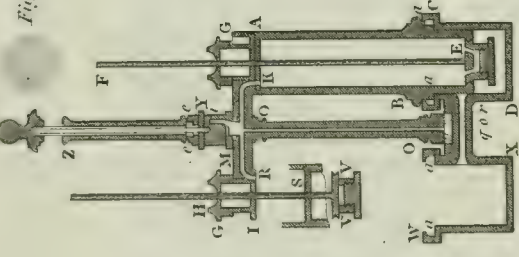

Fig. 50.

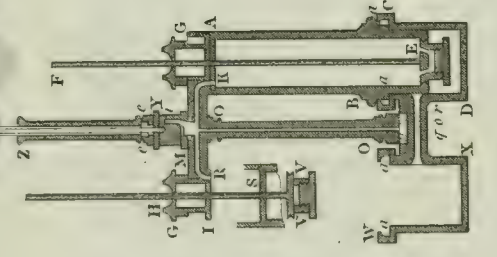

Fig. 53.

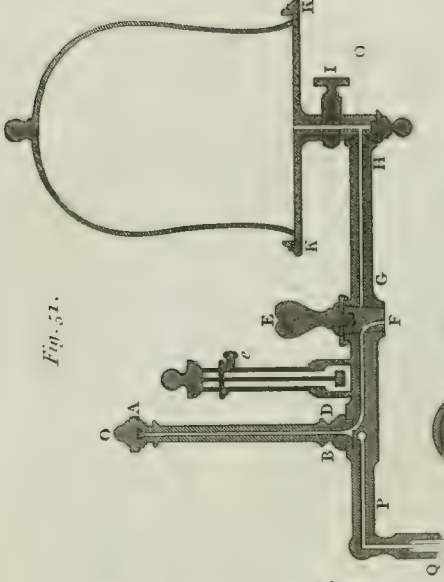

Fig. 52.

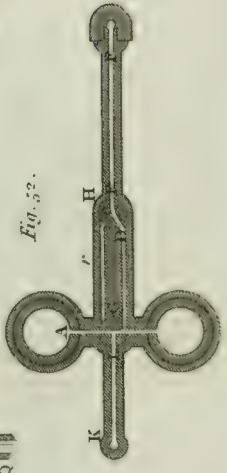

Fig. 53.



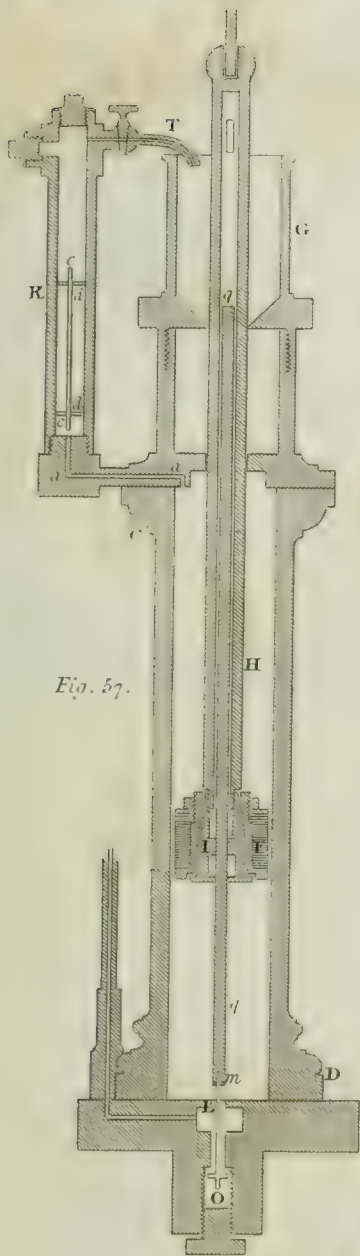

Fig. 57.

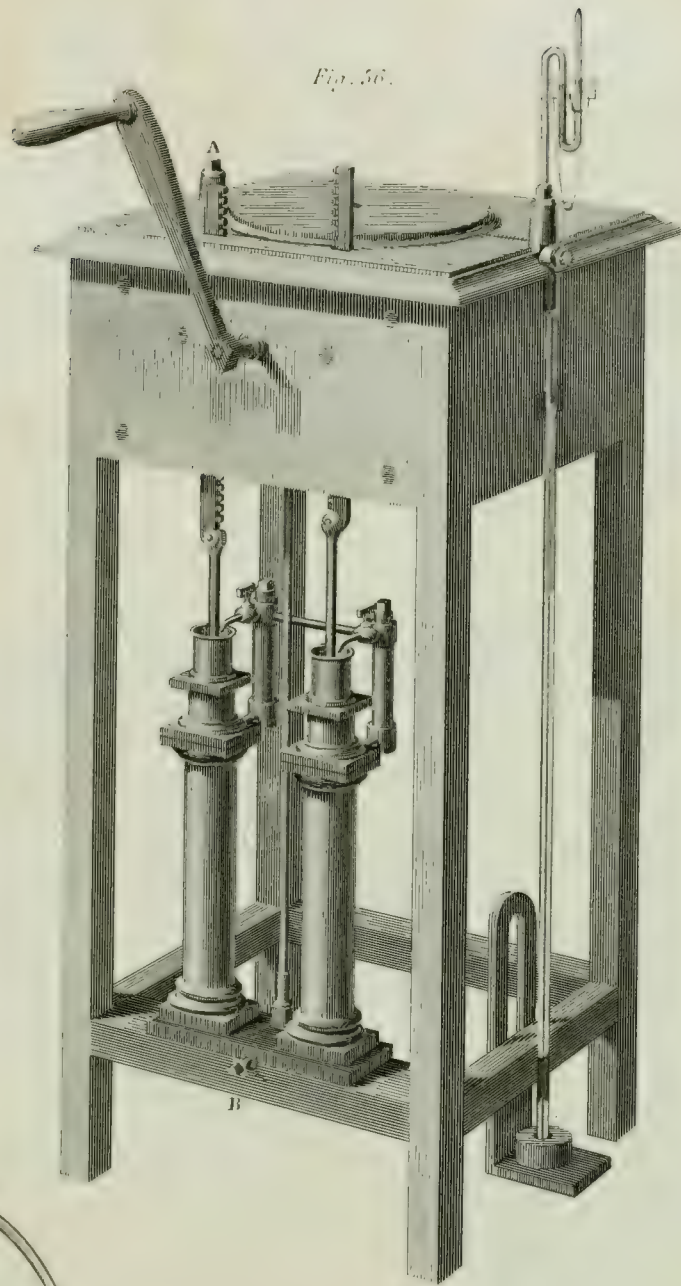
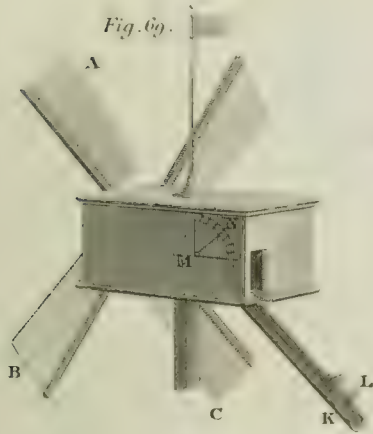

Fig. 56.

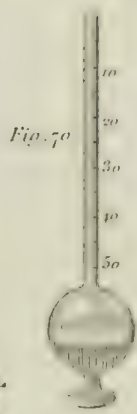

Fig. 68.

ANEMOMETER.



BAROMETER.



ATMOSPHERE.

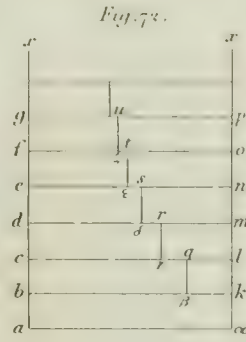

BACCHUS.



CUTHBERTSON'S AIR PUMP.

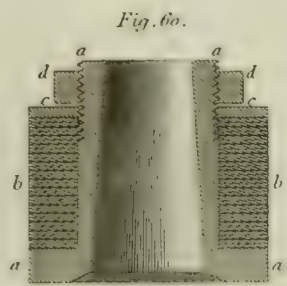
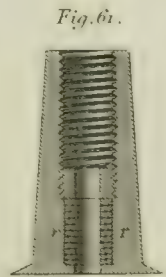
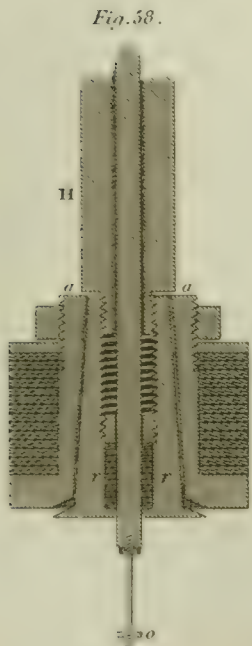
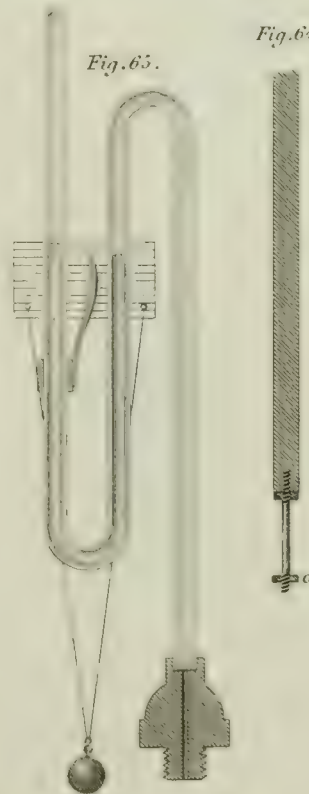
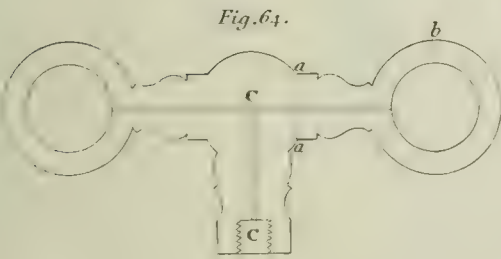
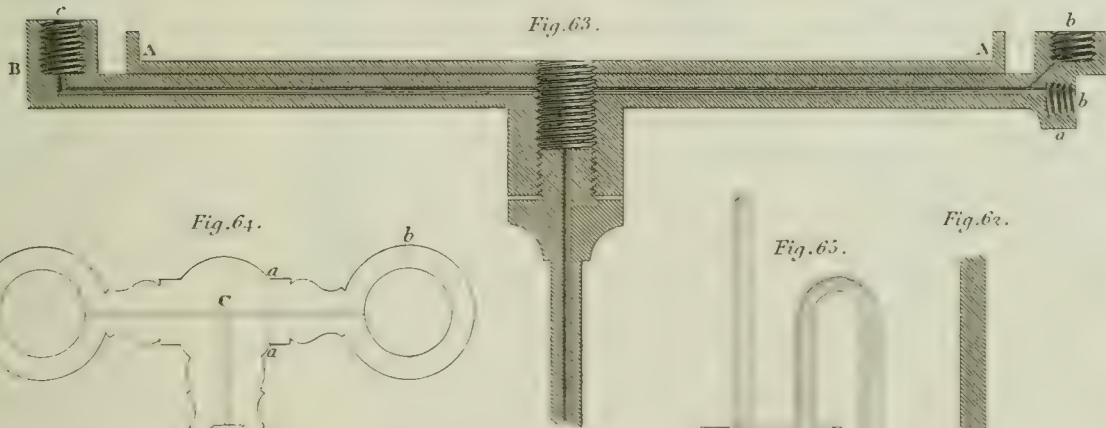

BAROMETER.

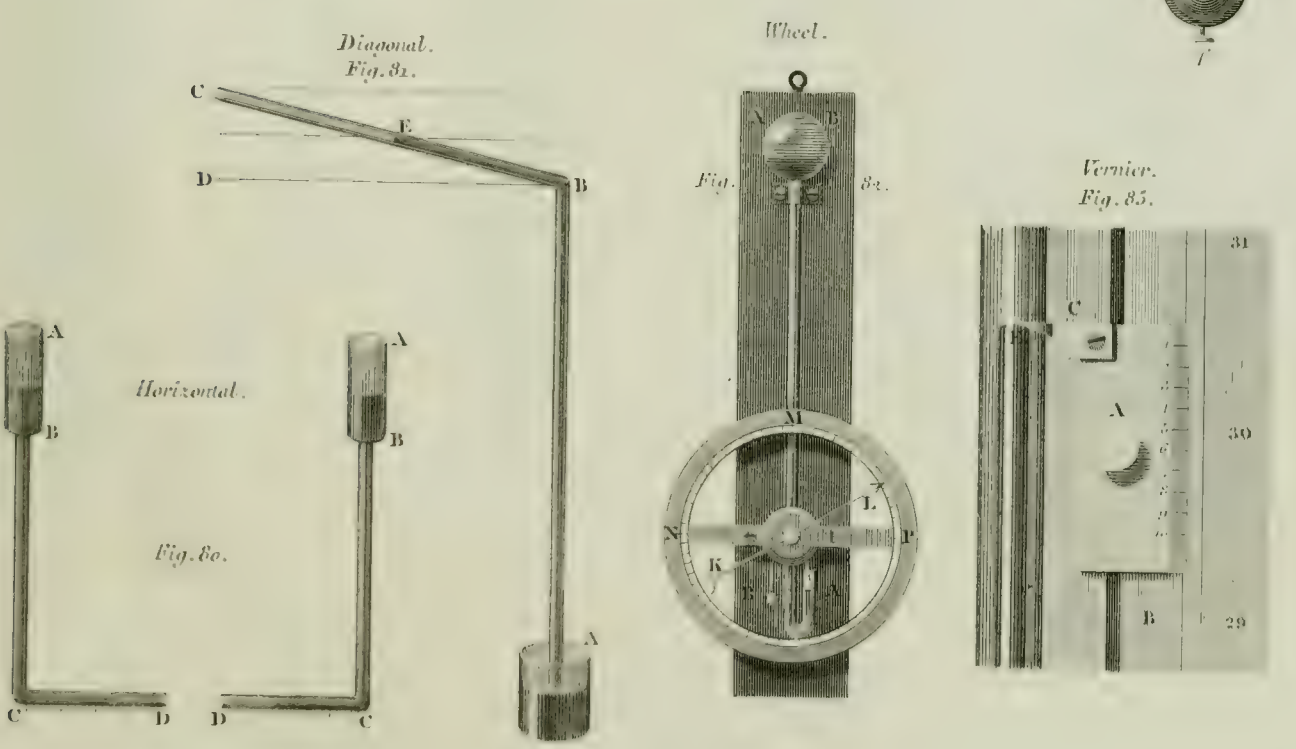
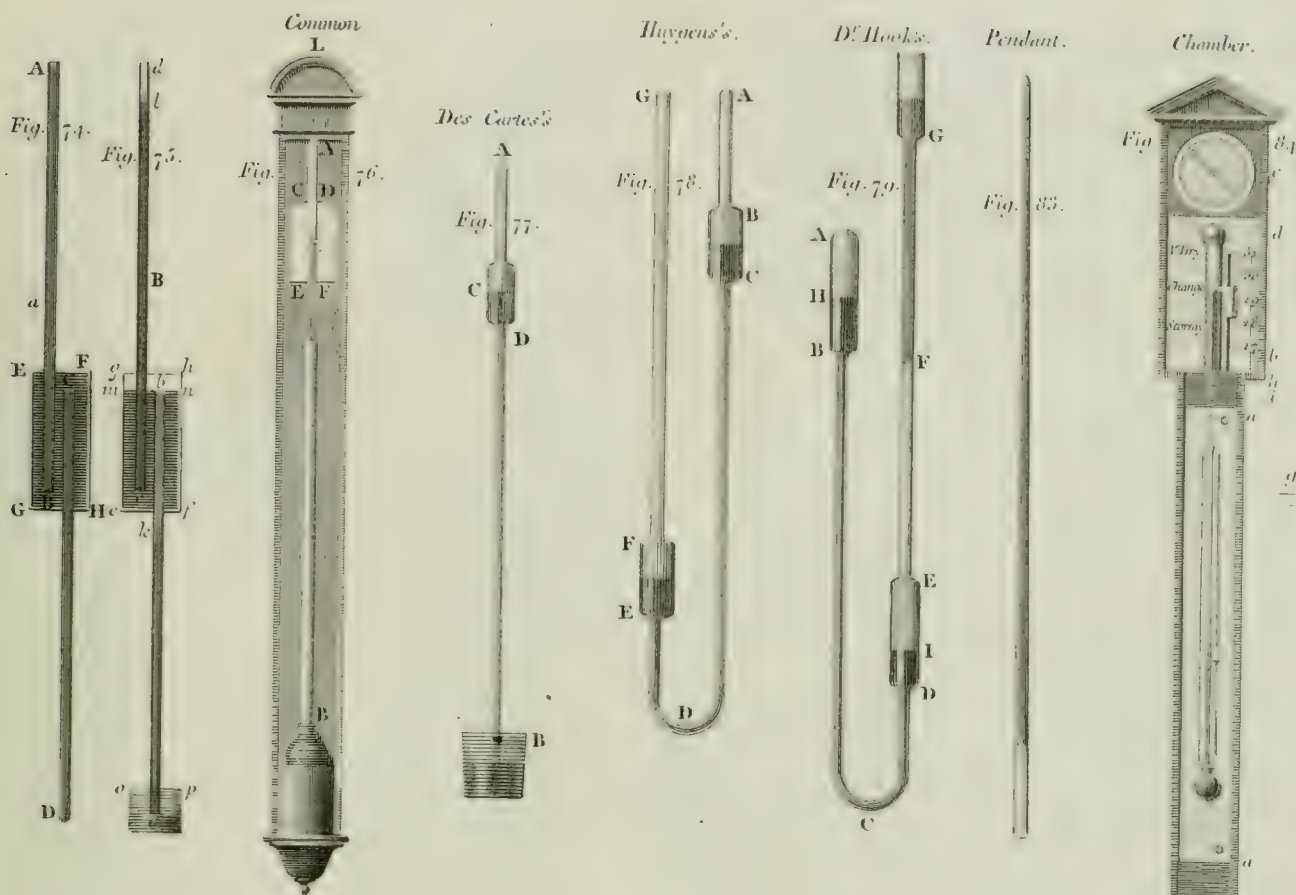

BAROMETERS.

Maria

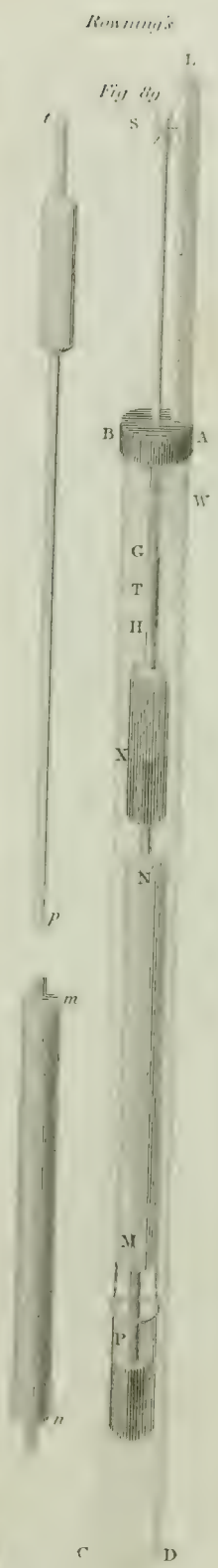
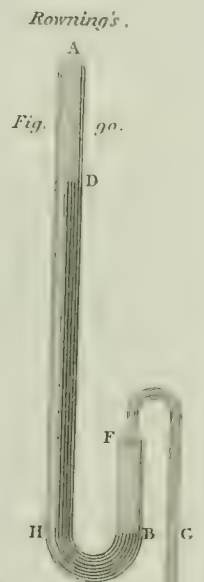
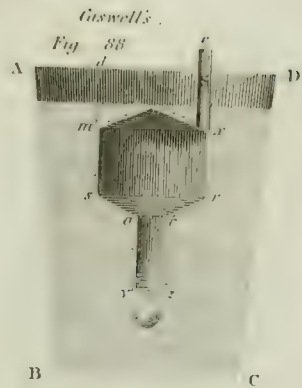
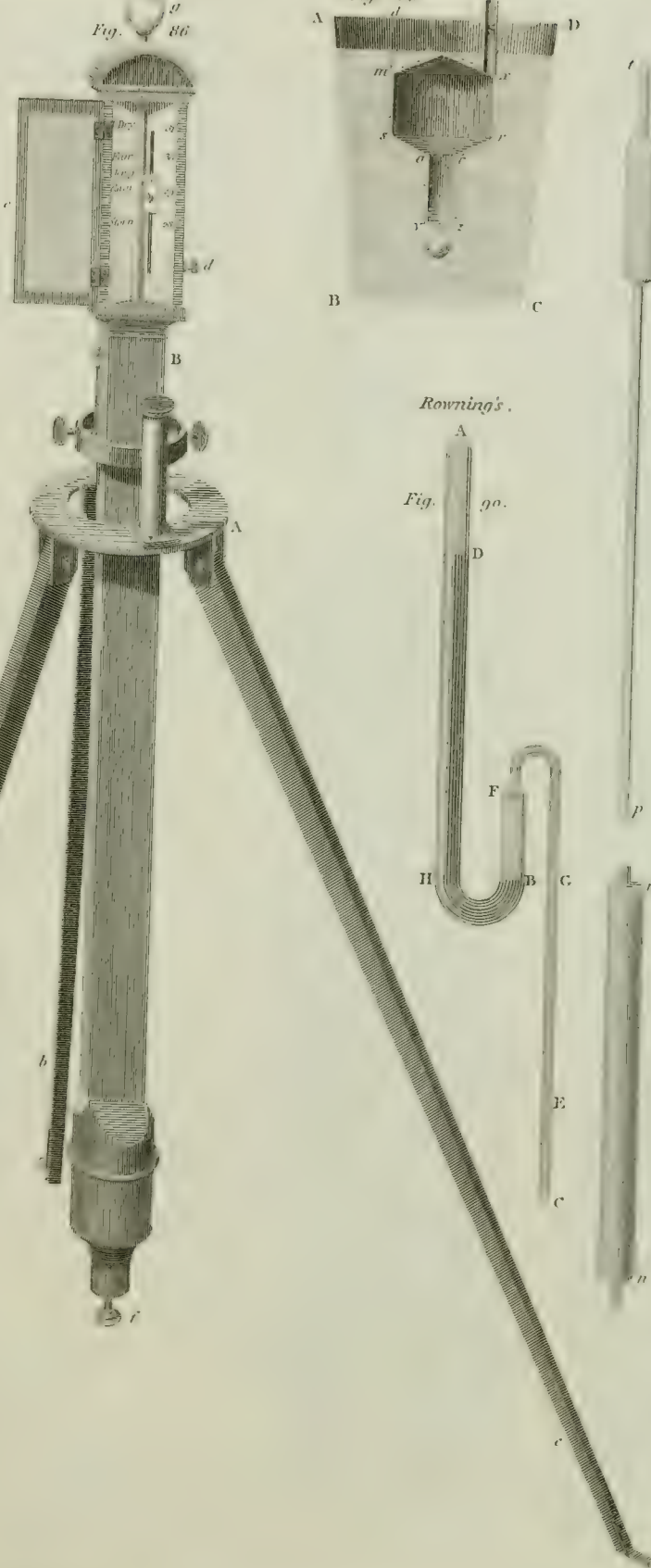
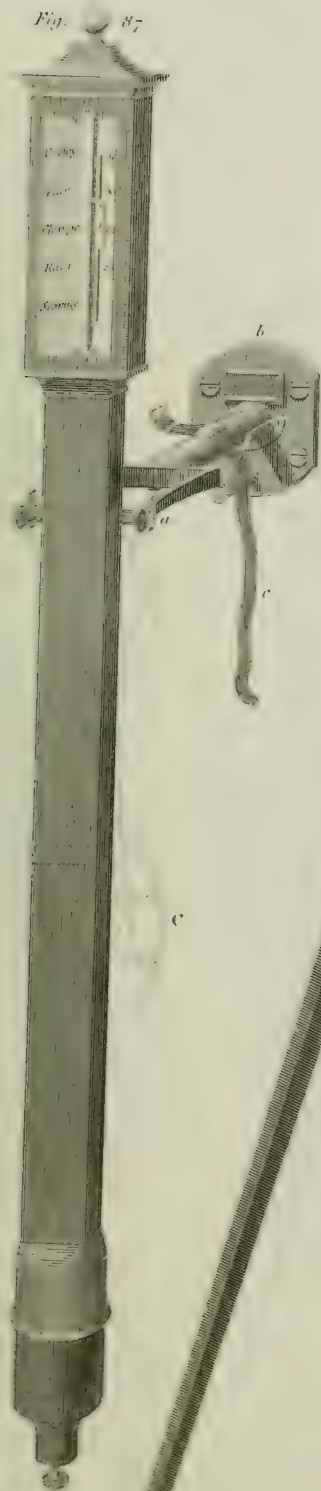

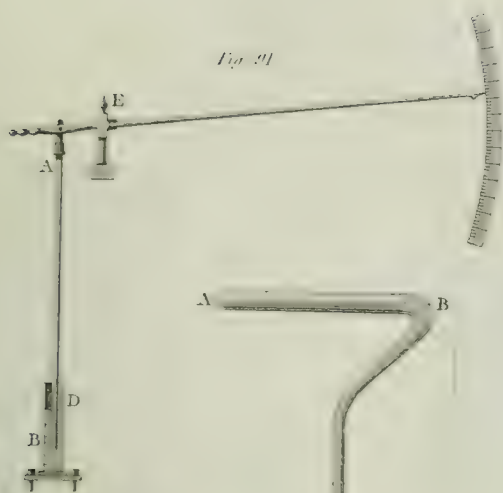

Fig. 91



Keith's.

Fig. 92.

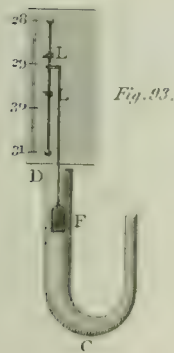

Fig. 93.

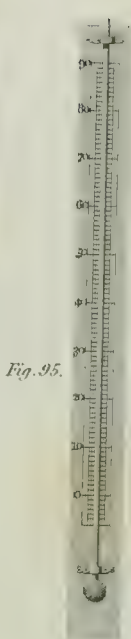
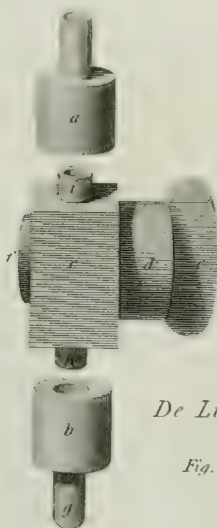

Fig. 95.



De Luc's.

Fig. 94.

Hamilton's.

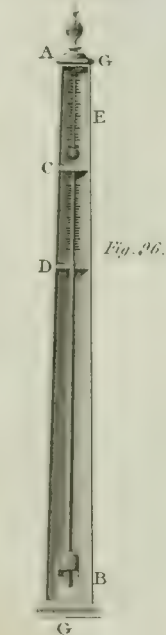

Fig. 96.

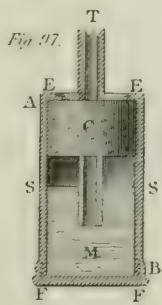

Fig. 97.

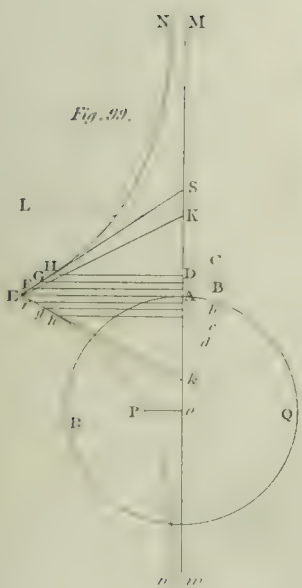

Fig. 99.

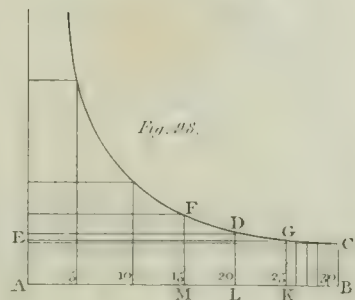
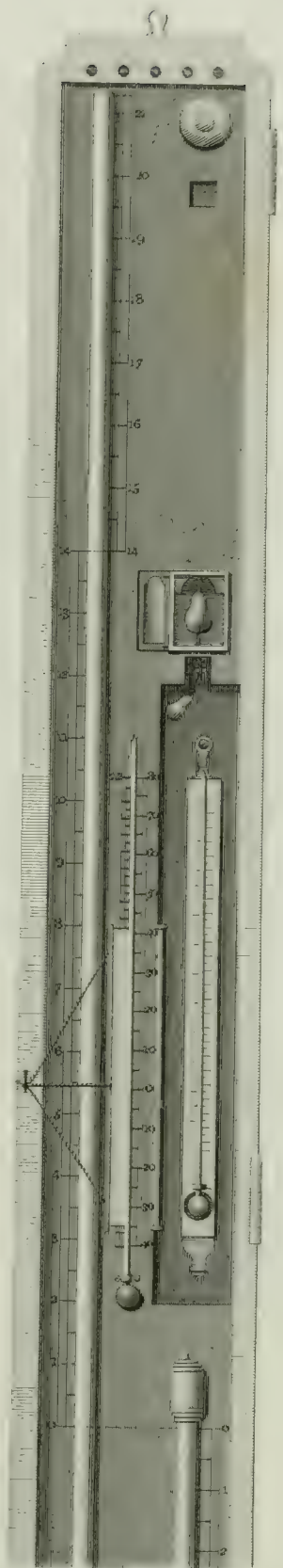

Fig. 98.



BAROMETER.

Fig. 104.

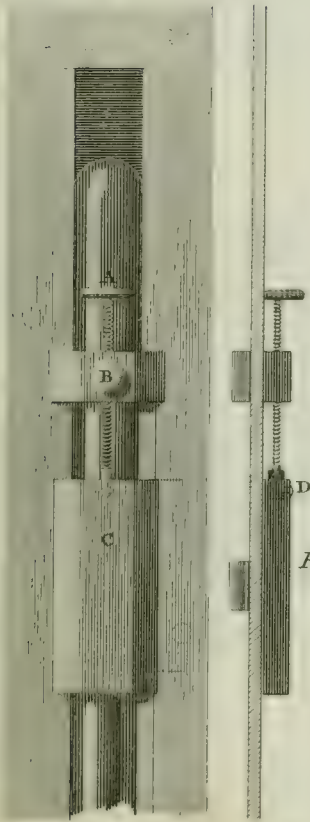

Fig. 105.

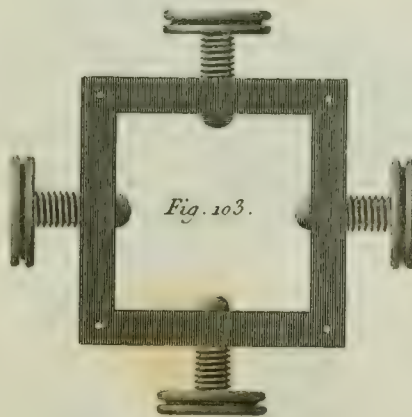

Fig. 103.

Fig. 100.

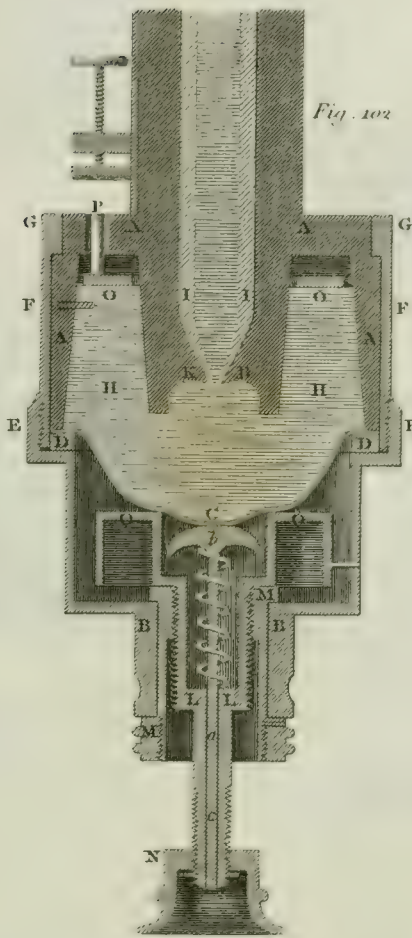
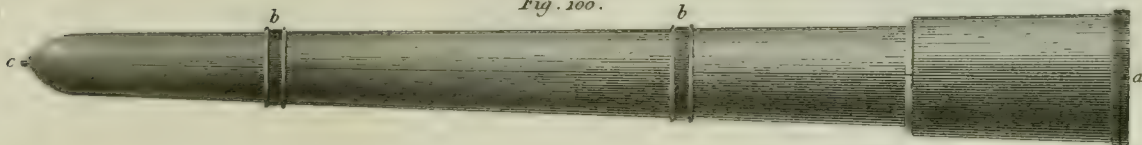

Fig. 102.

Fig. 101.

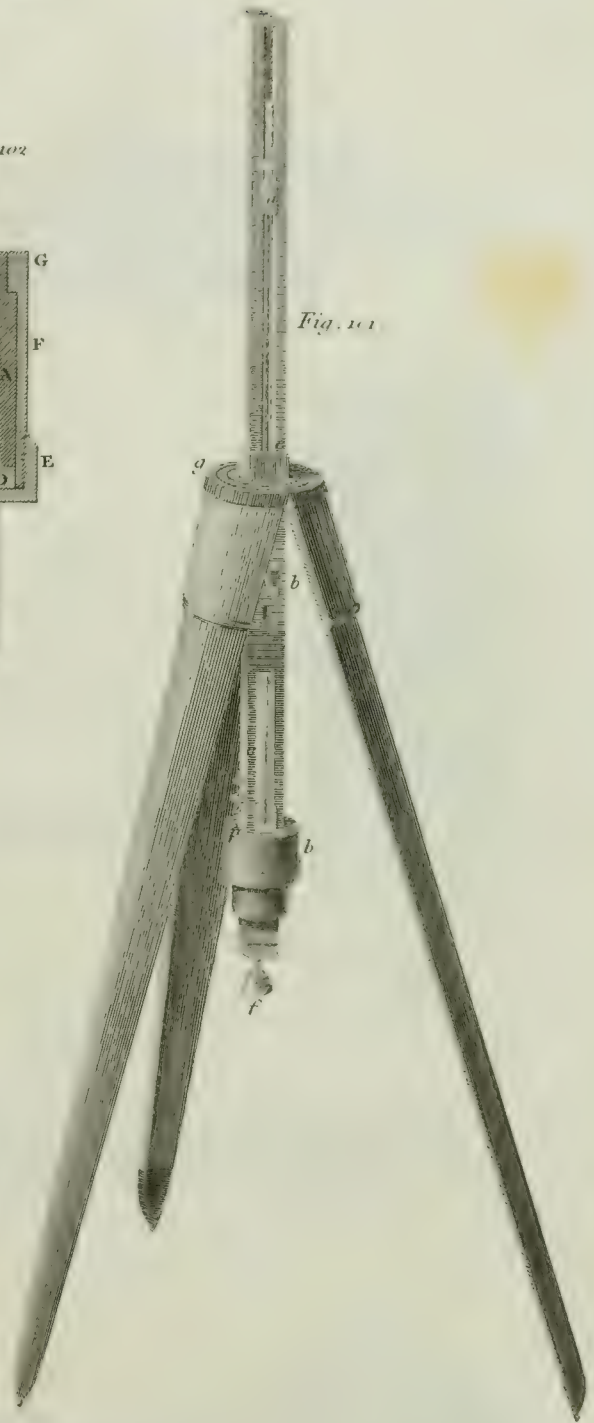

Fig. 107.

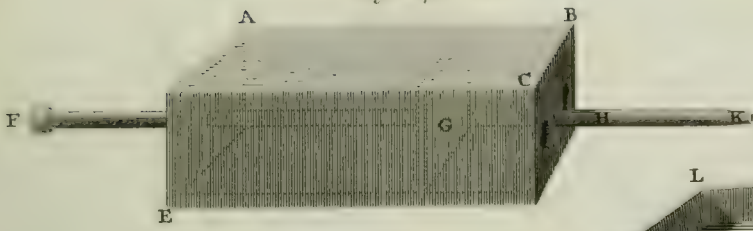

Fig. 109.

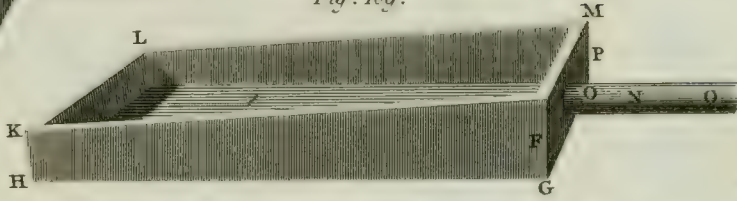

Fig. 108.

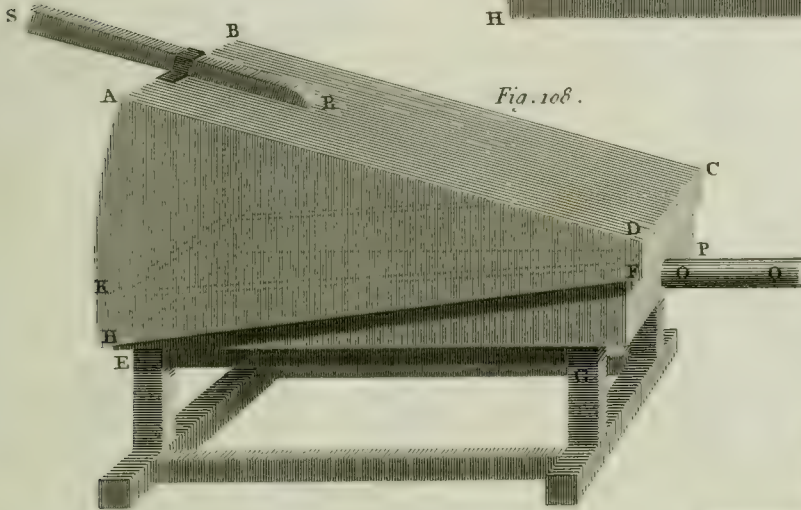

Fig. 110.

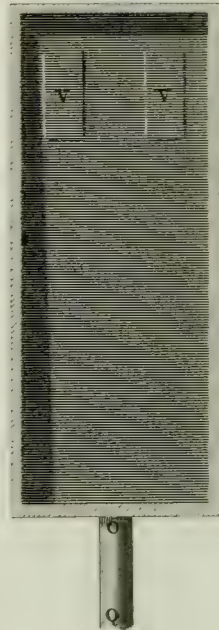

Fig. 111.

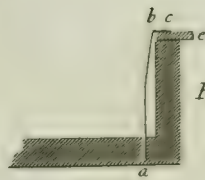

Fig. 112.

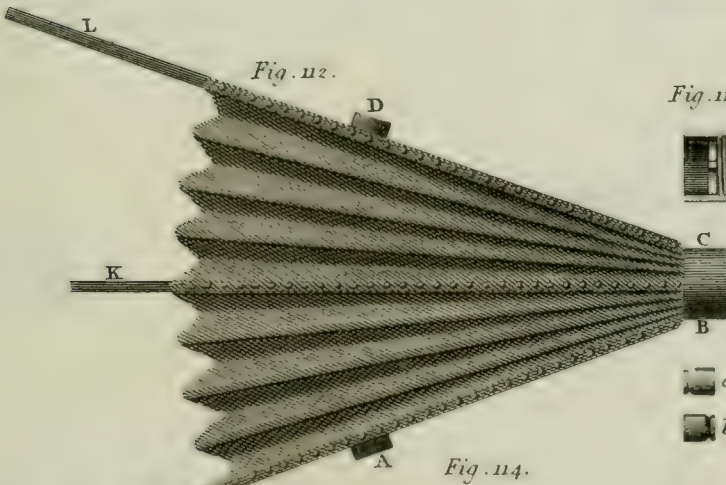

Fig. 117.



Fig. 116.



Fig. 115.



Fig. 113.



Fig. 114.

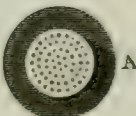
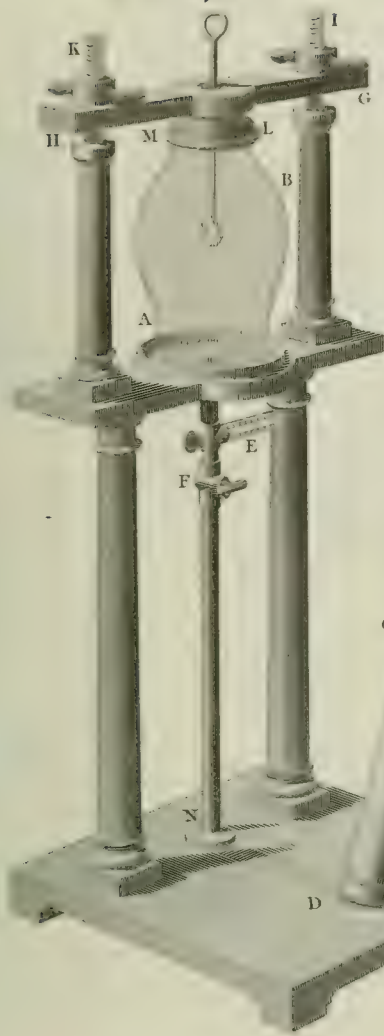

Fig. 3.



FREEZING Apparatus.

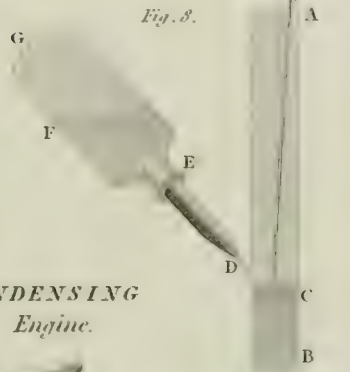

Fig. 3.

CONDENSING Engine.



PEAR Gage.

Fig. 4.

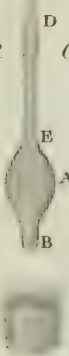

CONDENSER'S.



Fig. 2.

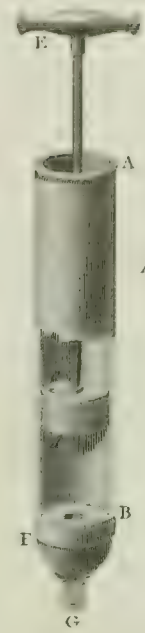

Fig. 1.

GAGE of Condenser.

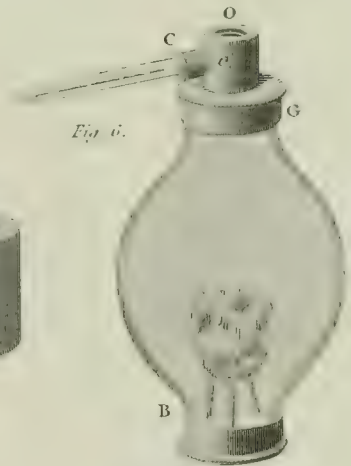

Fig. 5.

Fig. 5.

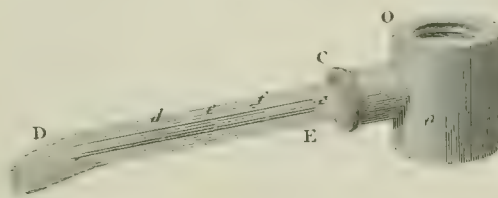

Fig. 7.

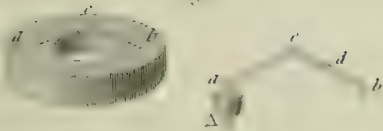
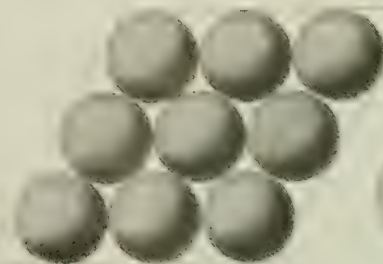
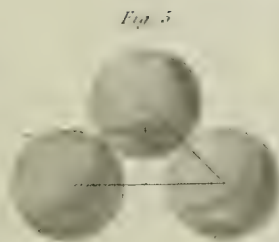

Fig. 4.

FREEZING.

Fig. 6.

Fig. 7.



PNEUMATICS.
PYRMONT WATER.

Fig 1



Fig 2

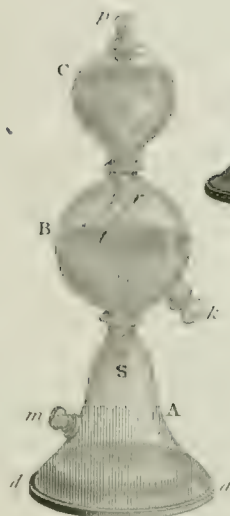

Fig 3



Fig 5

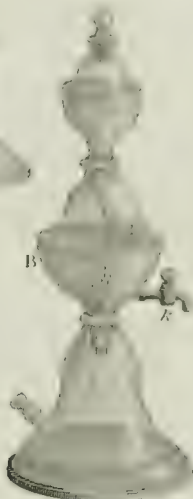

Fig 6

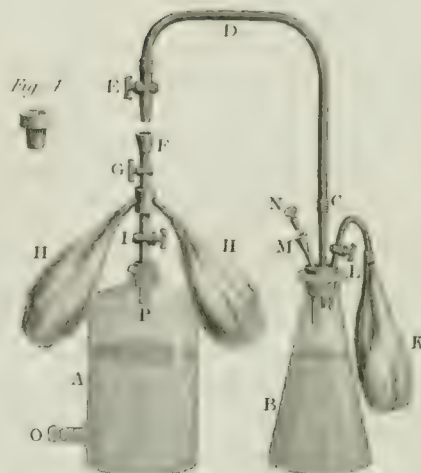
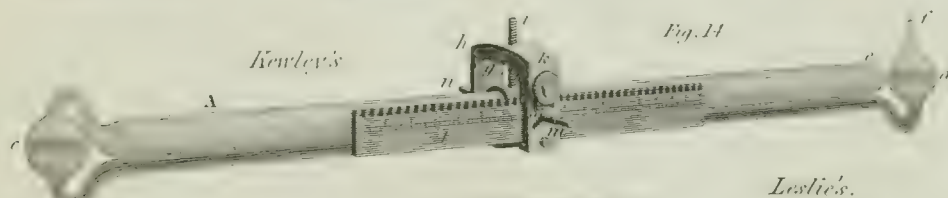

Fig 7



Lind's WIND GAGE.

Fig 9

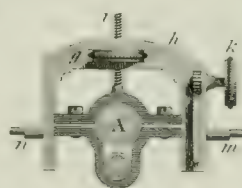
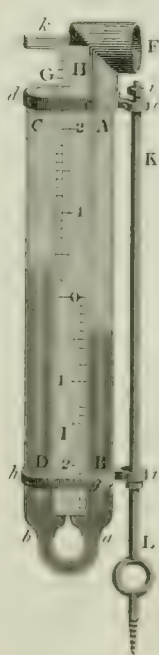
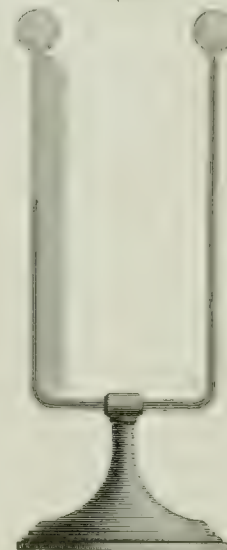

Fig 10



Leslie's.
Fig 13



Martin's WIND GAGE.

Fig 11

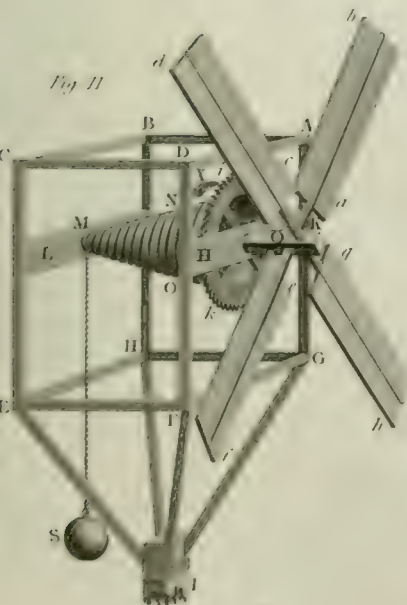

WHISPERING PLACE.

Fig 3



Fig 12

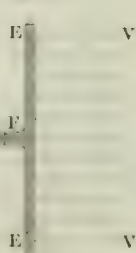

Bouguer's WIND GAGE.

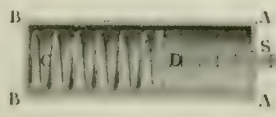

THERMOMETER.

Fig. 4.

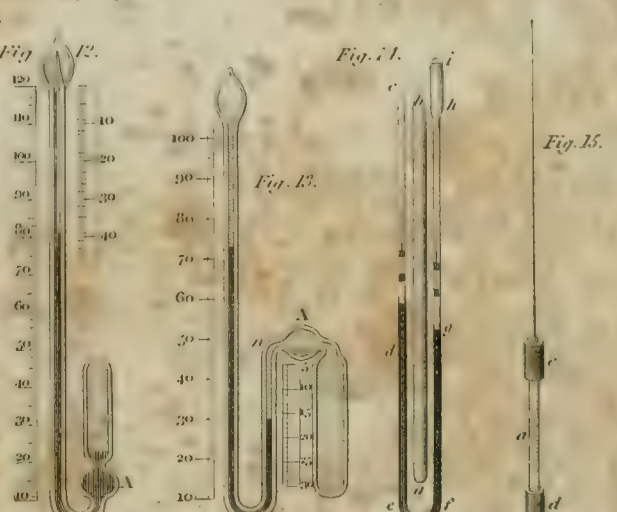
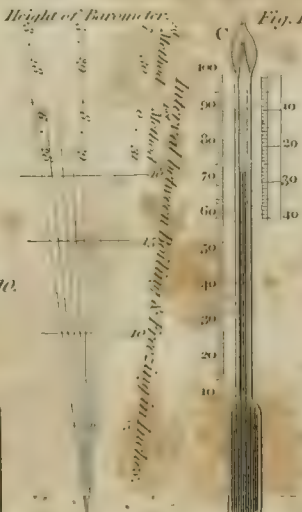
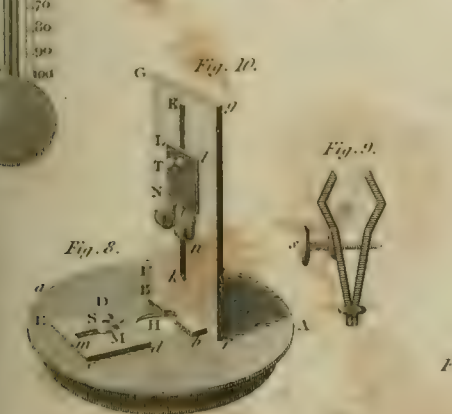
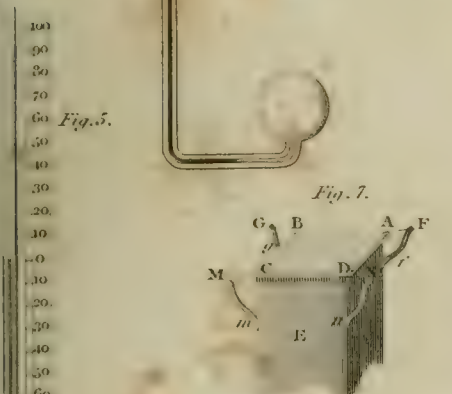
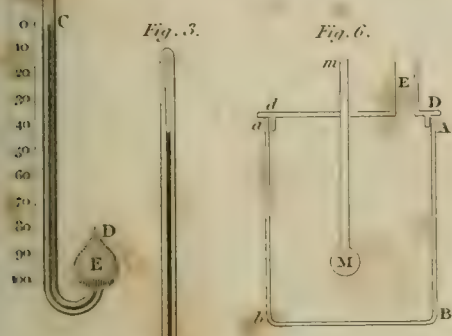
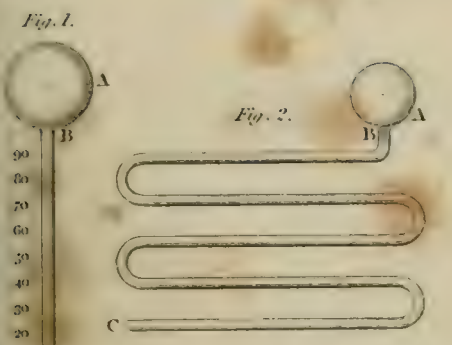
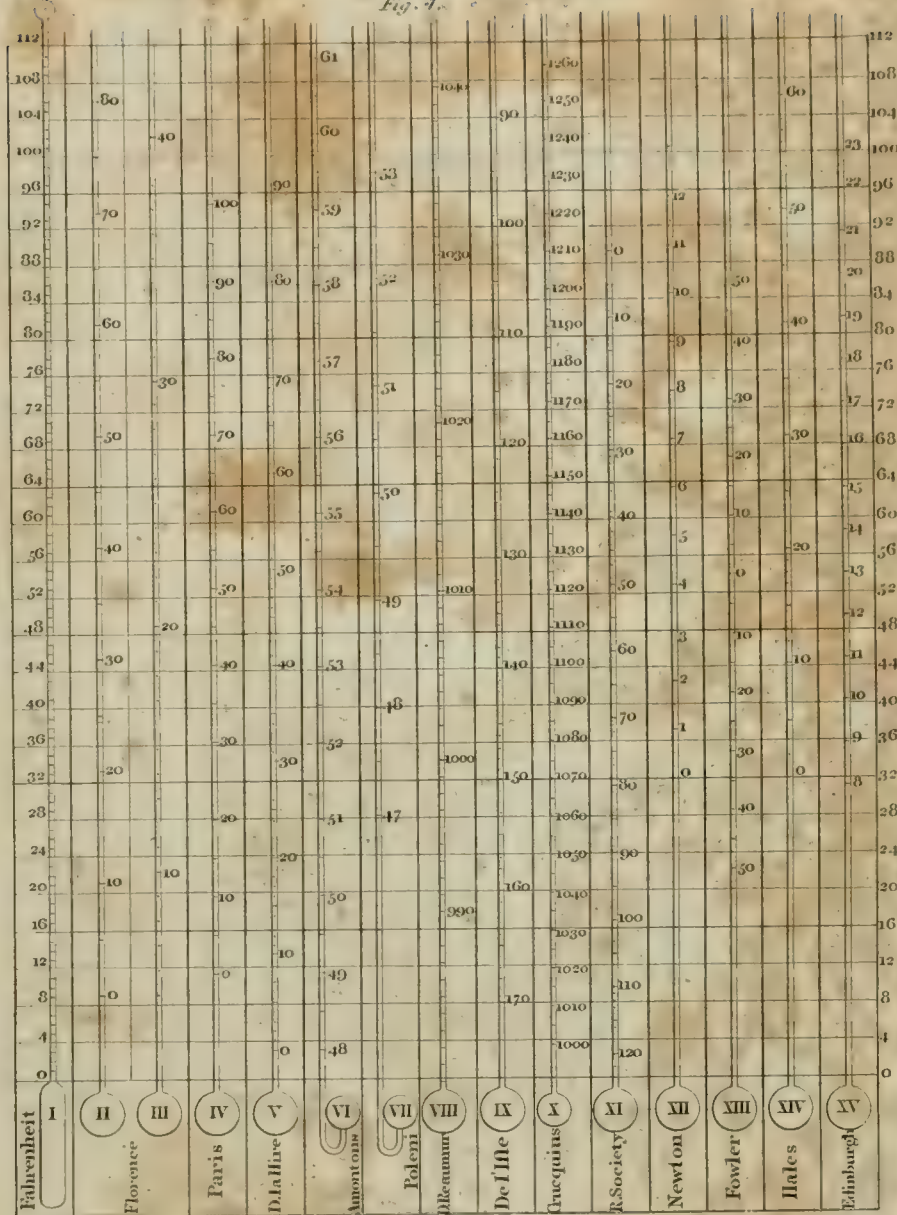



PNEUMATICS .
VENTILATOR .

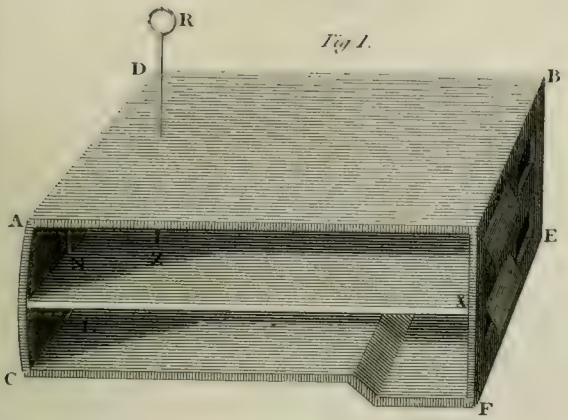

Fig. 1.

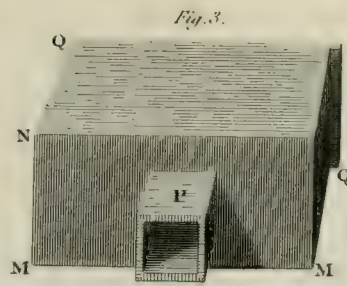

Fig. 3.

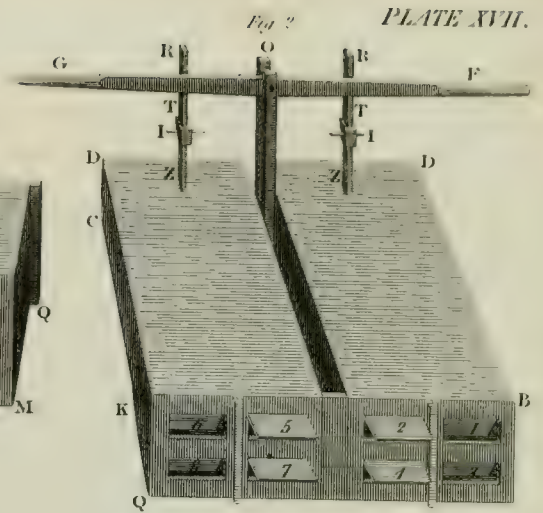

Fig. 2.

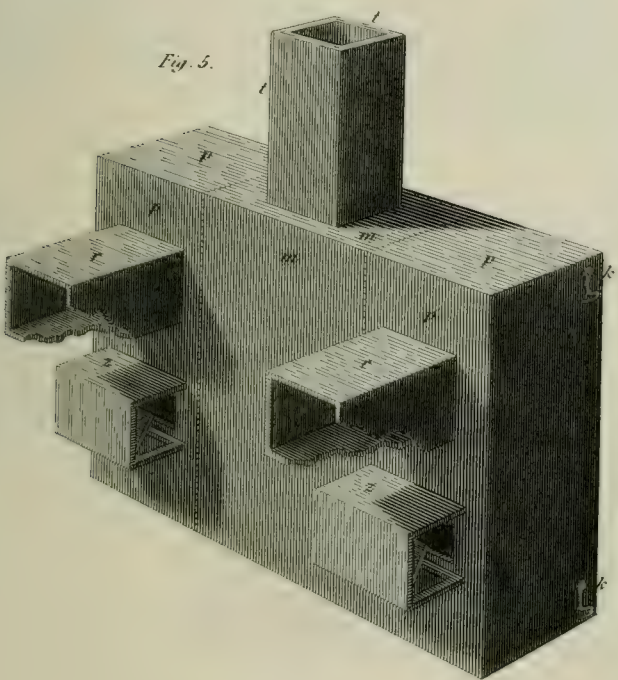

Fig. 5.

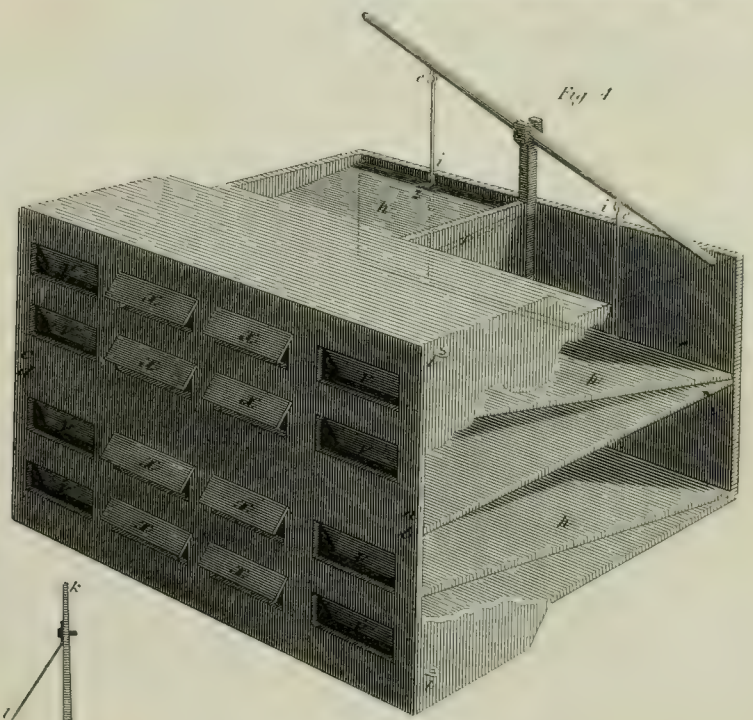

Fig. 4.

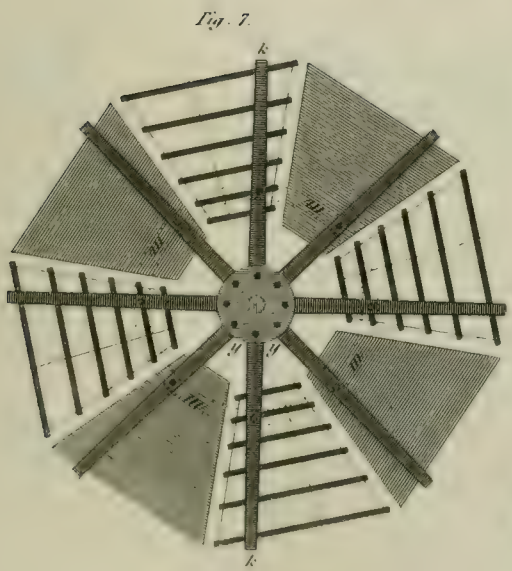

Fig. 7.

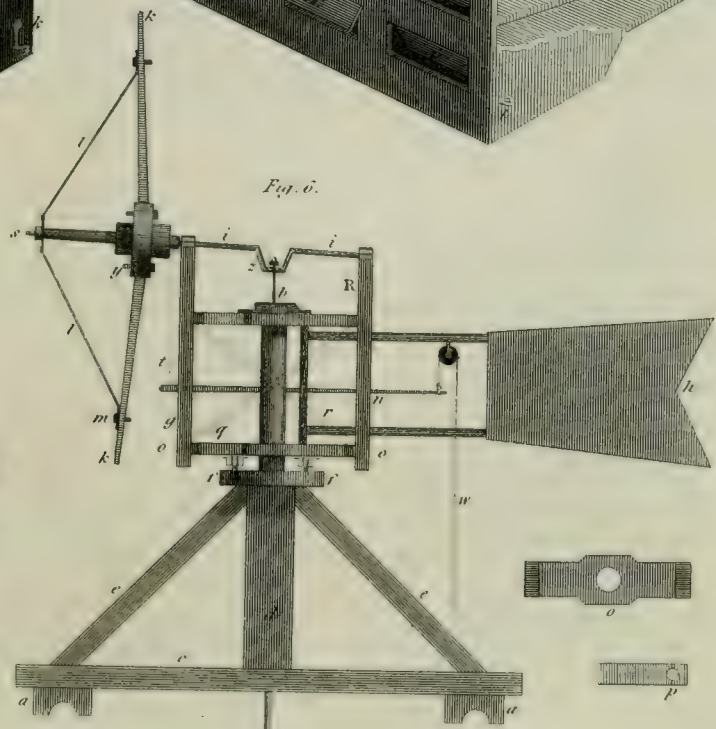

Fig. 6.

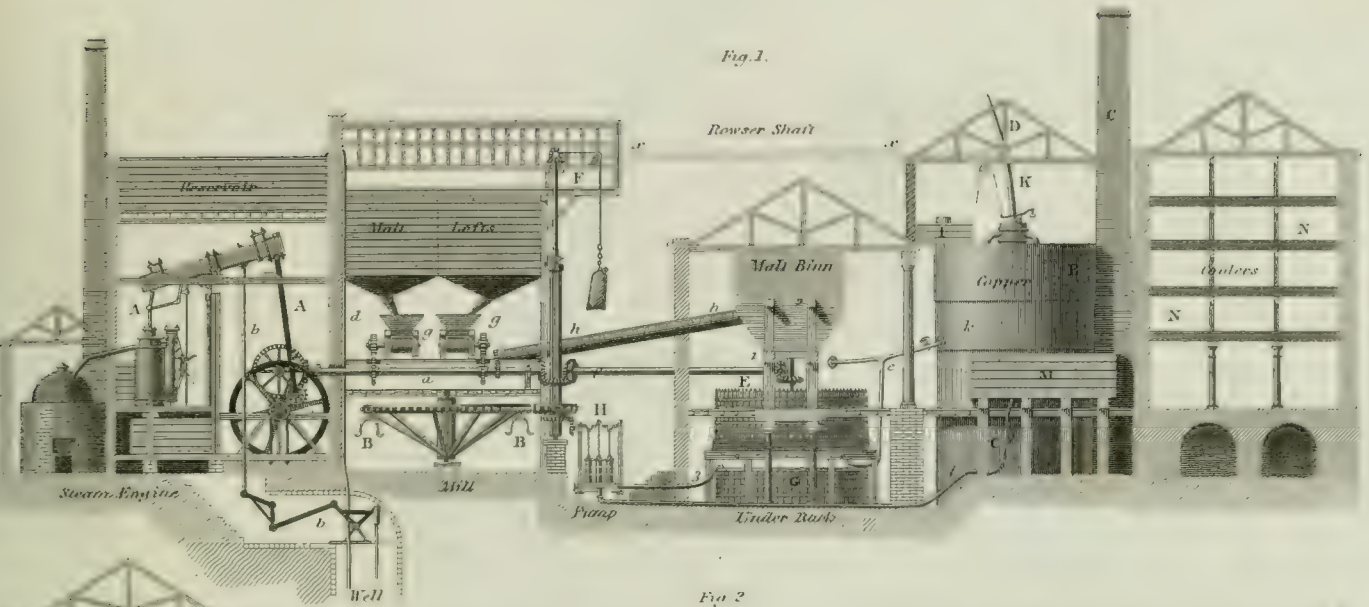

Fig 2

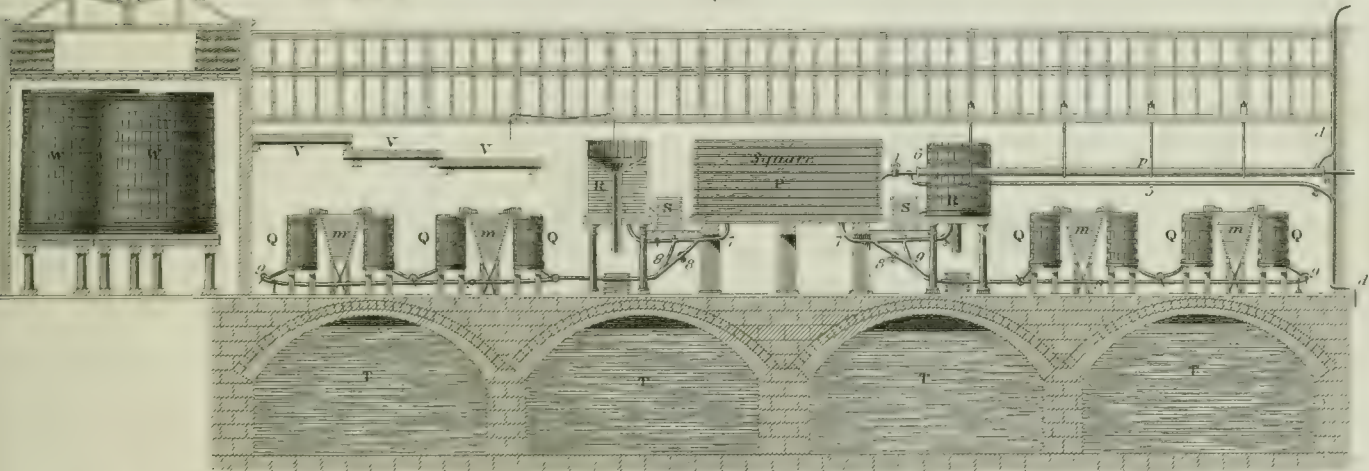
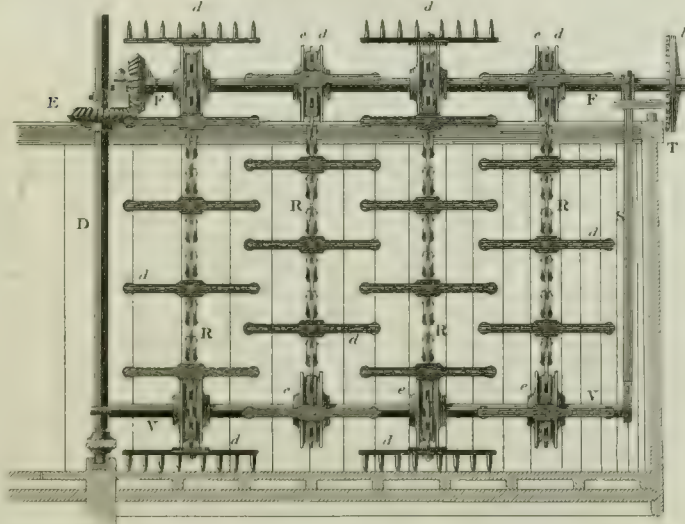
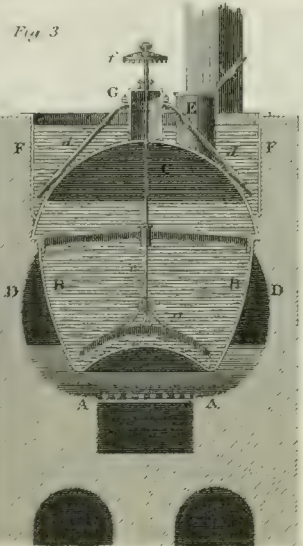
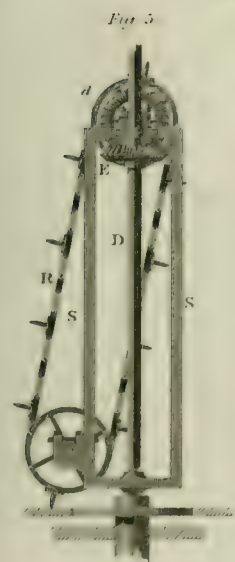
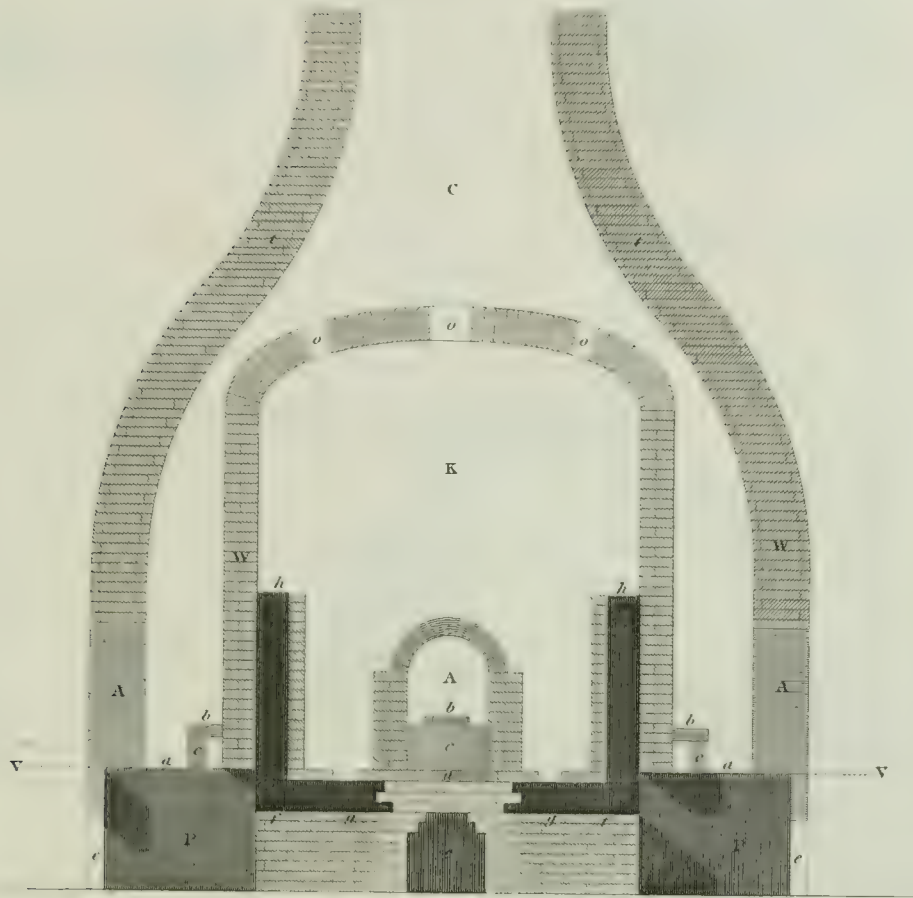

Fig 1



POTTERY

Vertical Section.



Horizontal Section

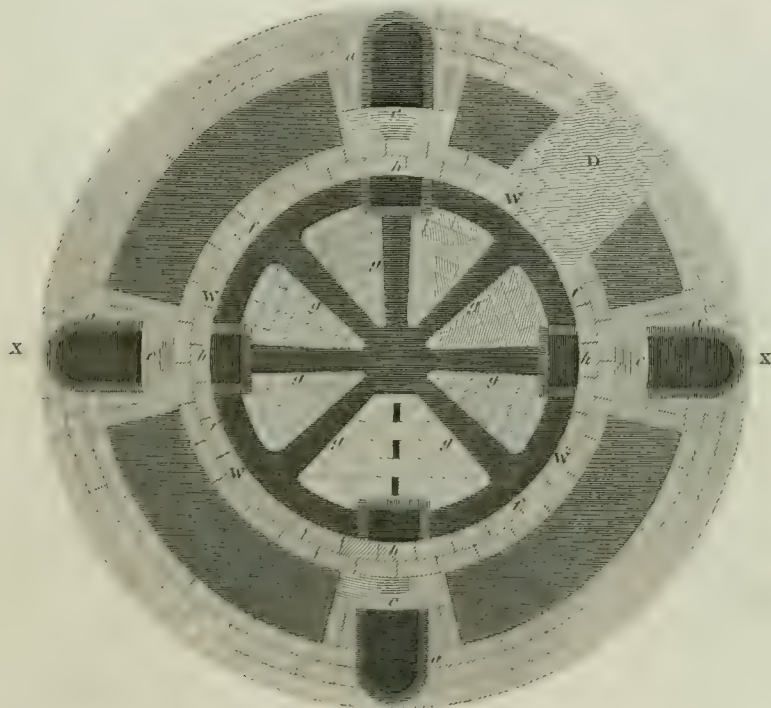



M^r BRAMM'S HYDROSTATIC PRESS.

Fig. 3. Plan.

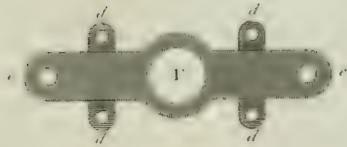

Fig. 4. Plan.

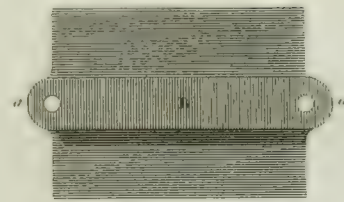
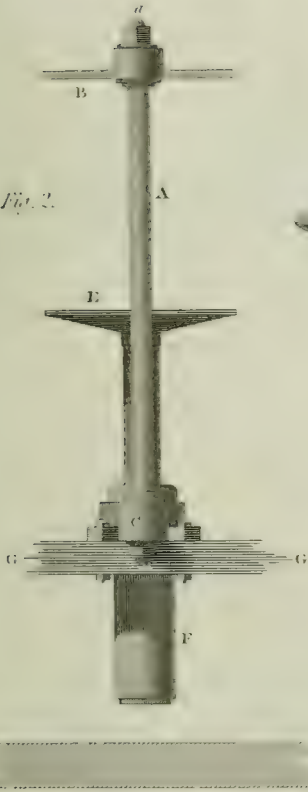
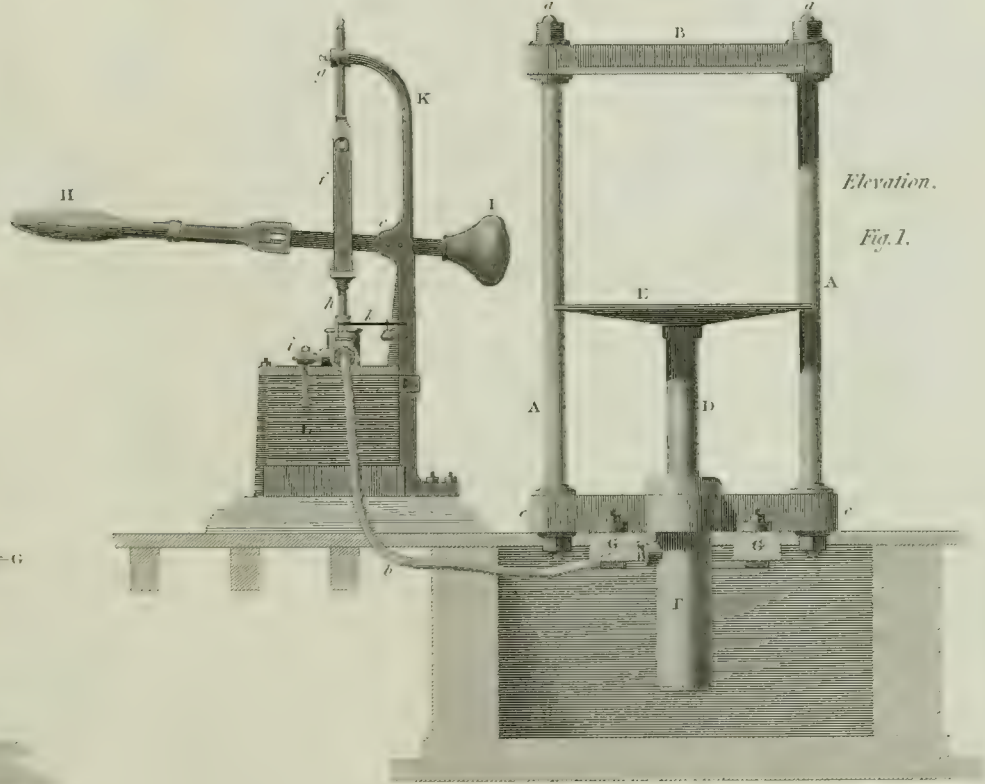

Fig. 2.



Elevation.

Fig. 1.



Sections of the

Cylinder

Fig. 5.

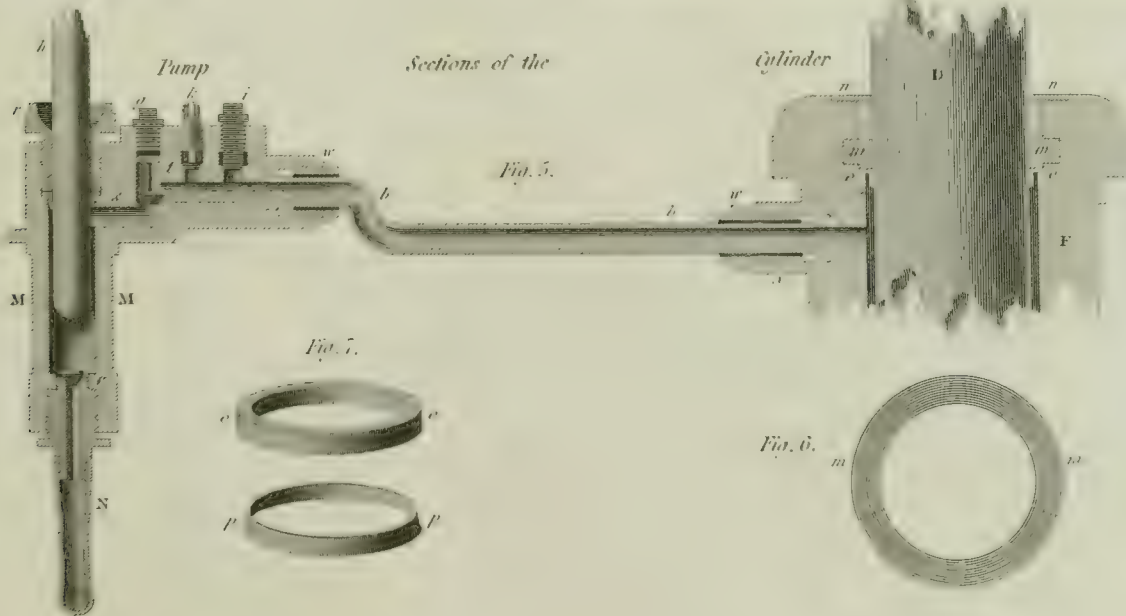

Fig. 7.



Fig. 6.

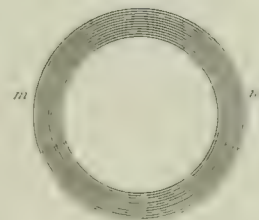

Fig. 3. Plan

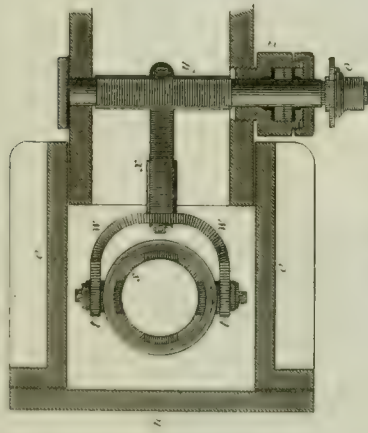

Fig. 4.

Section of the Valve

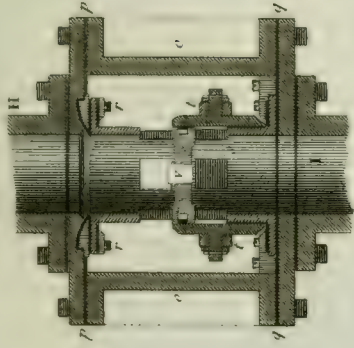
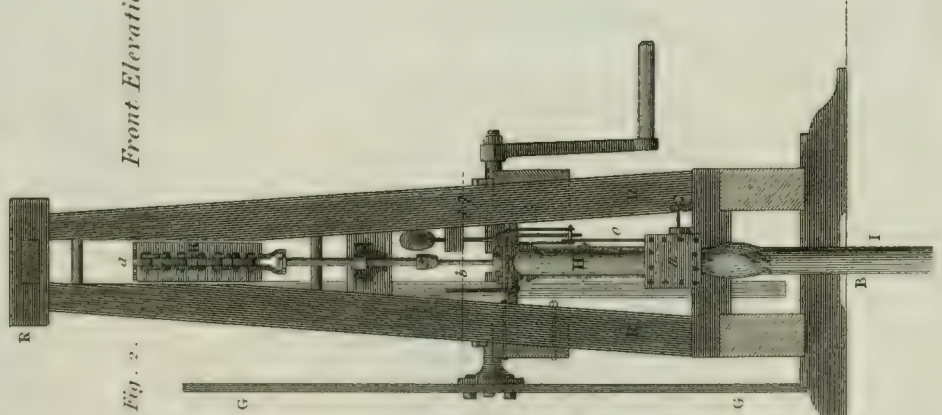
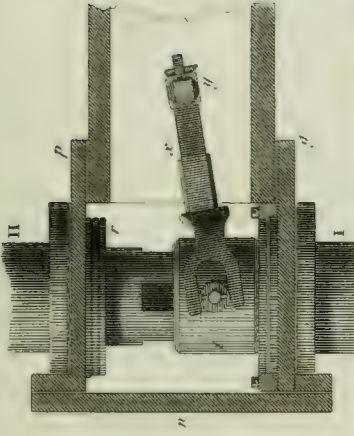
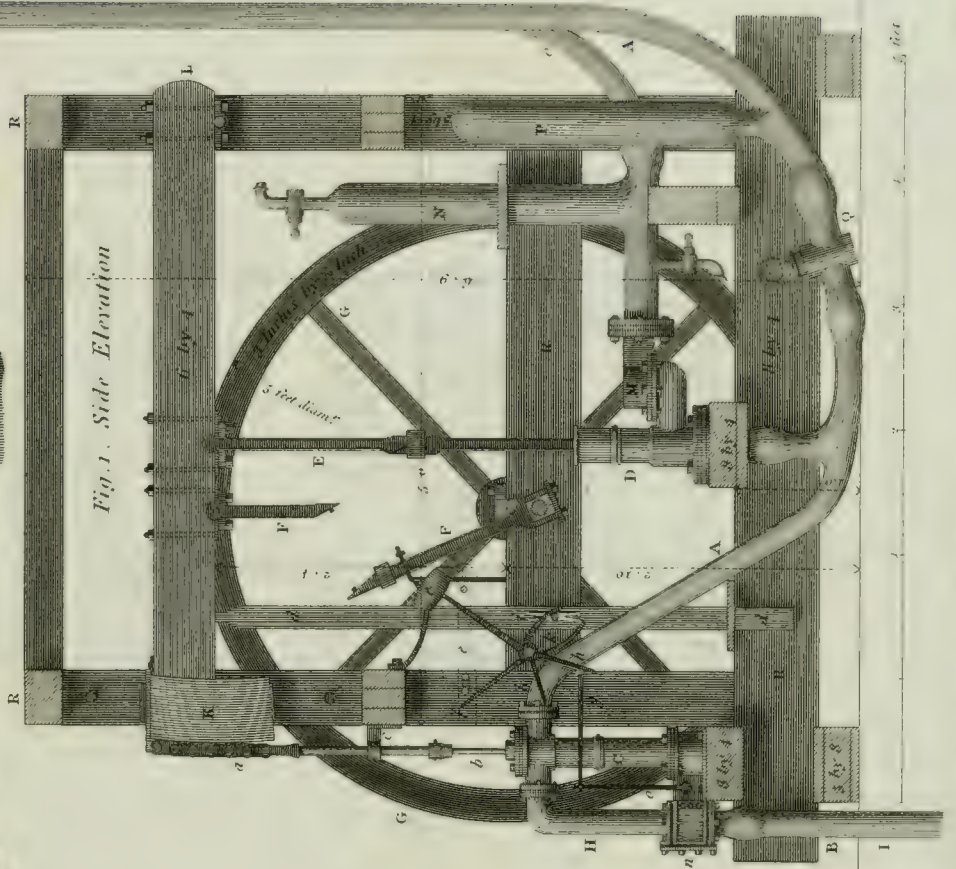

Fig. 5. Section



Front Elevation



Side Elevation

The STANHOPE or IRON PRESS.

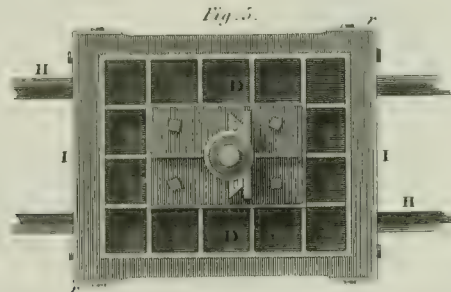
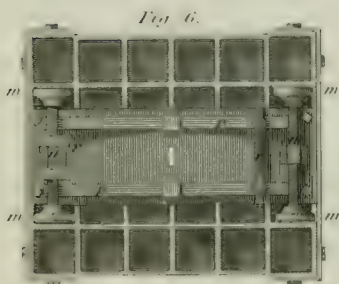
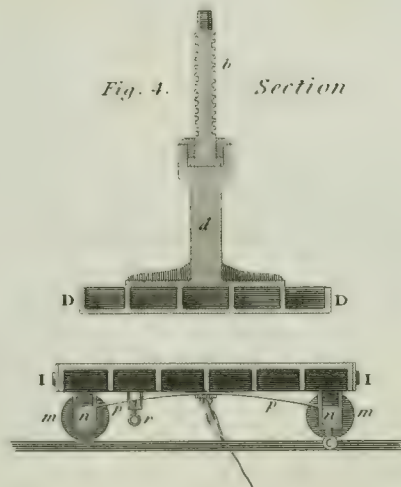
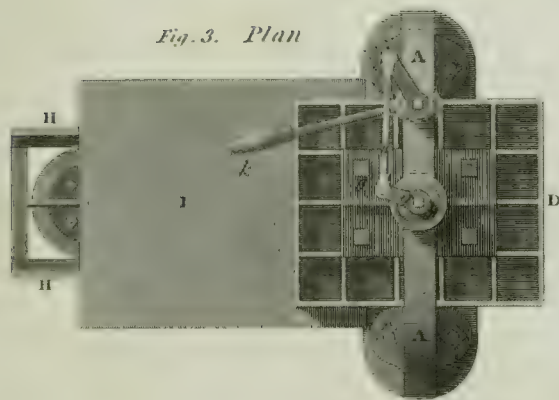
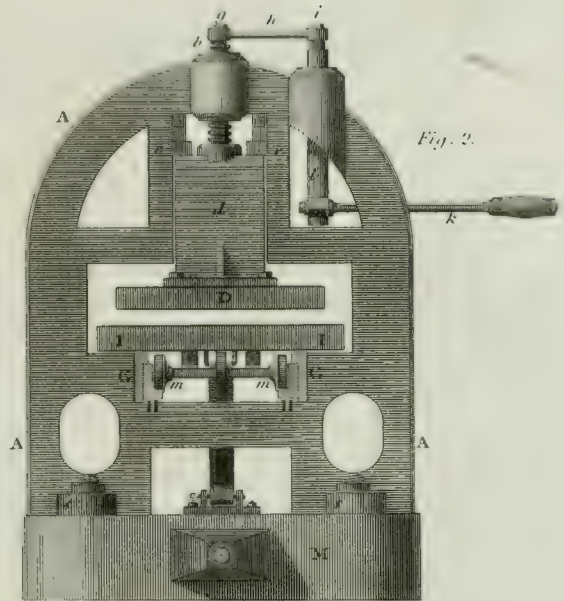
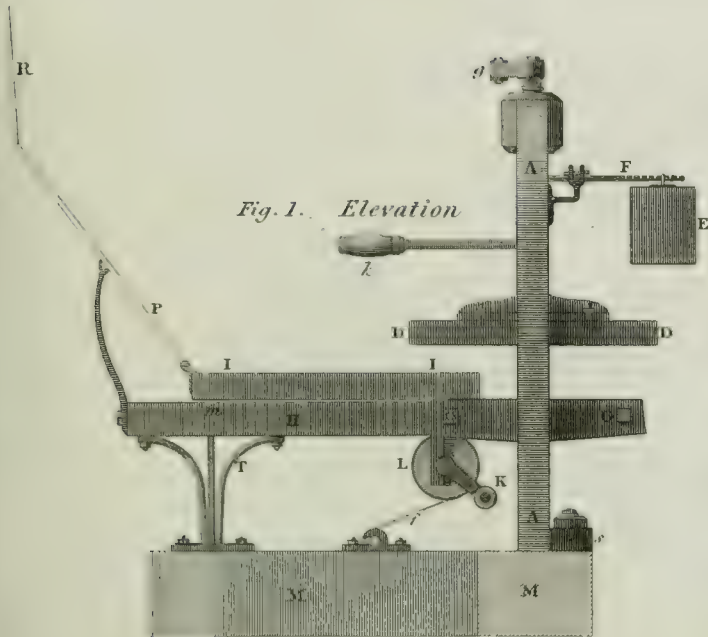

M^r Bramah's Bank note Printing machine.

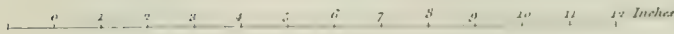

Section

Fig. 1.

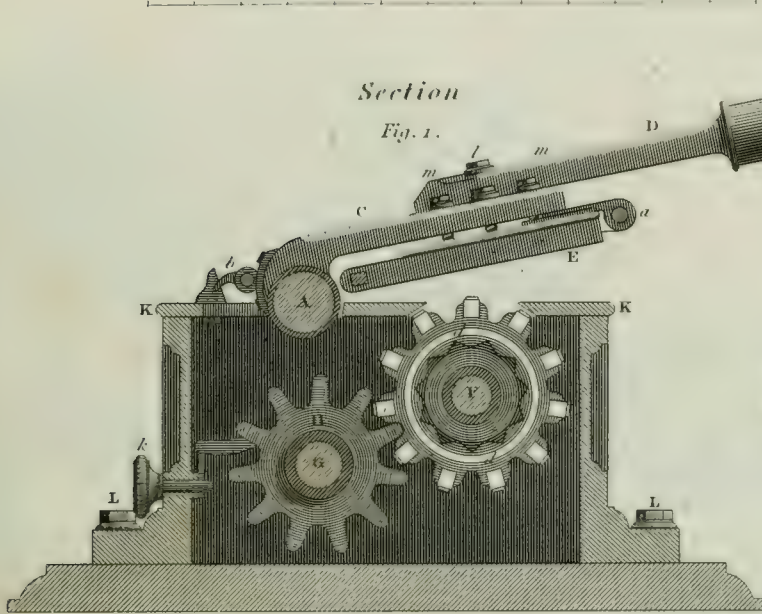

Plan

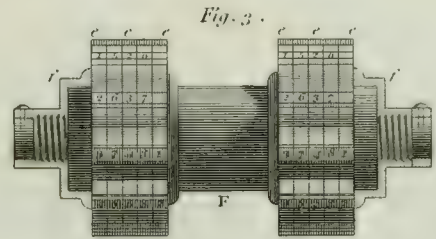
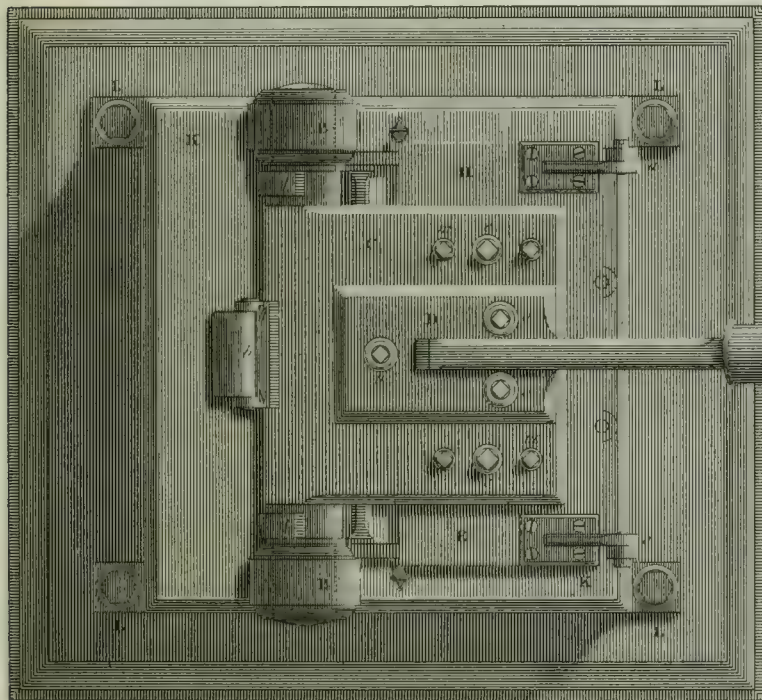

Fig. 5.

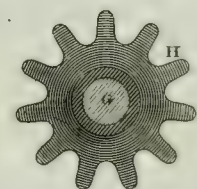

Fig. 2.

Fig. 6.

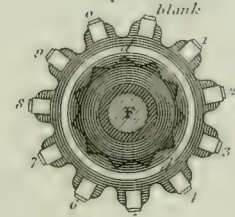
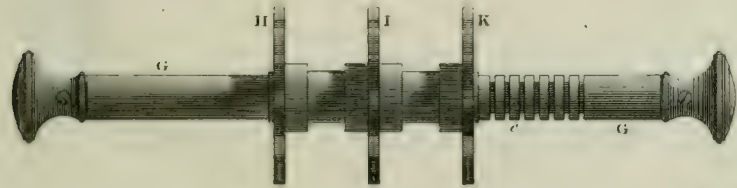
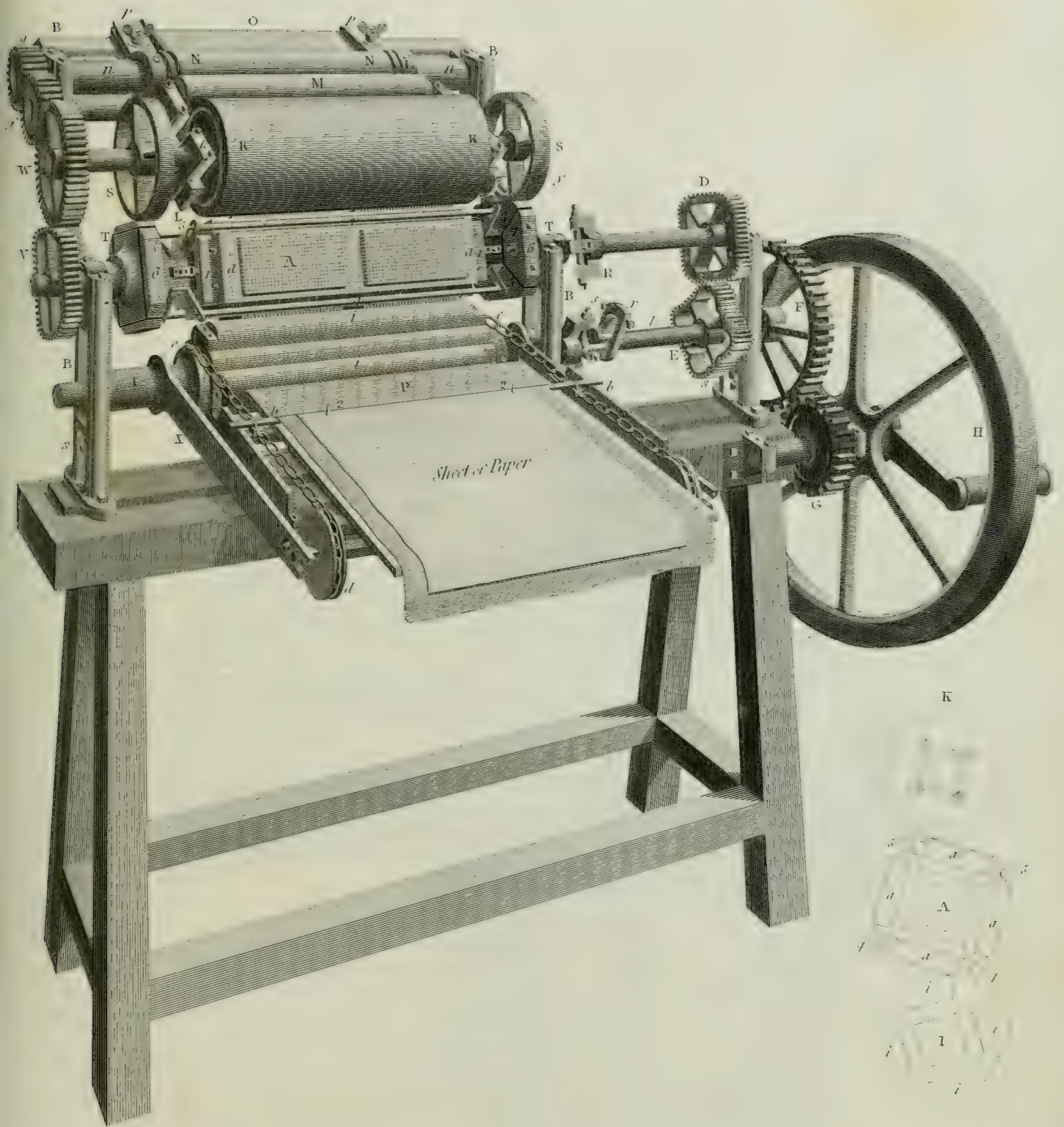

Fig. 4.



Messrs Bacon & Donkins, PRINTING MACHINE .



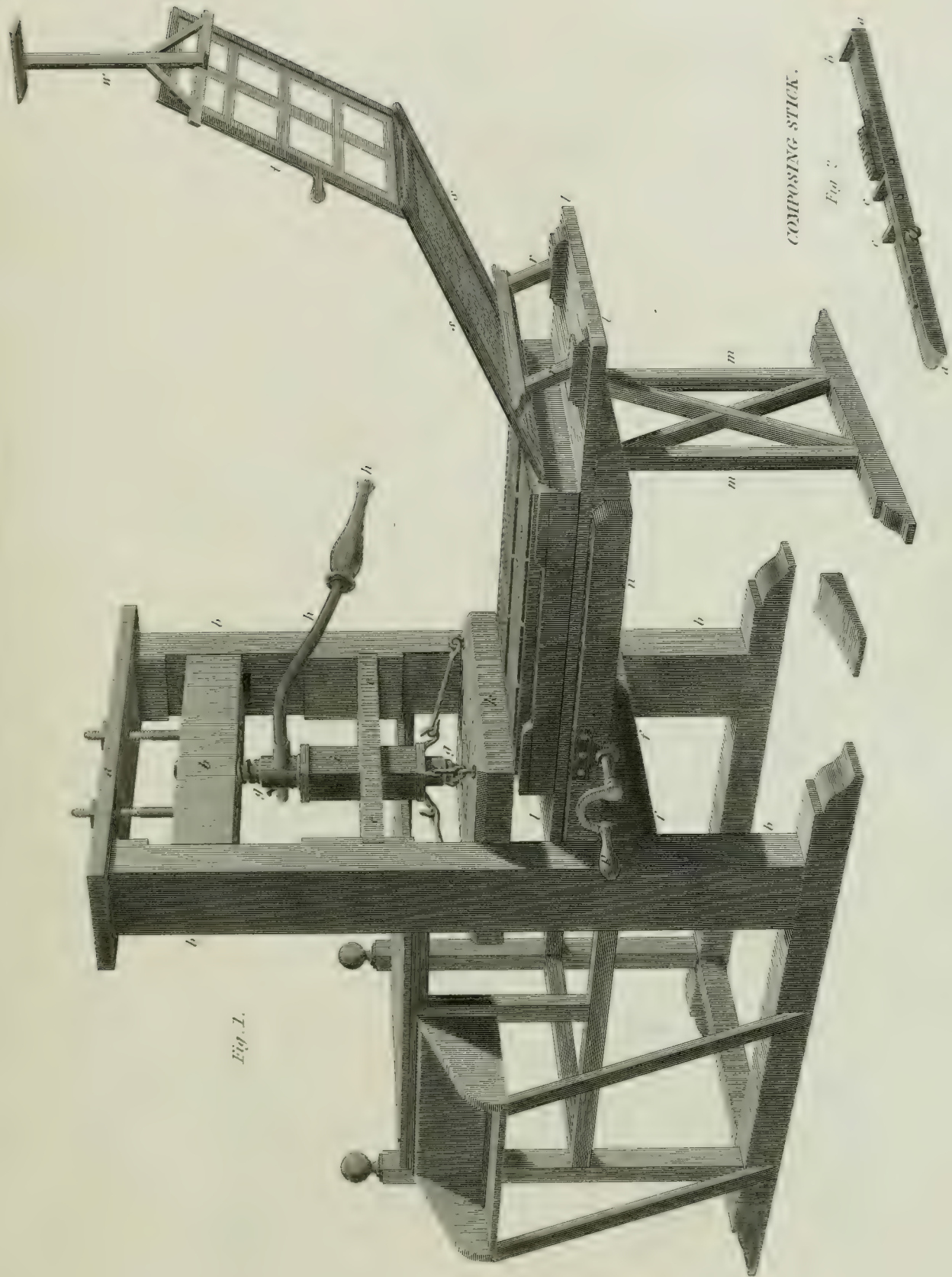
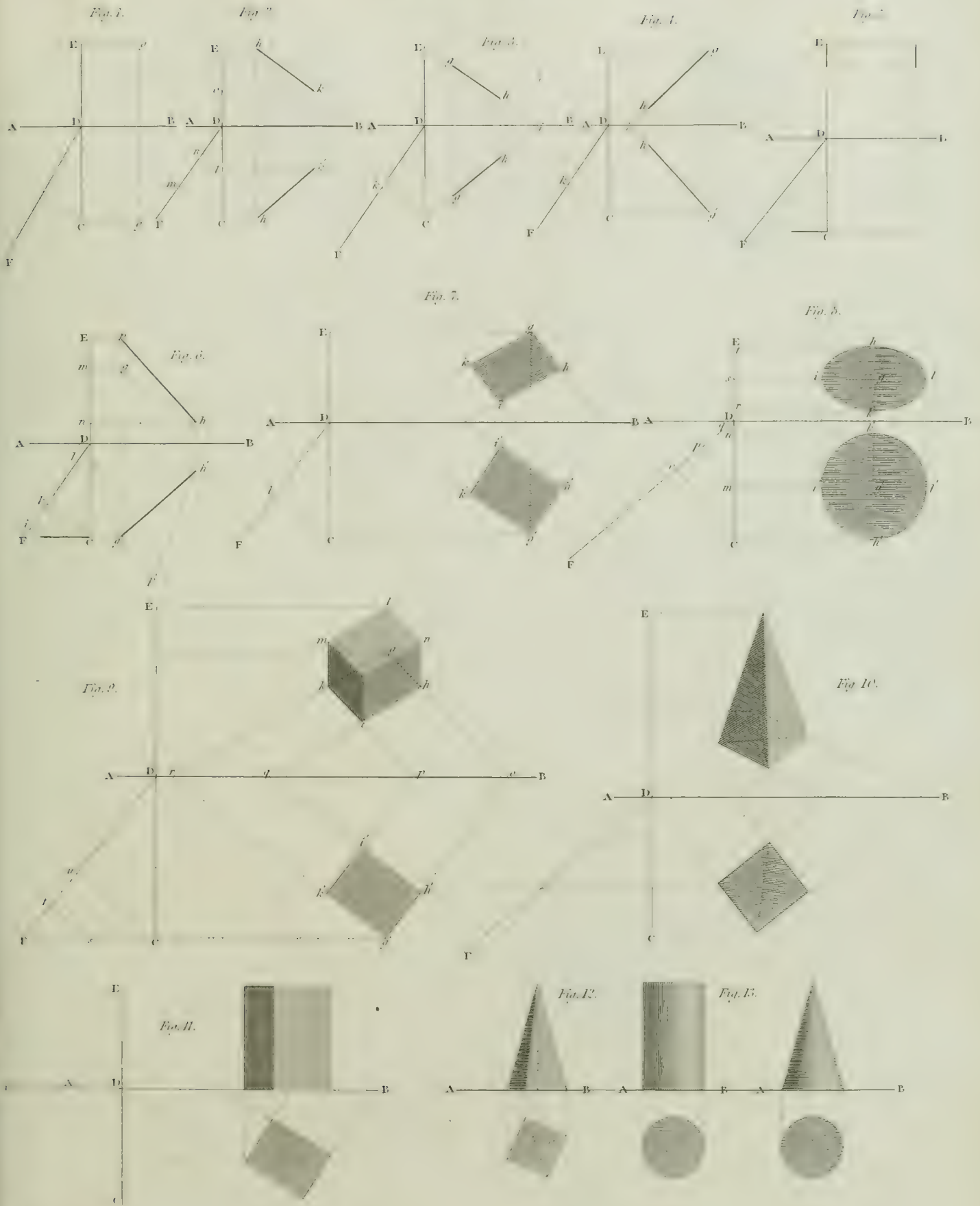
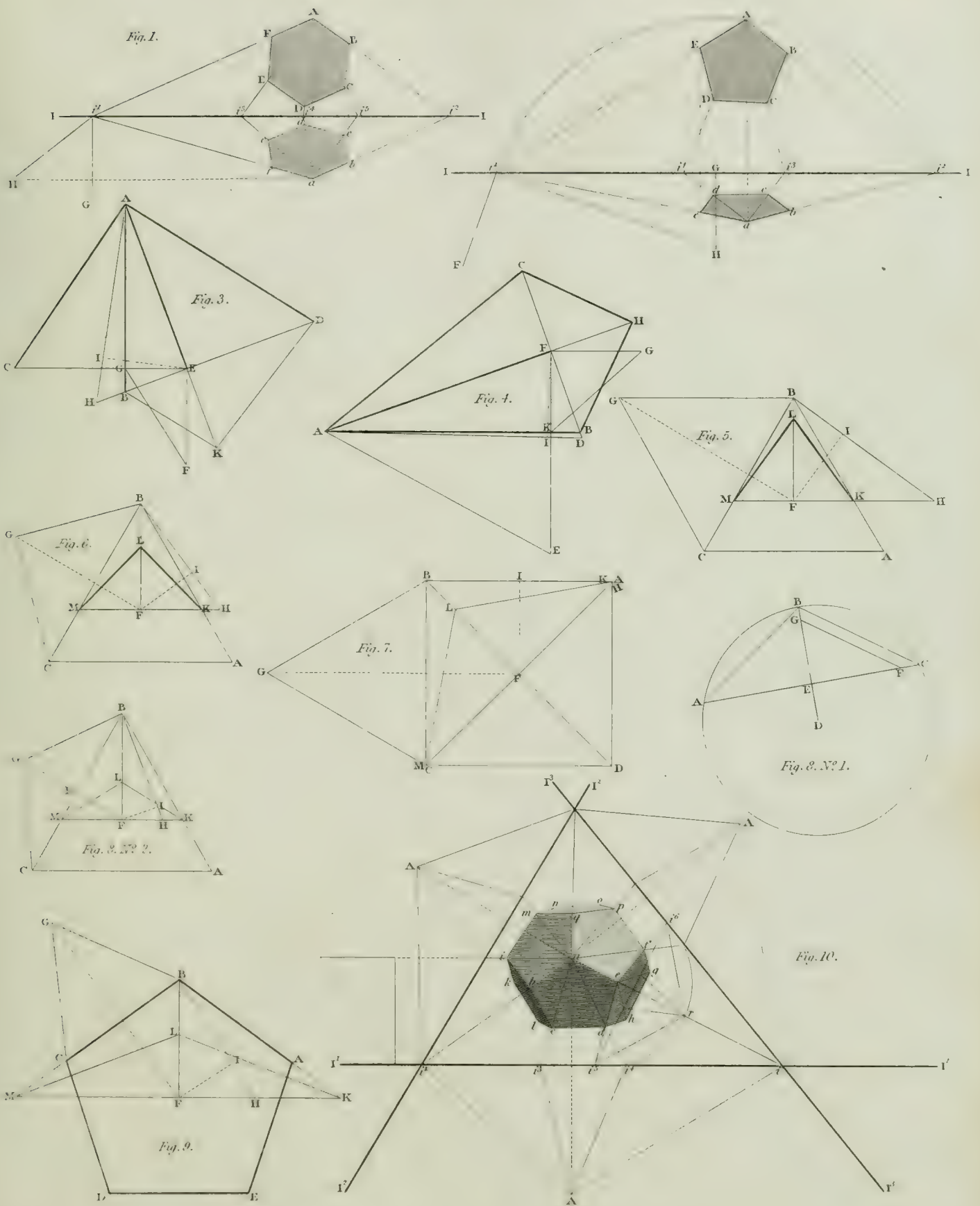

Fig. 1.

COMPOSING STICK.

Fig. 2.





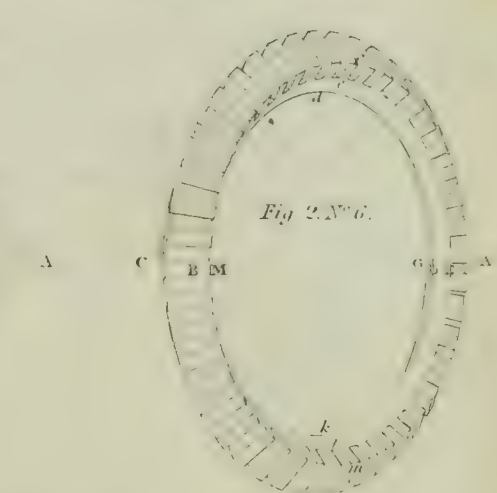
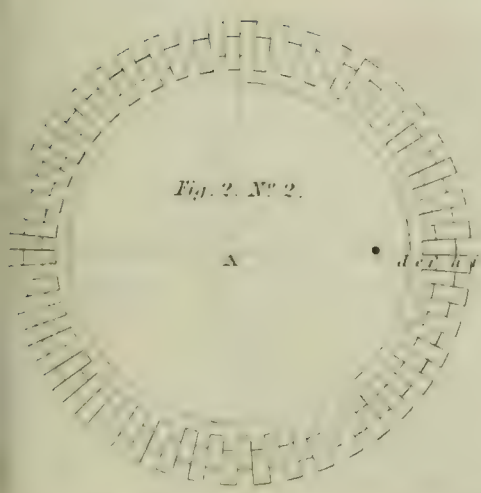
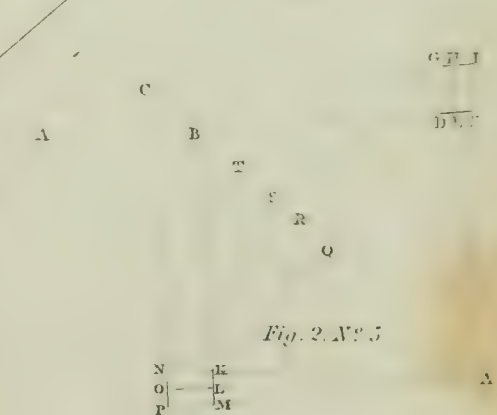
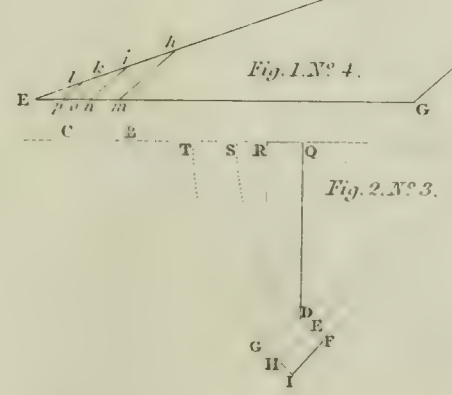
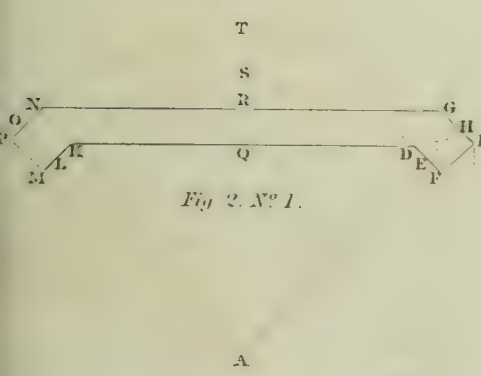
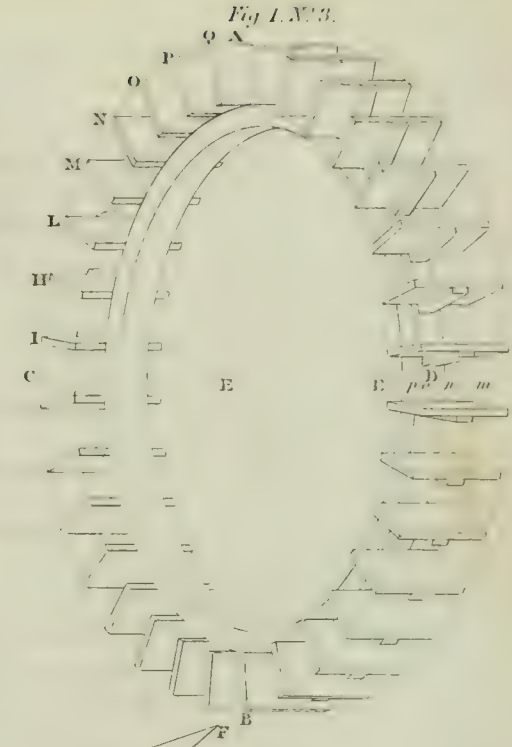
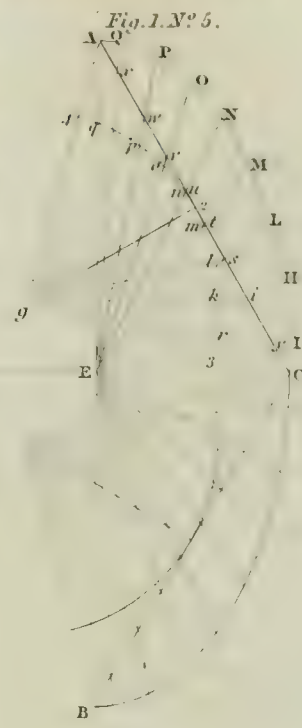
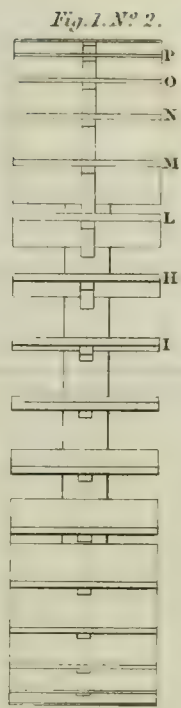
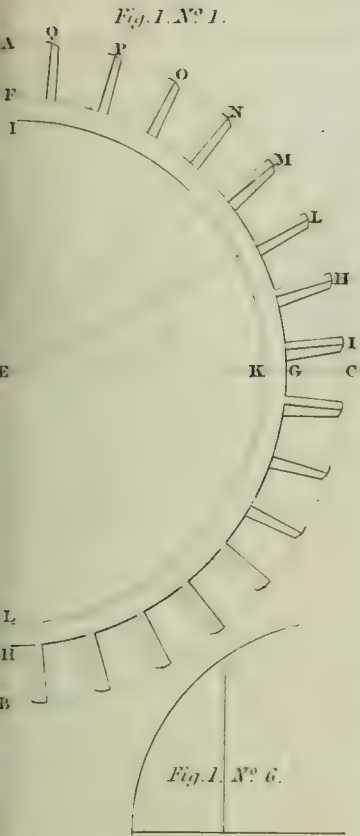

Fig. 1.

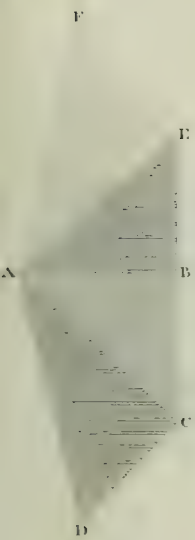

Fig. 1. N^o 2.

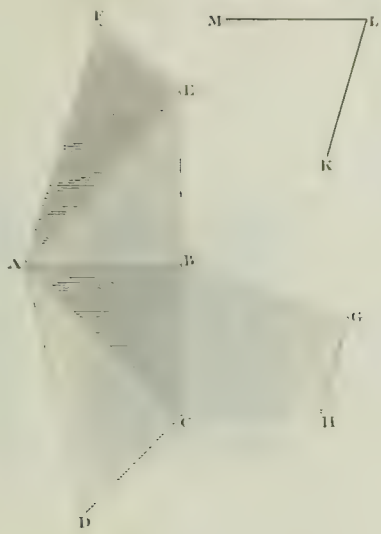

Fig. 1. N^o 3.

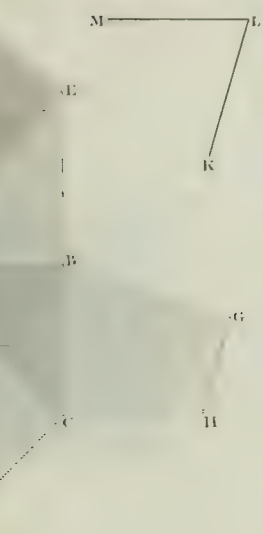

Fig. 2.

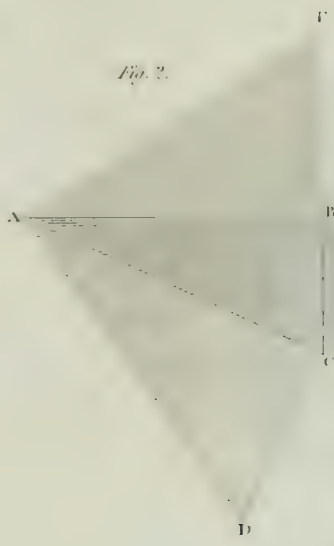

Fig. 3.

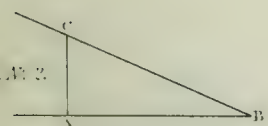
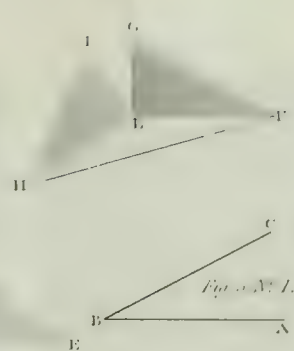

Fig. 1. N^o 3.

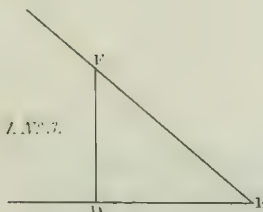

Fig. 4.

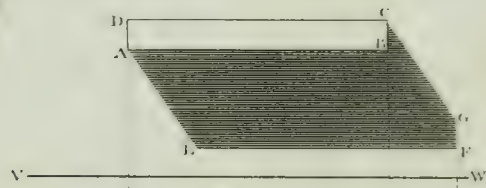
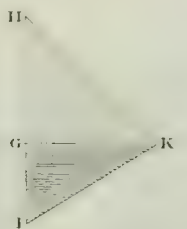

Fig. 5.

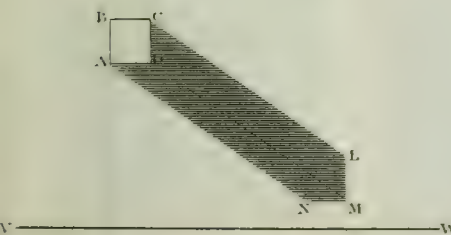
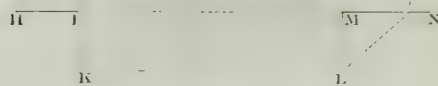

Fig. 6.

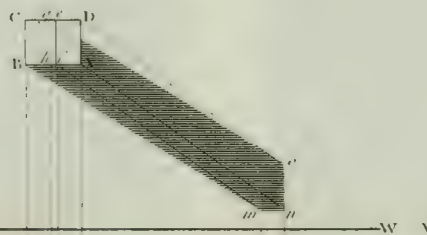

Fig. 7.

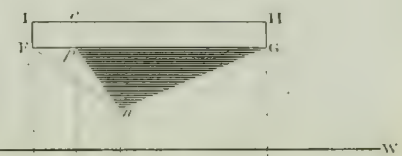

Fig. 8.

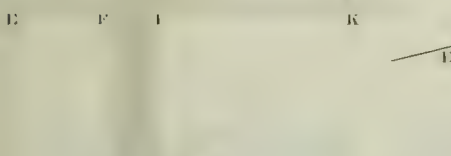

Fig. 9.

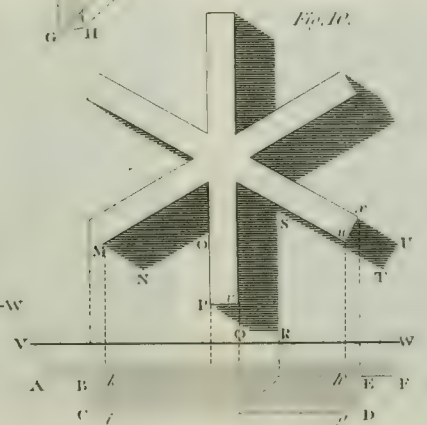

Fig. 10.

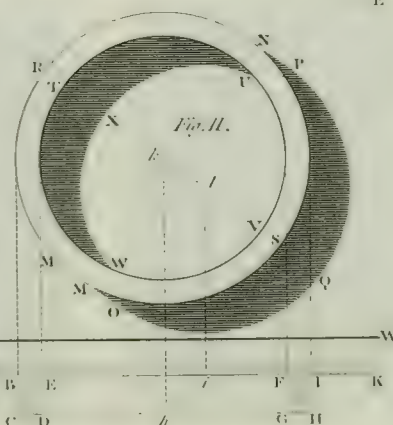

Fig. 11.

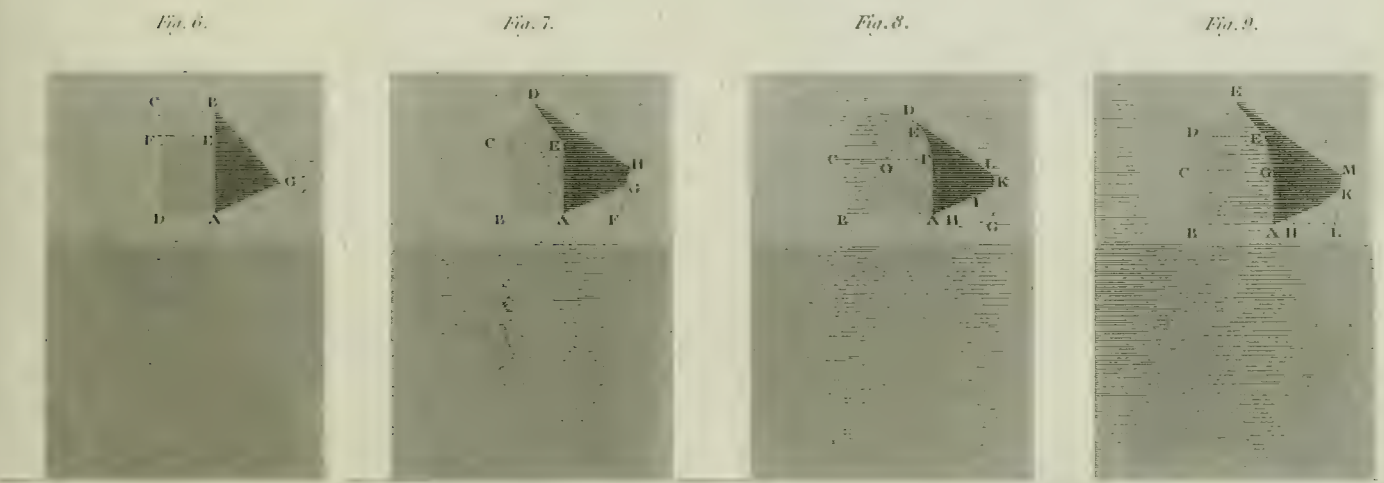
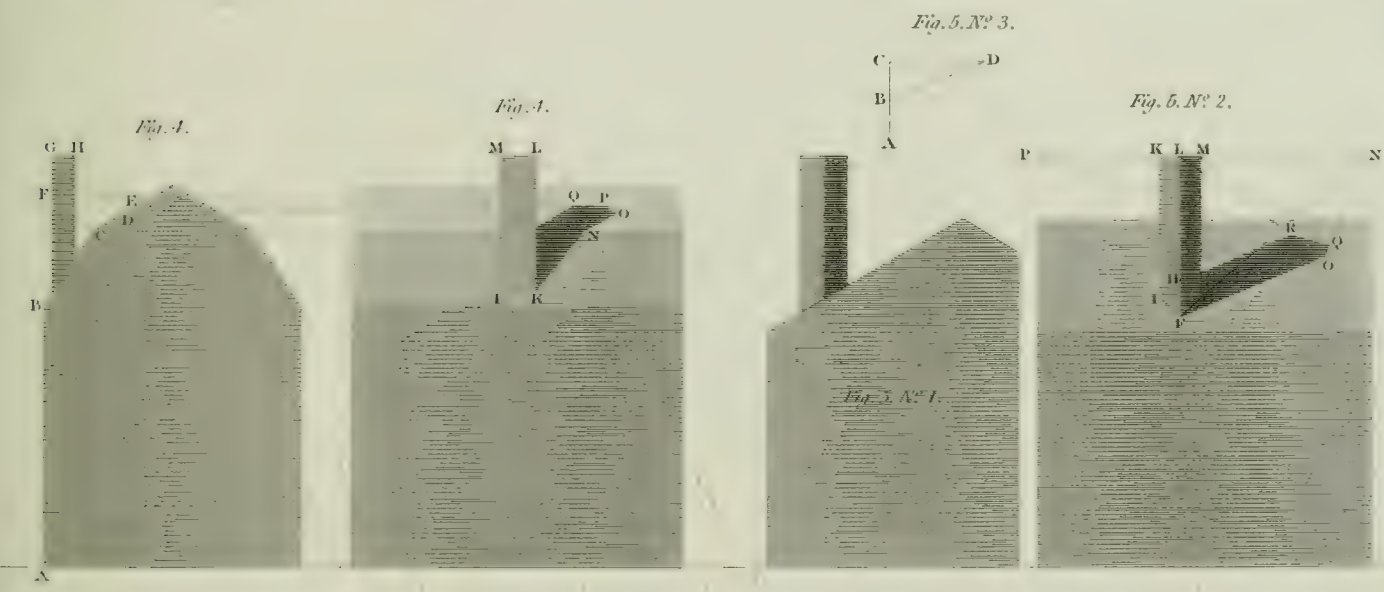
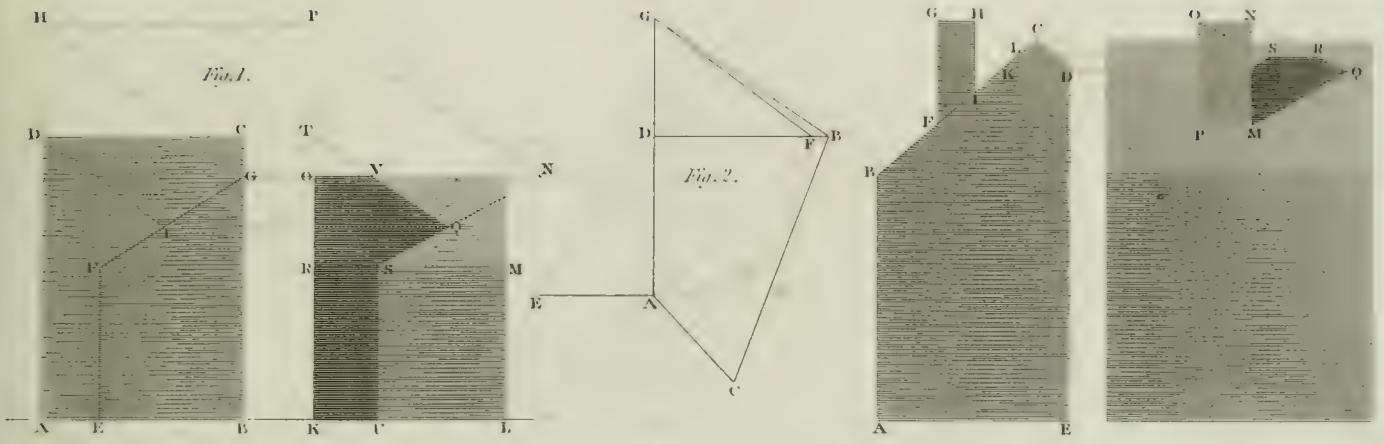

Fig. 1.

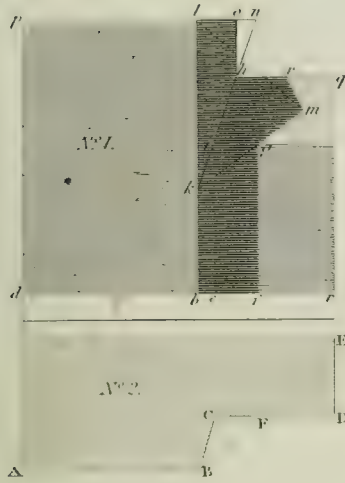

Fig. 2.

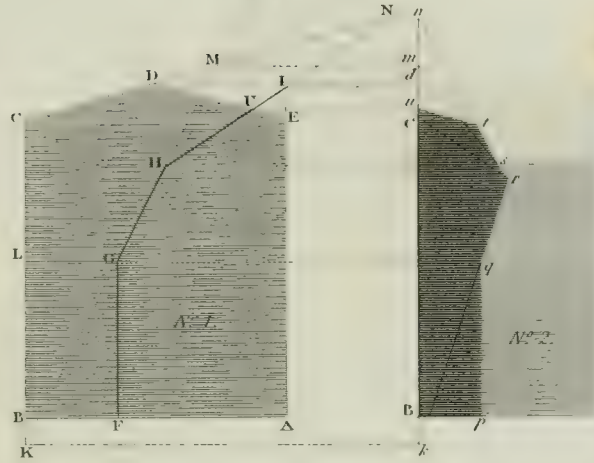

Fig. 3.

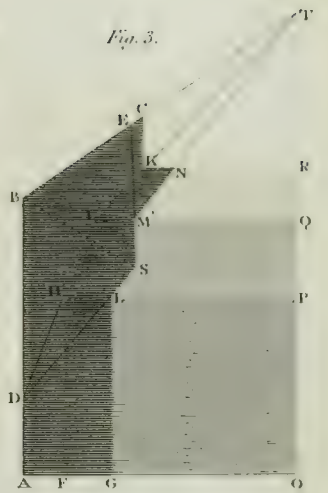

Fig. 4.

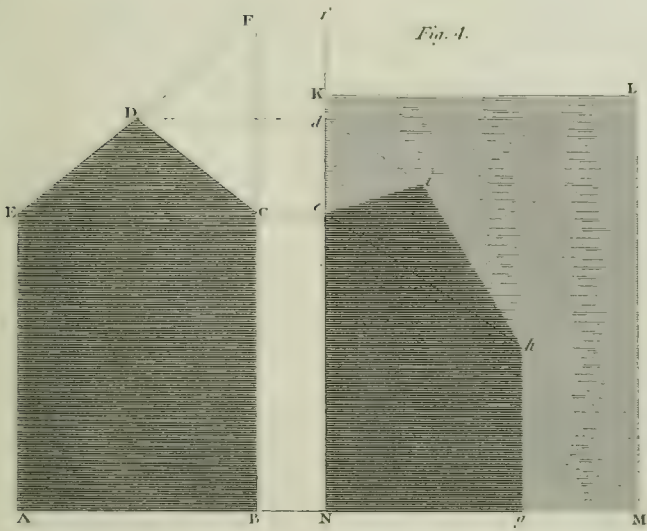

Fig. 5.

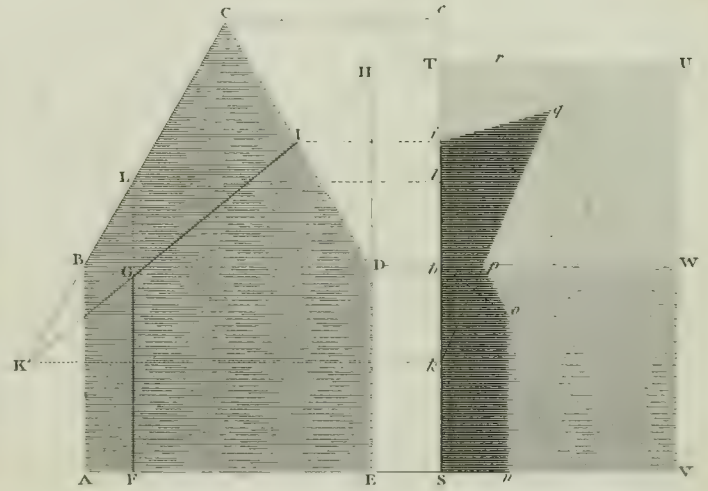

Fig. 6. N° 1.

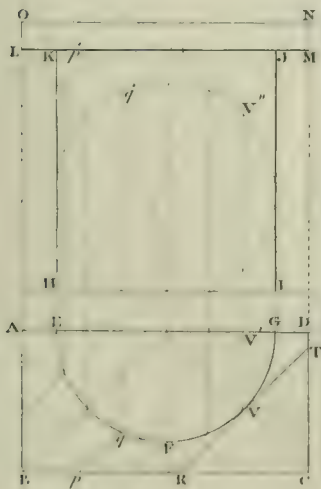

Fig. 6. N° 2.

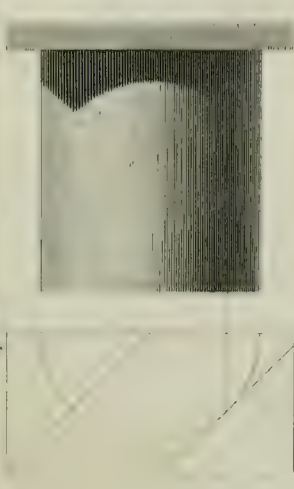

Fig. 7. N° 1.

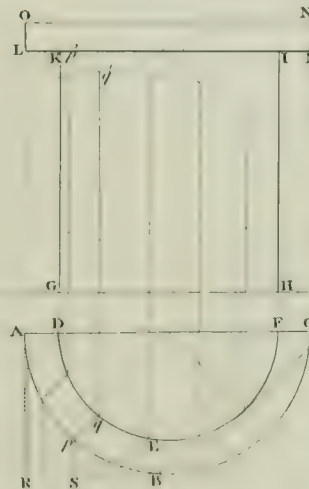

Fig. 7. N° 2.

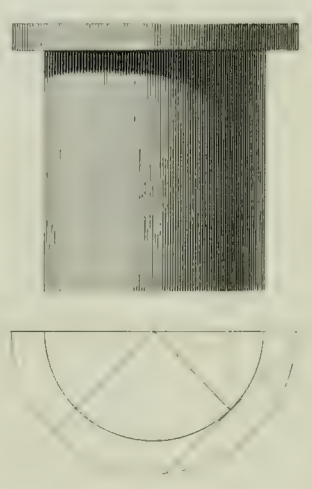

Fig. 1.

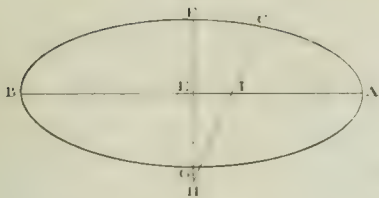

Fig. 1.

S

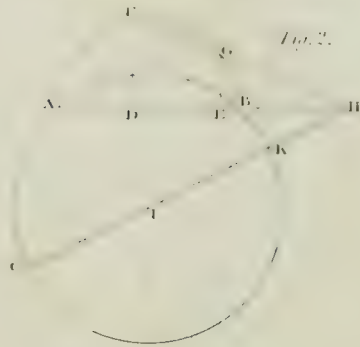

Fig. 2.

Fig. 3.

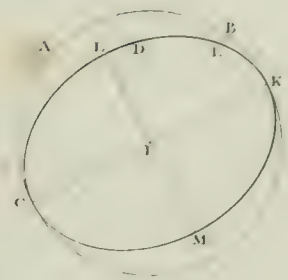

Fig. 5.

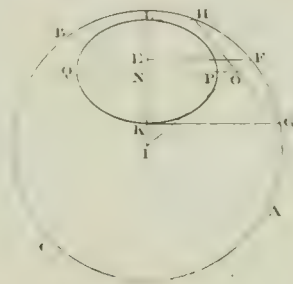

Fig. 6.

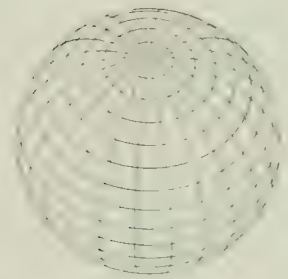

Fig. 9.



Fig. 7.

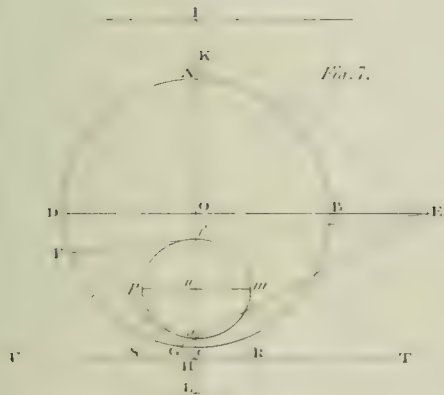

Fig. 8.

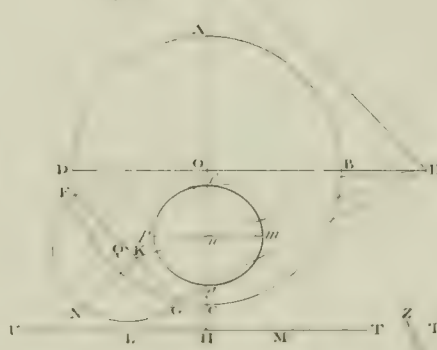

Fig. 10.

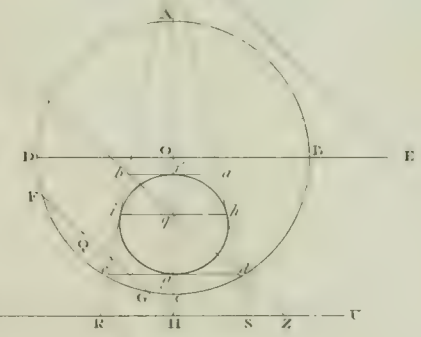

Fig. 11.

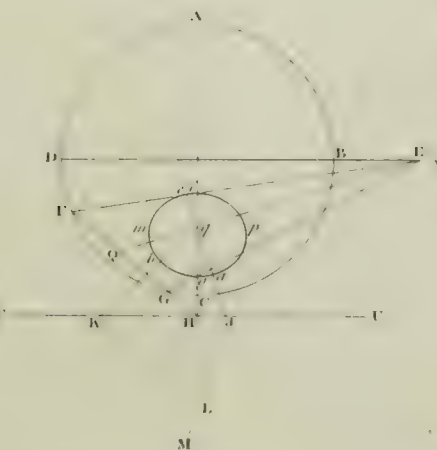

Fig. 12.

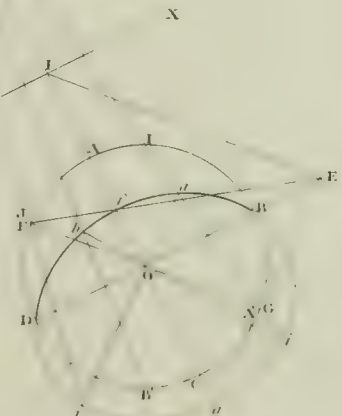

Fig. 10.

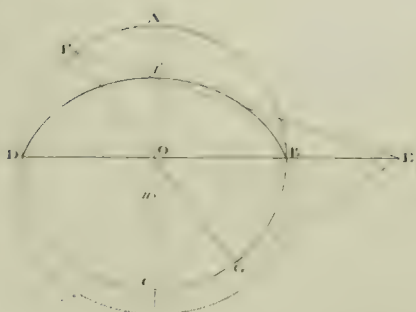

Fig. 1.

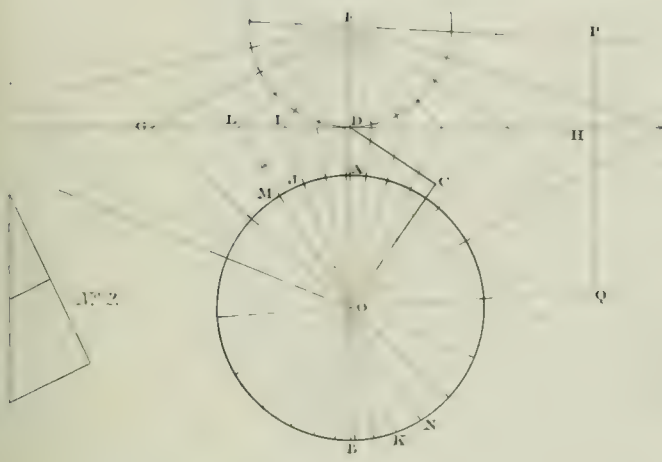

Fig. 2.

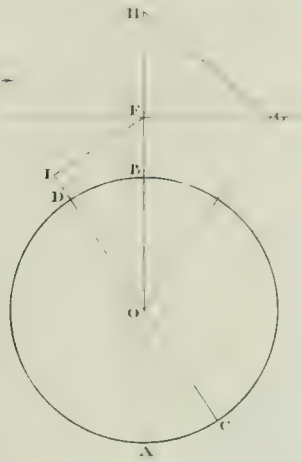

Fig. 3.

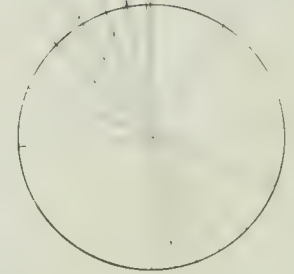

Fig. 4.

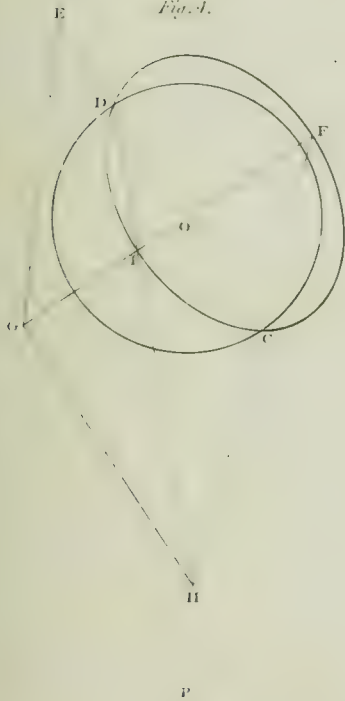

Fig. 5.

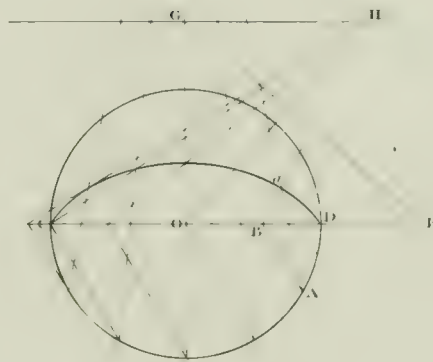

Fig. 6.

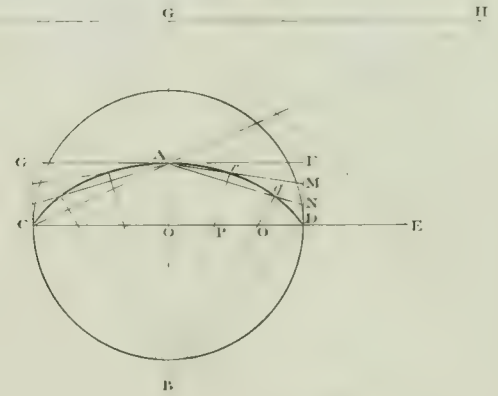

Fig. 7.

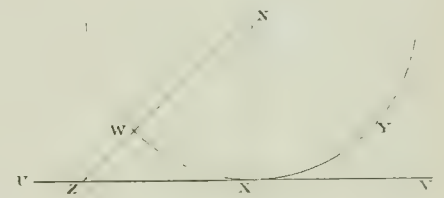

Fig. 8.

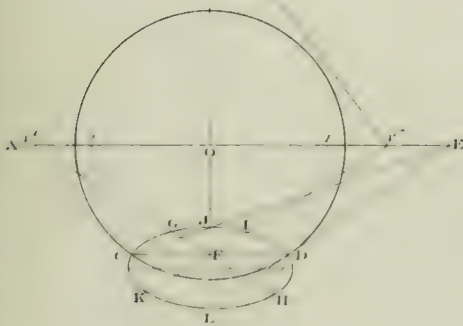
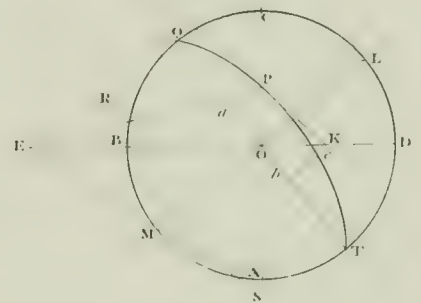
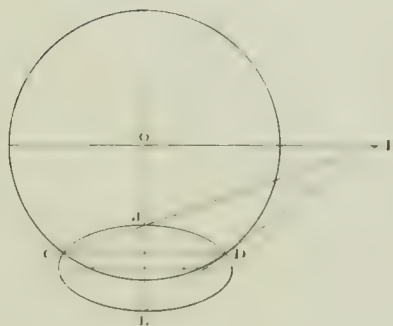

Fig. 9.



Brook Taylor's principles of perspective first applied to the projection of the sphere by P. Nicholson.

Fig. 1.

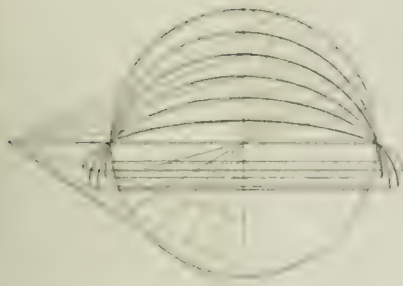

Fig. 2.

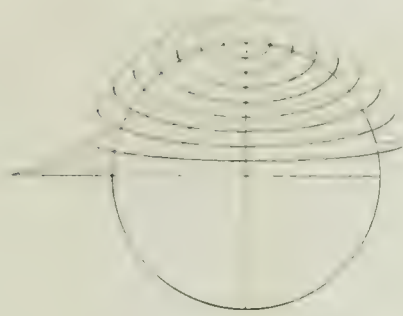

Fig. 3.

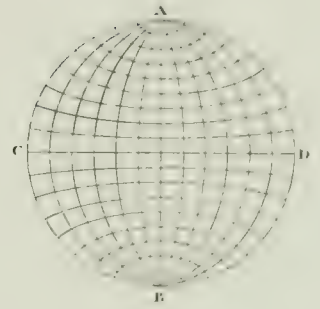

Fig. 4.

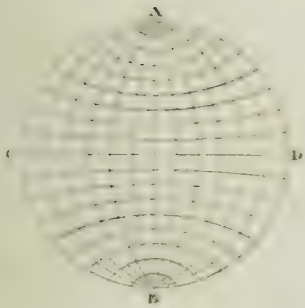

Fig. 5.

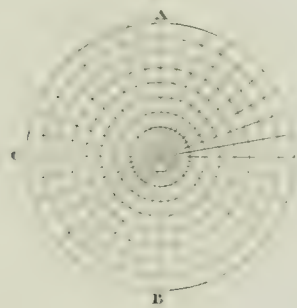

Fig. 6.

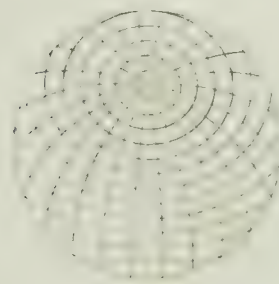

Fig. 10.



Fig. 7.

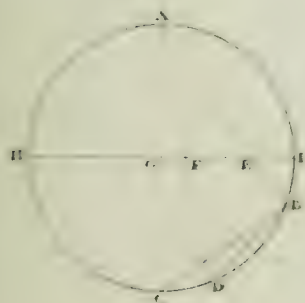

Fig. 8.

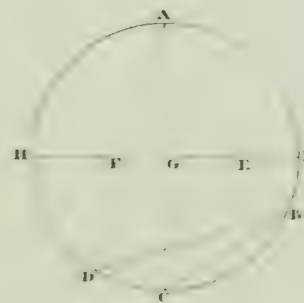

Fig. 9.

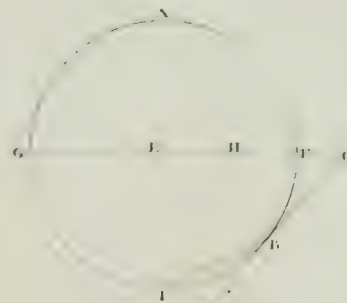

Fig. 11.

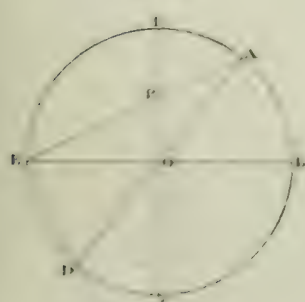

Fig. 12.

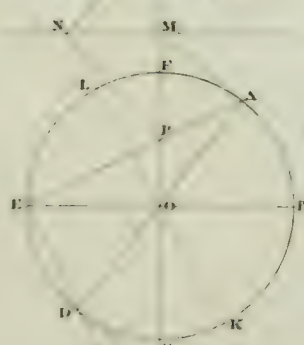

Fig. 13.

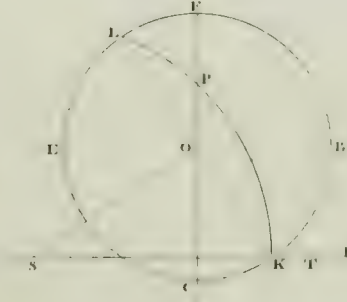
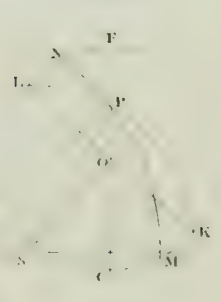
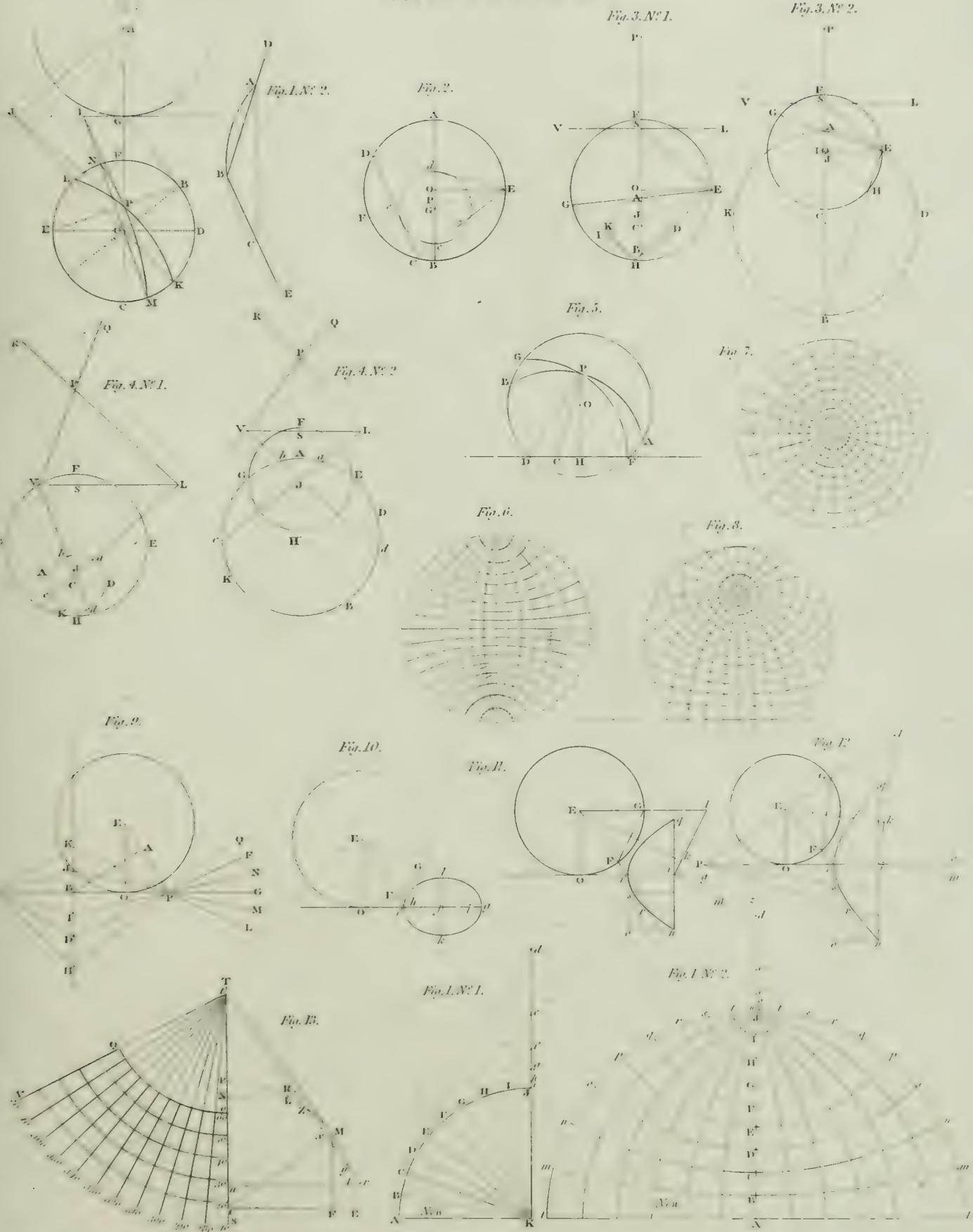

Fig. 14.



PROJECTION.



PROPORTIONAL COMPASSES.

Fig. 1.

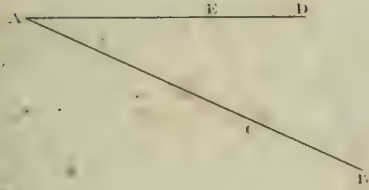

Fig. 2.

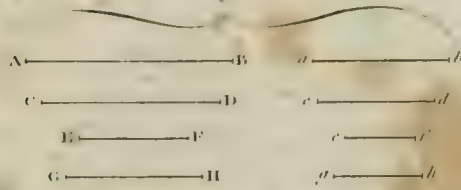

Fig. 3.

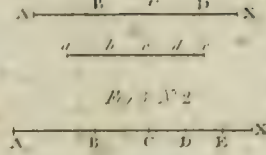

Fig. 7.

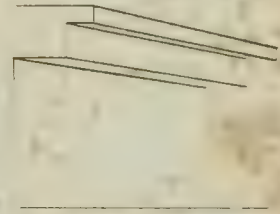

Fig. 4.

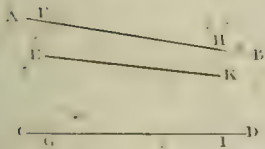

Fig. 5.

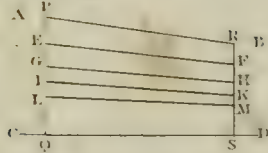

Fig. 6.

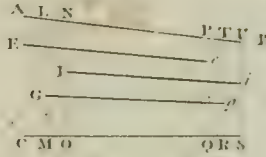

Fig. 12.

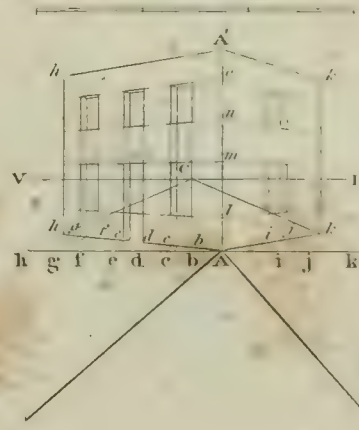

Fig. 13.

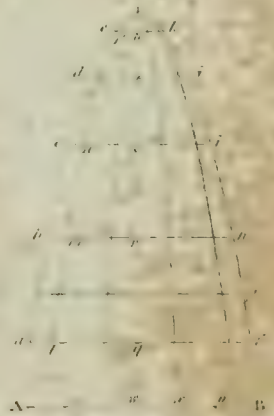

Fig. 8.

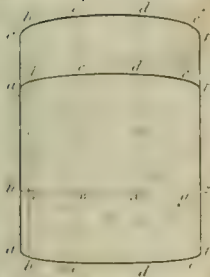

Fig. 9.

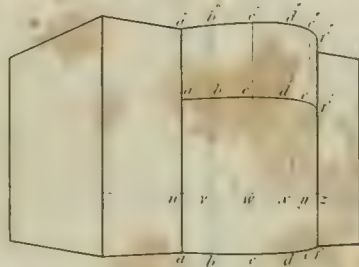

Fig. 14.

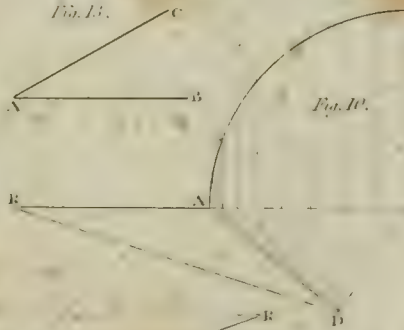

Fig. 10.

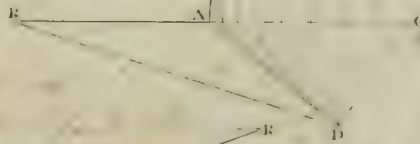

Fig. 11.

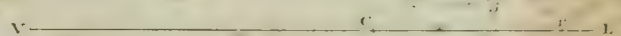

Fig. 11.

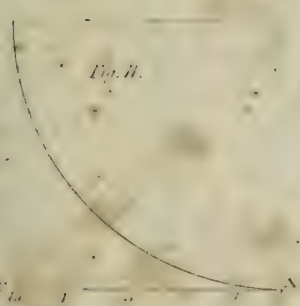

Fig. 16.

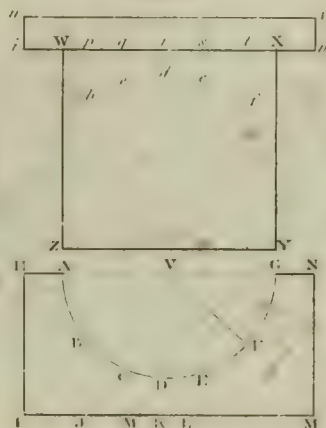

Fig. 17. No. 1.



Fig. 17.

No. 1.

a.
b.
c.
d.
e.
f.
g.
h.
i.
j.
k.
l.
m.
n.
o.
p.
q.
r.
s.
t.
u.
v.
w.
x.
y.
z.



PYROTECHNY

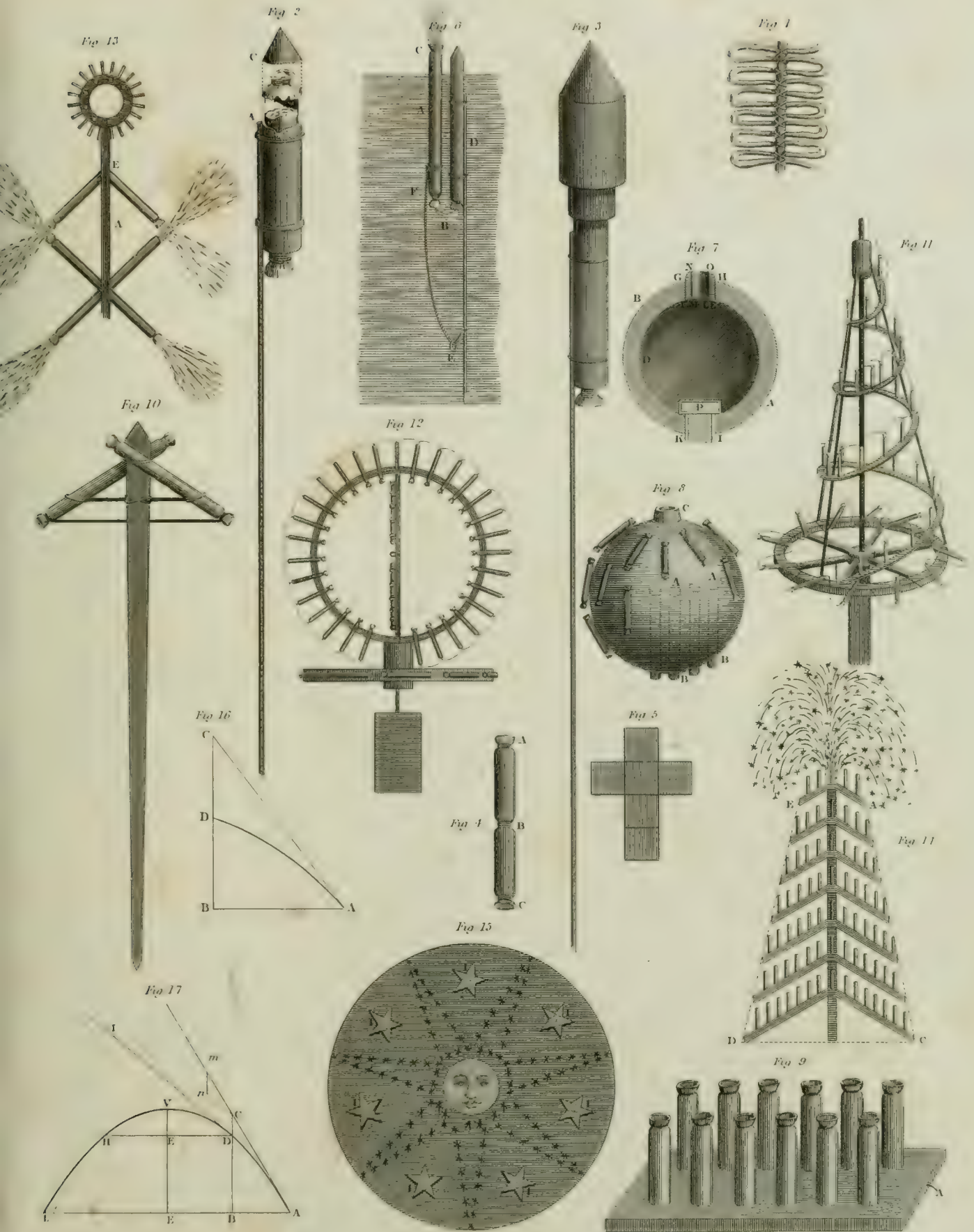

Fig. 1.

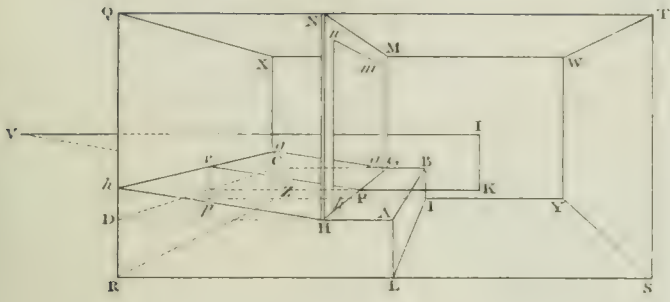

Fig. 2.

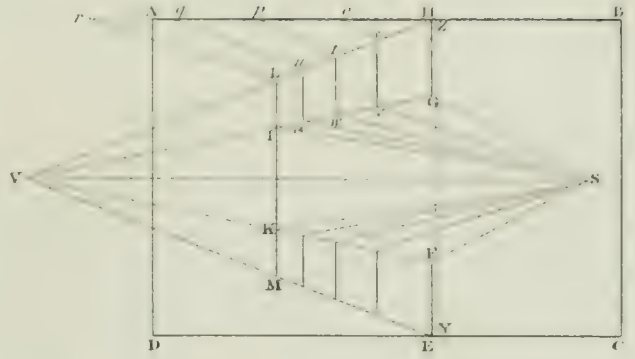

Fig. 5.

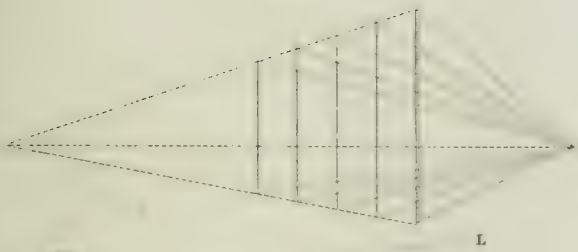

Fig. 3.

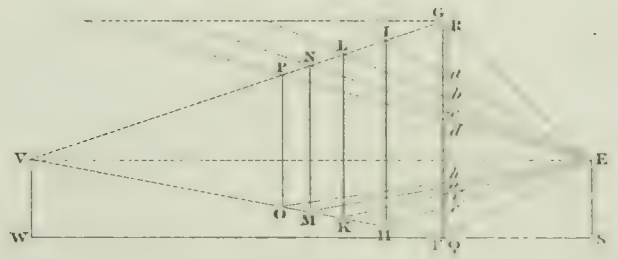

Fig. 8.

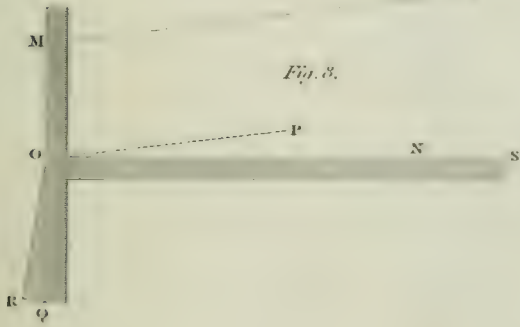

Fig. 6.

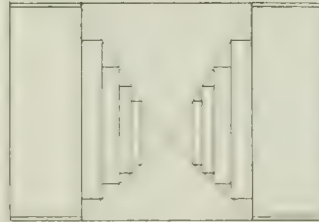

Fig. 4.

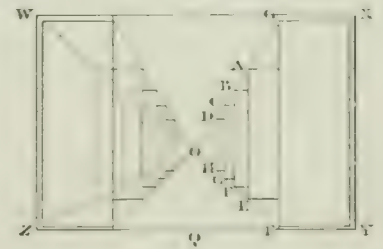

Fig. 9.

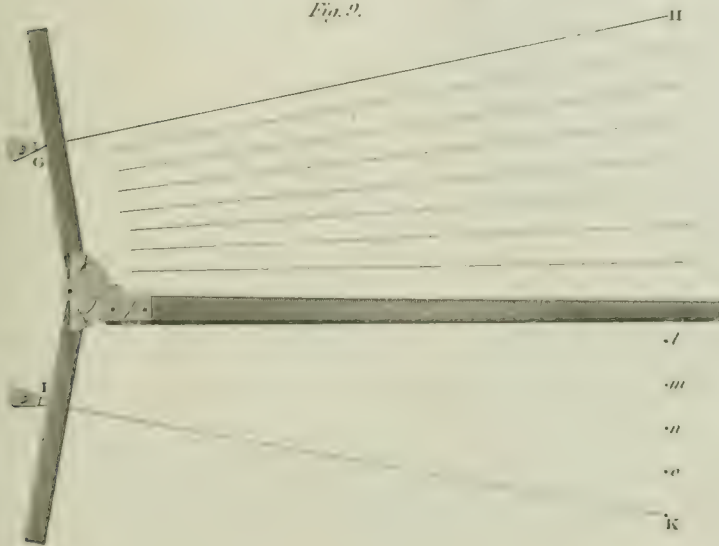

Fig. 10.

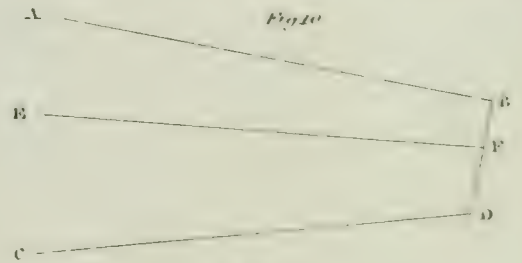

Fig. 7.





Drawn by H. Howard.

Engraved by R.R. Cooper.

FROM AN ANTIQUE MARBLE GROUP OF CUPID & PSYCHE, IN THE CAPITOL.

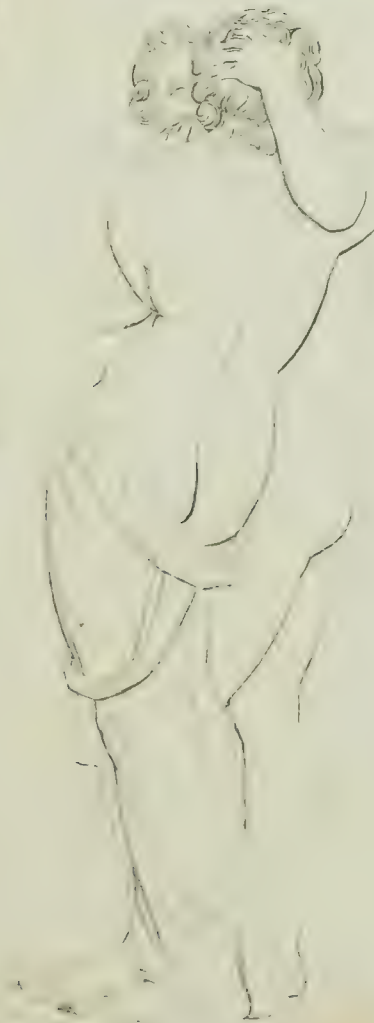

THE GROUP OF CUPID & PSYCHE SEEN IN DIFFERENT VIEWS
STATUES.

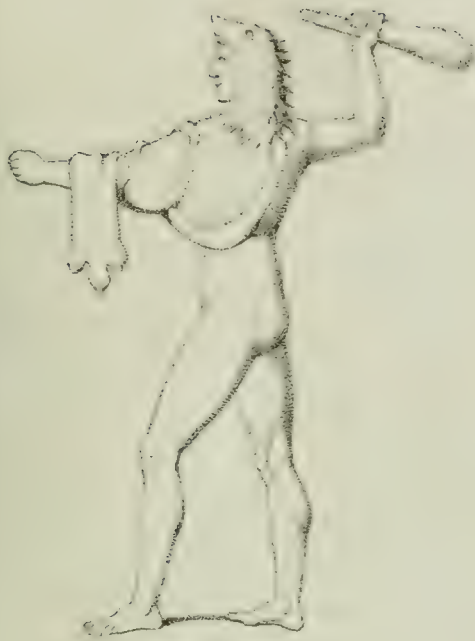

*Hercules of Dodona,
from a small bronze.*

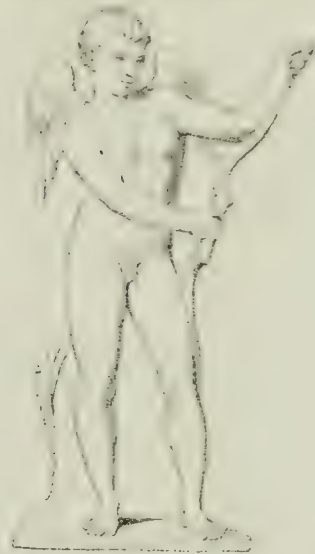

*Cupid of Praxiteles,
British Museum &c.*



*Minerva of Dipronus & Scyllis,
in the Villa Albani.*

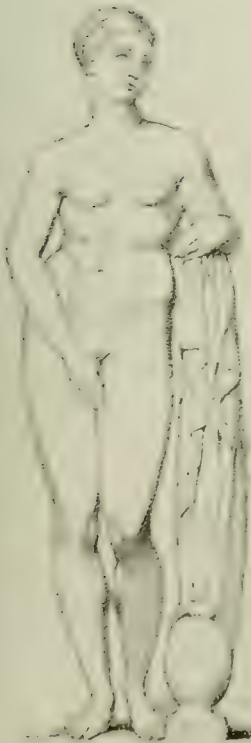

*Venus of Praxiteles,
Perriers Statues.*



*Jupiter Olympius. See Pausanias, Ancient
Statues, Coins & Gems.*

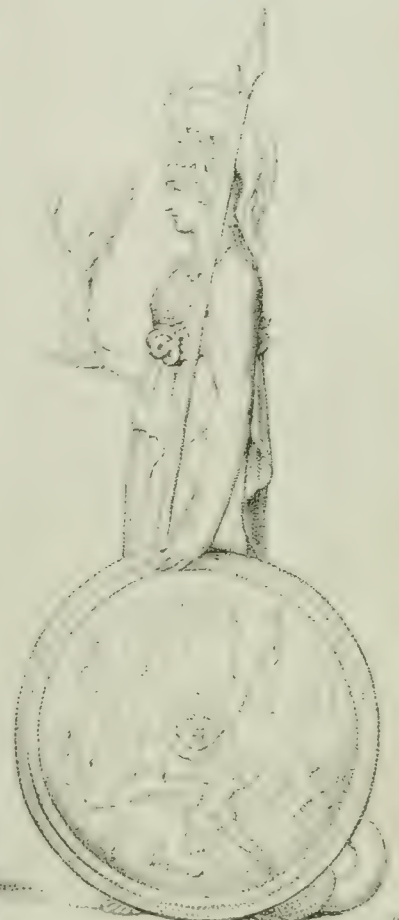

*Minerva of the Acropolis in Athens.
See Hunter's Coins.*

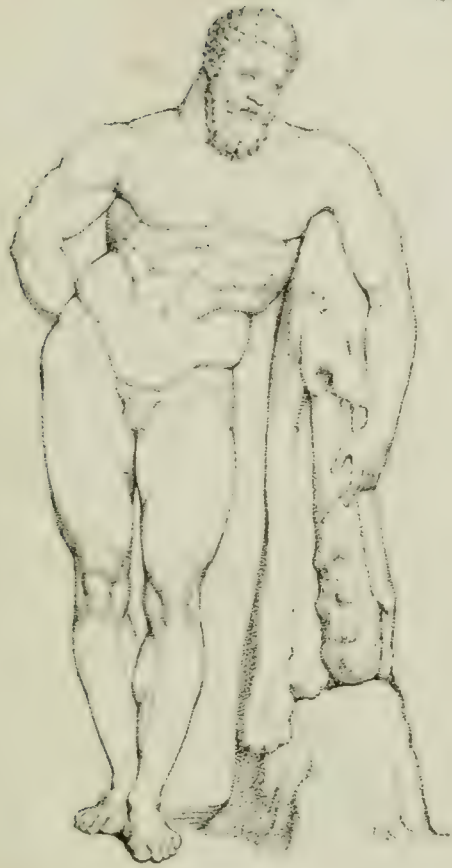

Herculis Farnese

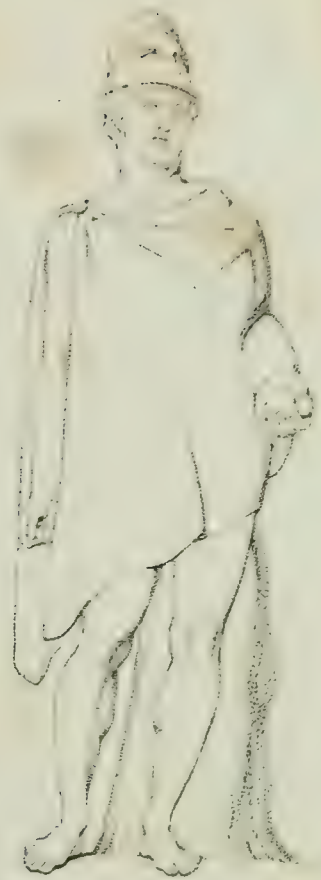

Phocion



Dirce

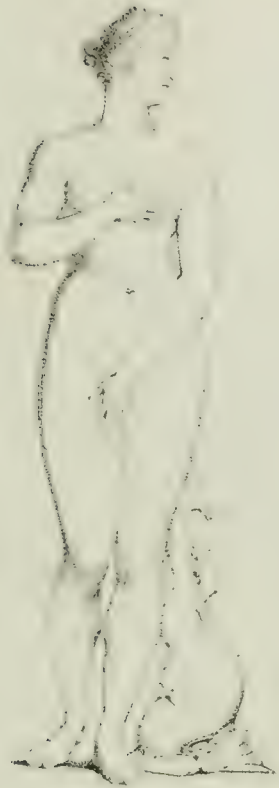

Venus de Medici

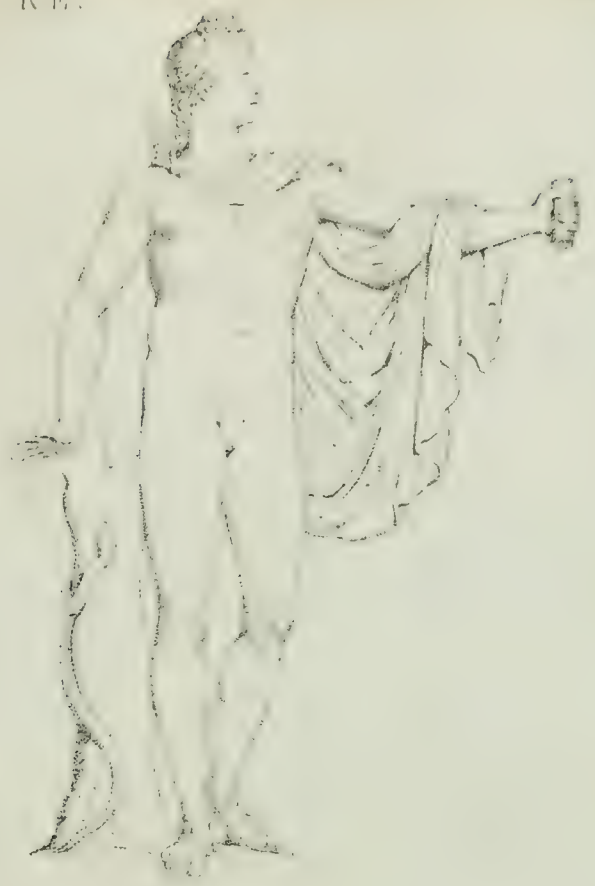

Apollo Belvedere



Laocöon



Durgā Slaying Mahishasura, a Hindu group.



An Etruscan Fatera, in the British Museum.



A Colossal Statue, at Thebes.



Persian Sculpture, at Persepolis.

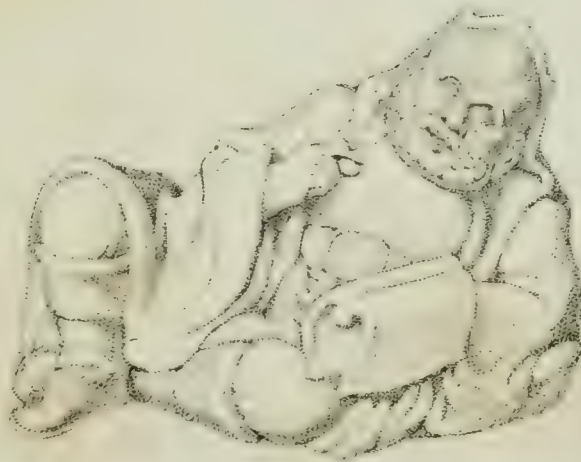

A Chinese Statue.

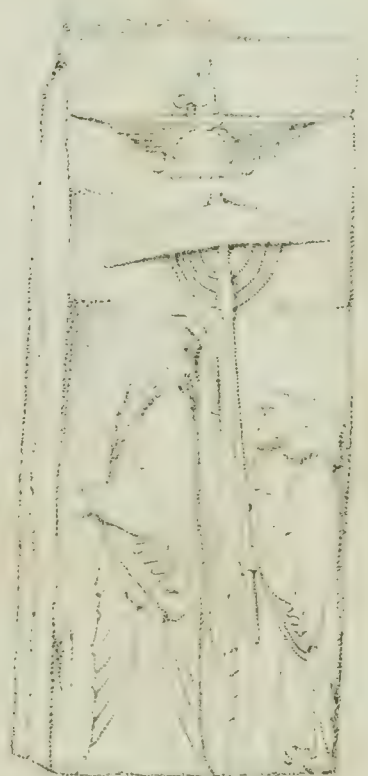

Persian Sculpture, at Persepolis.

Fig. 5

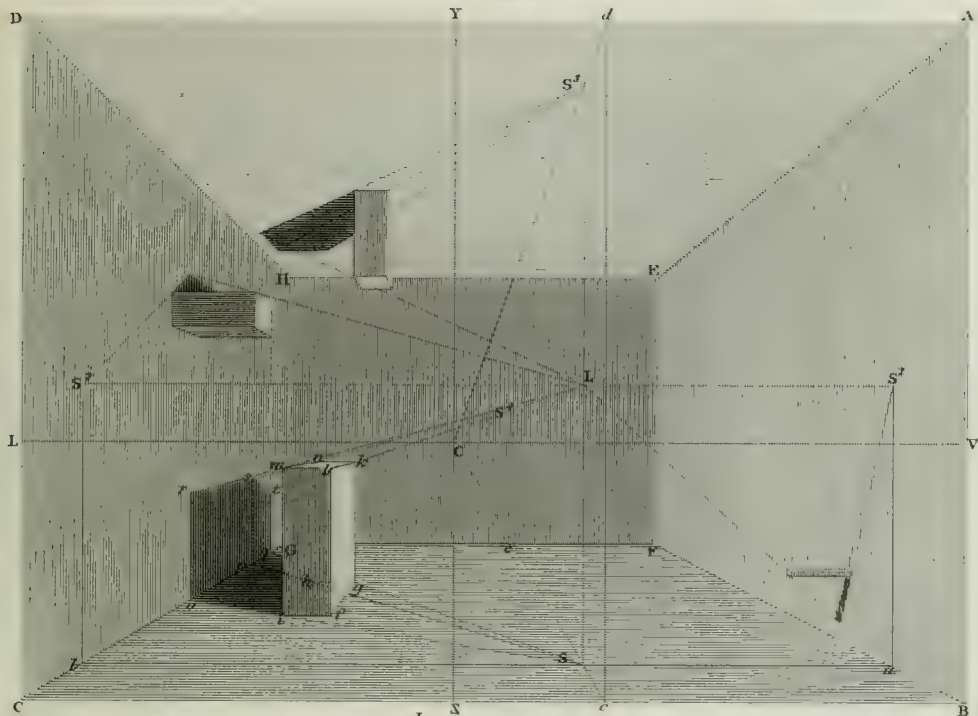

Fig. 1.

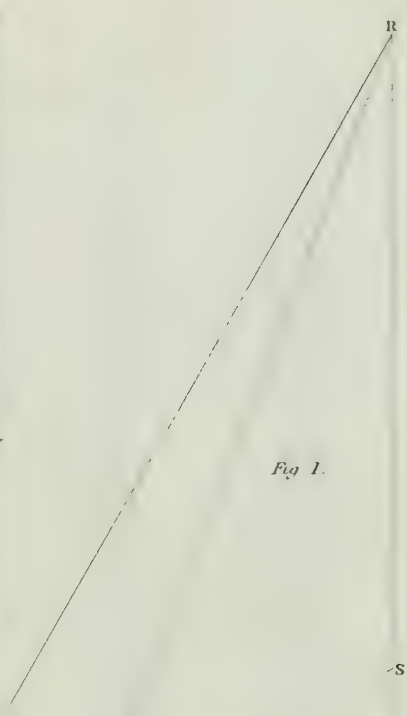

Fig. 3.

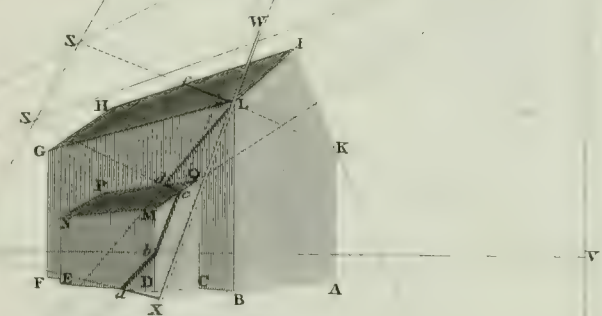
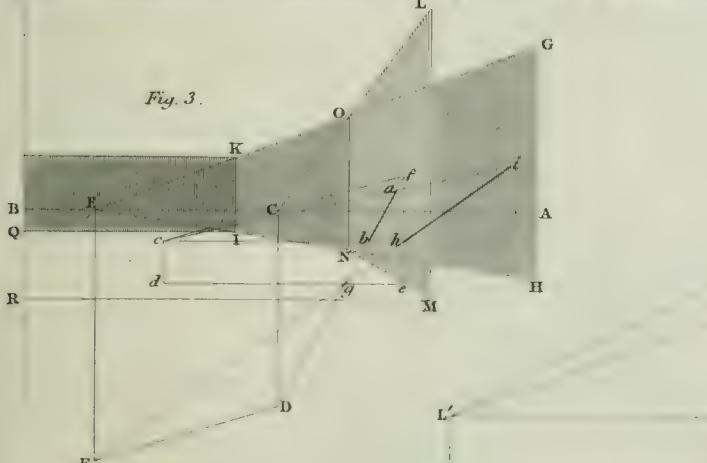

Fig. 4.

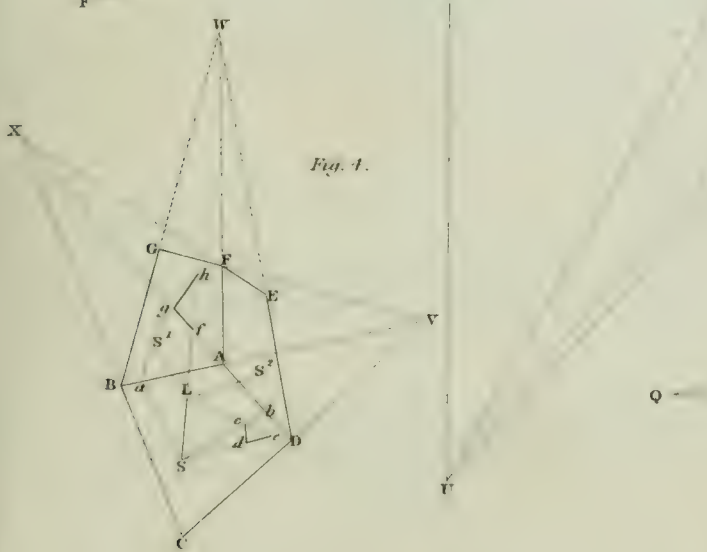
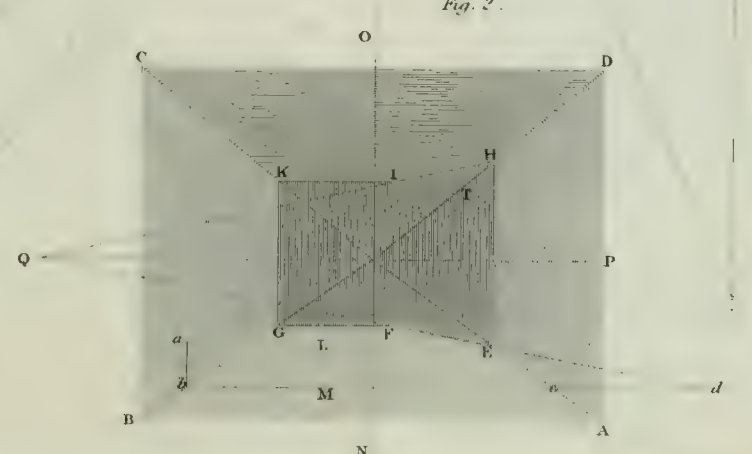
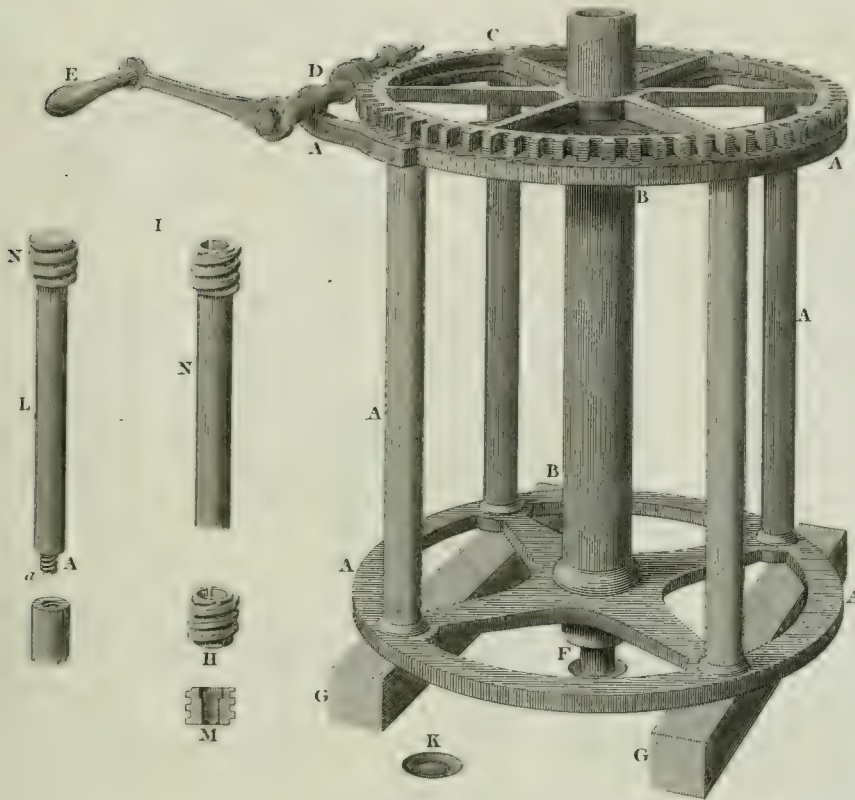

Fig. 2.



Capt. Bolton's machine for drawing Bolts.

Fig. 1.



Phillips's tubes for driving bolts.

Fig. 3.

Fig. 2.

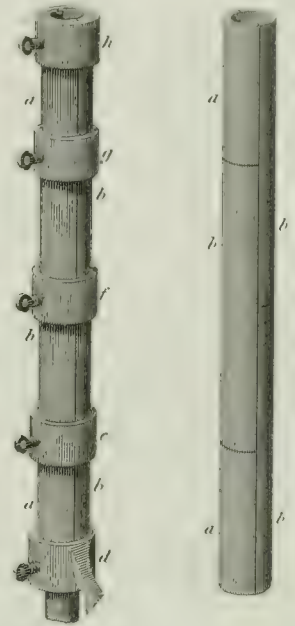

*Fig. 4.
Ring Rope*

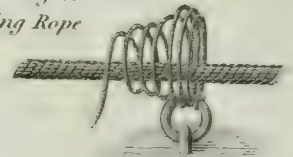

*Fig. 5.
Bits.*

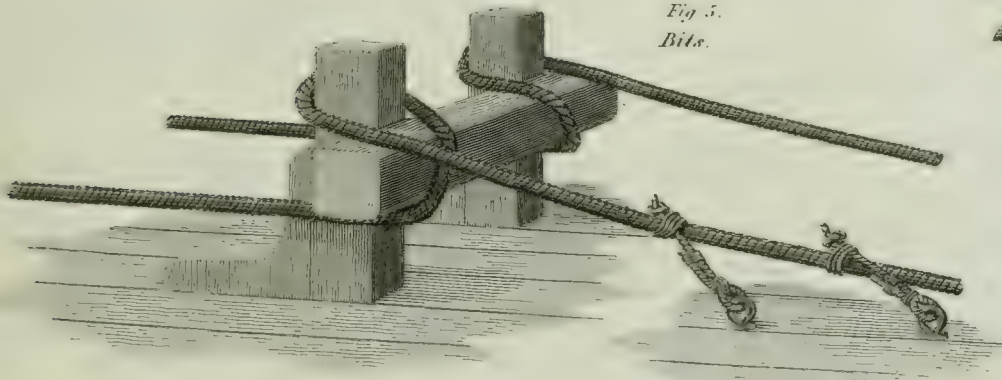

*Fig. 5.
Application of the Messenger.*

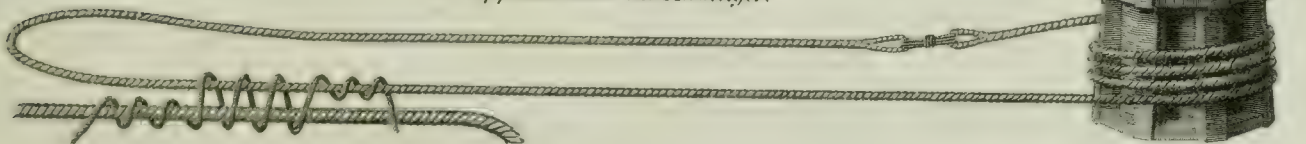

Fig 7

Nippers.

Fig. 6.

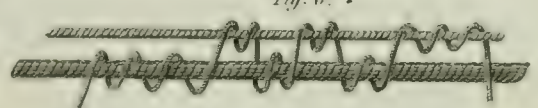
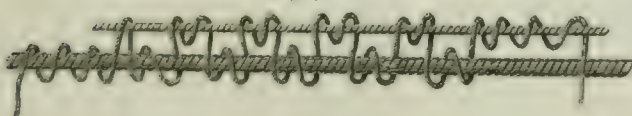

Fig. 1

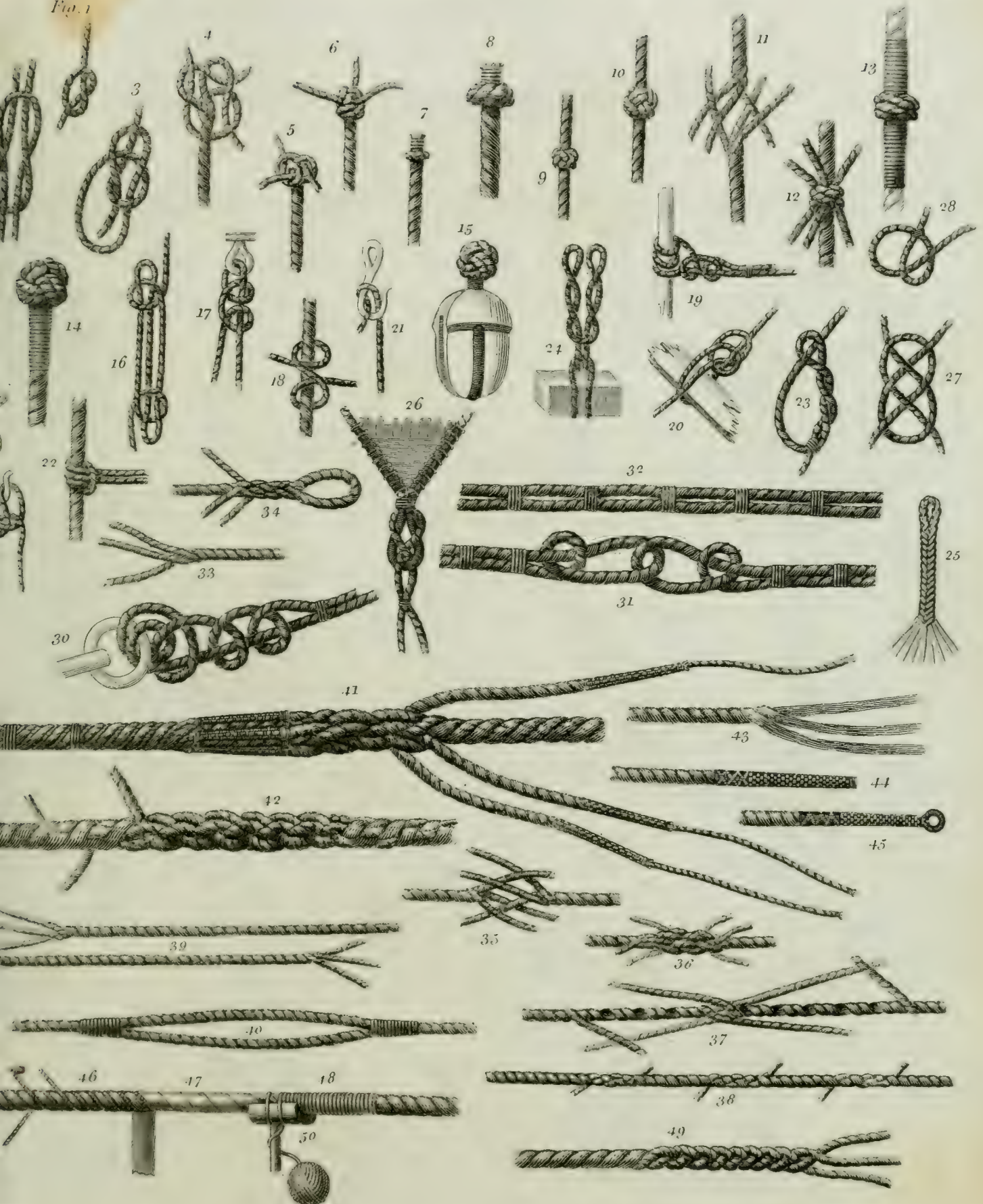

Fig. 10

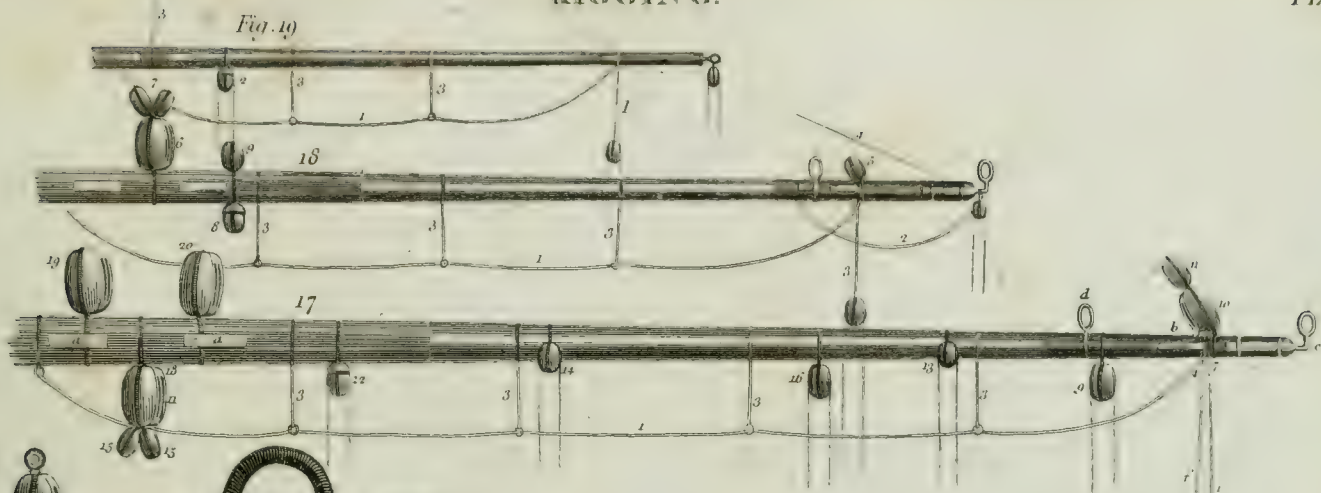

Fig. 1

Bale Slings

Butt Slings

Can Hook Slings

SHIPS.

FIG. 1.



Fig 2.



Fig 1.



Fig 2.

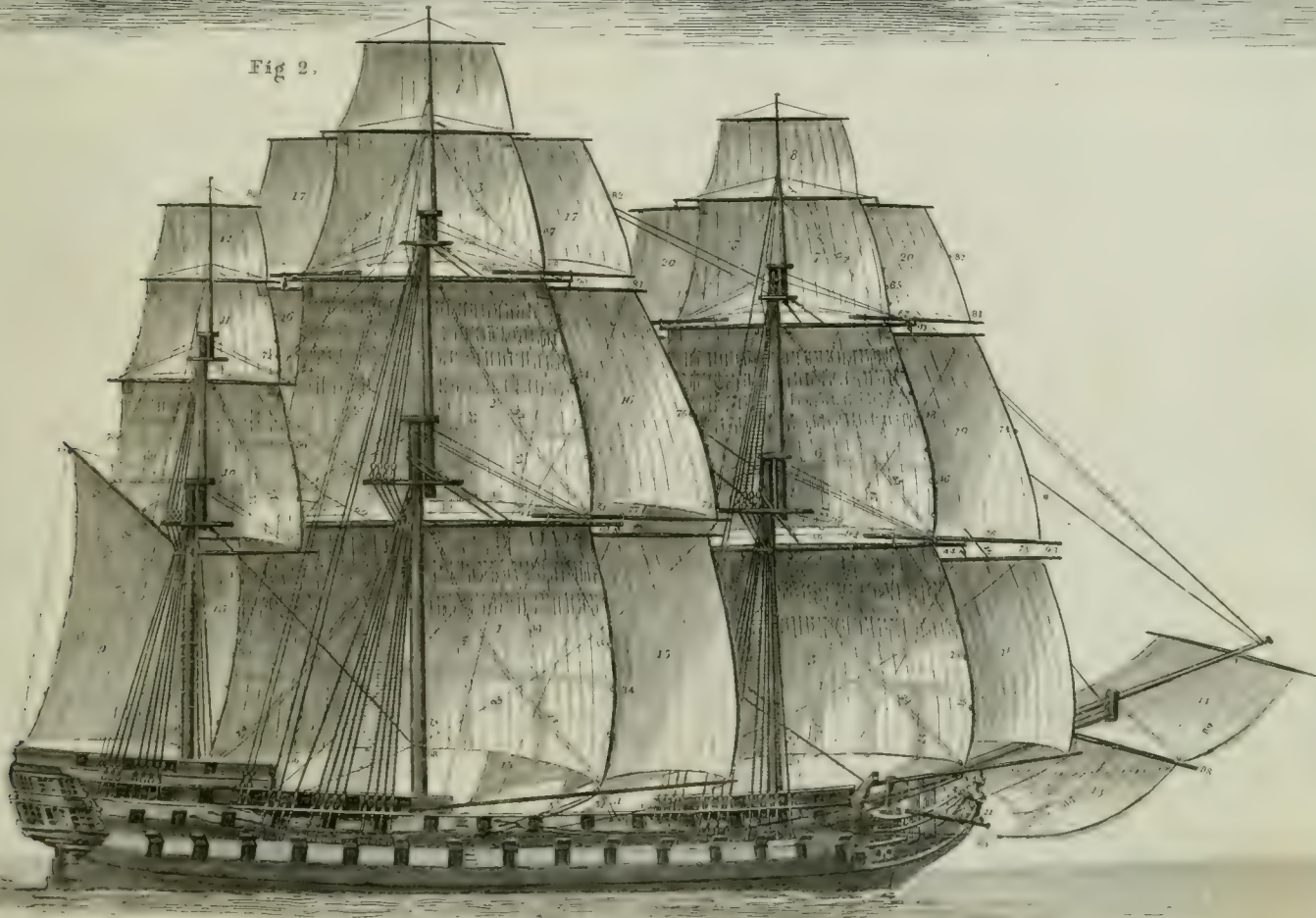

British Men of War.



First Rate.

Man of War's Barge.

Seventy four.

Lugger.



Fire Brig.

Flat Bottomed Boat.

Gun Vessel (*the Wolverine.*)

Man of War's Long Boat.



Pahie

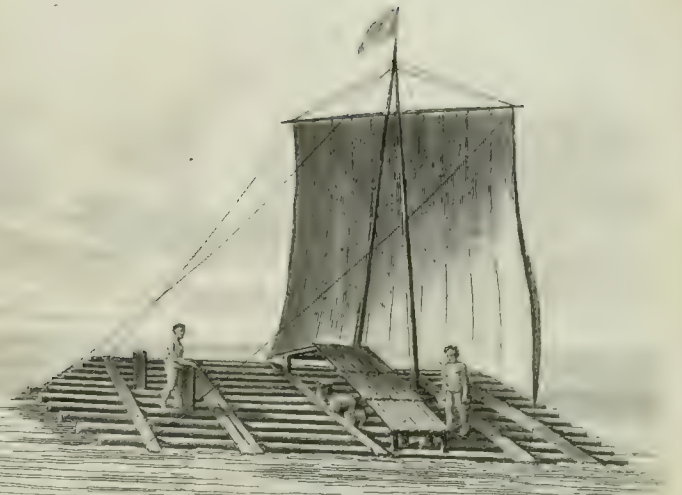

Balza

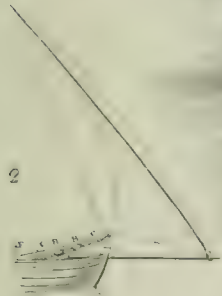

Life Boat

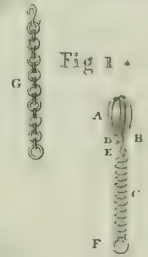
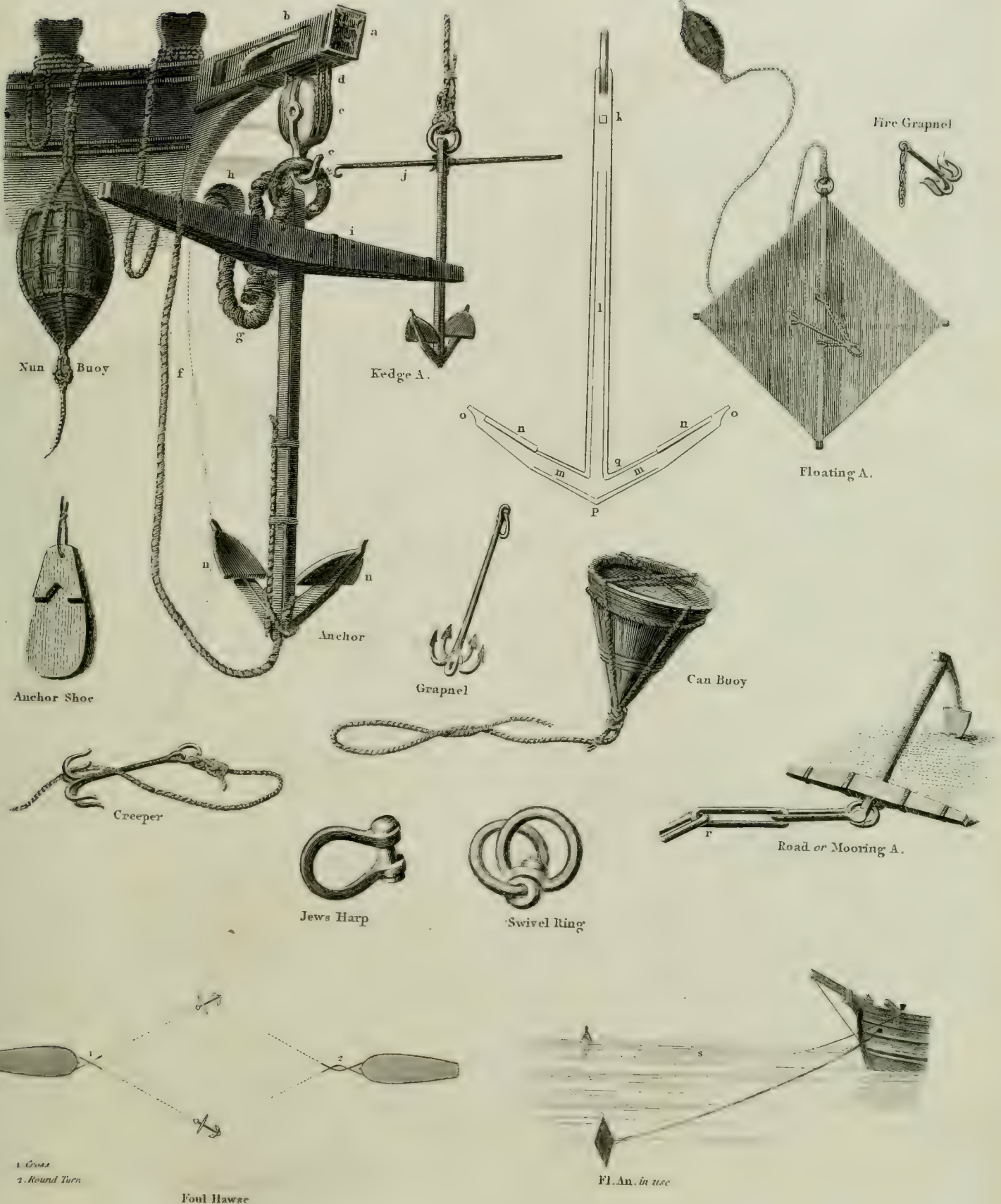

Fig 1.



Caracore

* Spring Block



a. Cat Head. b. Clot. c. Cat Block. d. Cat-Fall. e. Cat-Hook. f. Buoy Rope. g. Hawsers. h. Hawsse Hole. i. Stock. j. Shilling Stock (Iron). k. Nut for securing the Stock. l. Shank. m. Arms. n. Flukes. o. Bill. p. Crown. q. Throat. r. Mooring Chain. s. Buoy Guy.

Published as the Act directs, July 2, 1860, by Lowman, Huest, Ross & Co., Printers, New York.

SHORT HAND.

*The Alphabet
Invented by John Byrom, M.A. and F.R.S.*

LETTERS.	WORDS.	PREPOSITIONS.	TERMINATIONS.	Miscellaneous EXAMPLES.	
A	----- <i>A</i>	-----	-----	∩ Answer	
b)) <i>be; but</i>	Be-	-able	∩ Cypher	
c, e	-, e (s. or k.)	-----	-----	∩ Departure	
d	(<i>and</i>	de-	-ed	∩ Entertained	
e	-----	-----	-----	∩ Fail	
f	\ <i>of</i>	for-	{-ful	∩ Feel	
g	e { <i>again</i> <i>against</i>	-----	-----	∩ Forward	
h	9 d <i>have; had</i>	-----	-----	∩ Library	
i	----- <i>I</i>	-----	-----	∩ Matrimony	
k	e { <i>can</i> <i>could</i>	{ com- con-	-ical	∩ Nations	
l	6 p r <i>all; always; altogether</i>	-----	-----	∩ Numeration	
m) { <i>am</i> <i>amongst</i>	{ magni- mis- omni-	-ment	∩ Overcome	
n) { <i>an</i> <i>in</i> <i>under</i>	{ ante- or anti- in- or inter- in- or under-	{ -ence -ent -ness	∩ Perplex	
o	----- <i>O!</i>	-----	-----	∩ Revengeful	
p) <i>upon</i>	per- pre- or pro-	-----	∩ Short-hand	
q	9 <i>question</i>	-----	-----	∩ Square	
r	/ <i>or</i>	re-	-ary 'ing	∩ Substance	
s	- { <i>as</i> <i>is</i> <i>us</i>	{ satis- circum- sub- or super-	{ -ation -ition -ition -ition	{ -self -never	
t	<i>the</i>	trans-	-ity	Common CONTRACTIONS.	
u	----- <i>you</i>	-----	-----	Dr. ∩ Doctor	
v	\	-----	-----	Etc. † Et cetera	
w	p d <i>will; would</i>	with-	-ward	Mr. ∩ Master	
x	✓ 9 <i>except; exercise</i>	ex-; extra-	-----	Mrs. ∩ Mistress	
y	9 <i>yet</i>	-----	-----	MS. ∩ Manuscript	
z	-	-----	-----	NB. ∩ Nota Bene	
ch	9 <i>which</i>	-----	-----	PS. 2. Postscript	
sh	e 6 <i>shall; should</i>	-----	-ship	Rev. ∩ Reverend	
th	(\ <i>that</i>	-----	-----	Viz. ∩ Videlicet	

Vowels' Places.

| | ab, et, &c.
| | tu, te, &c.
----- us, es, &c.
----- sa, se, &c.

(am, em, &c.
(ma, me, &c.
(an, en, &c.
(na, ne, &c.

Figures.

1
2
3
4
5
6
7
8
9
0

∩
|
/
\
)
-
(
(
)
/

SILK MANUFACTURE

Reeling. Fig. 1.

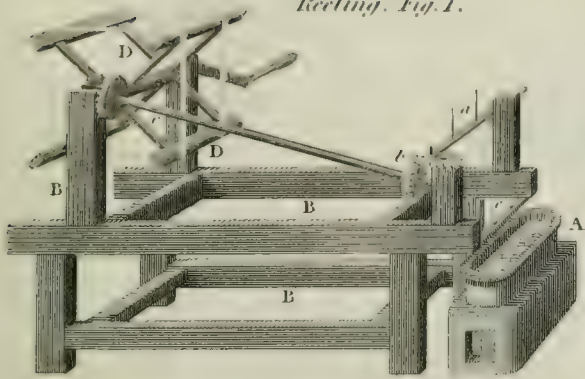

Winding. Fig. 2.

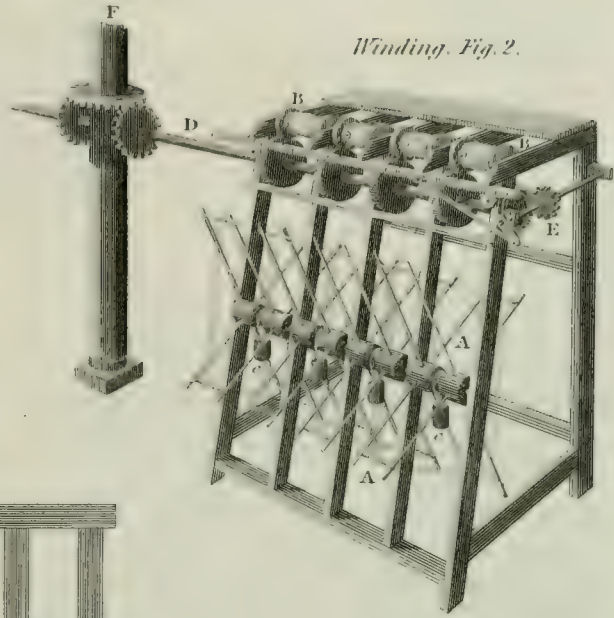

Throwing. Fig. 3.

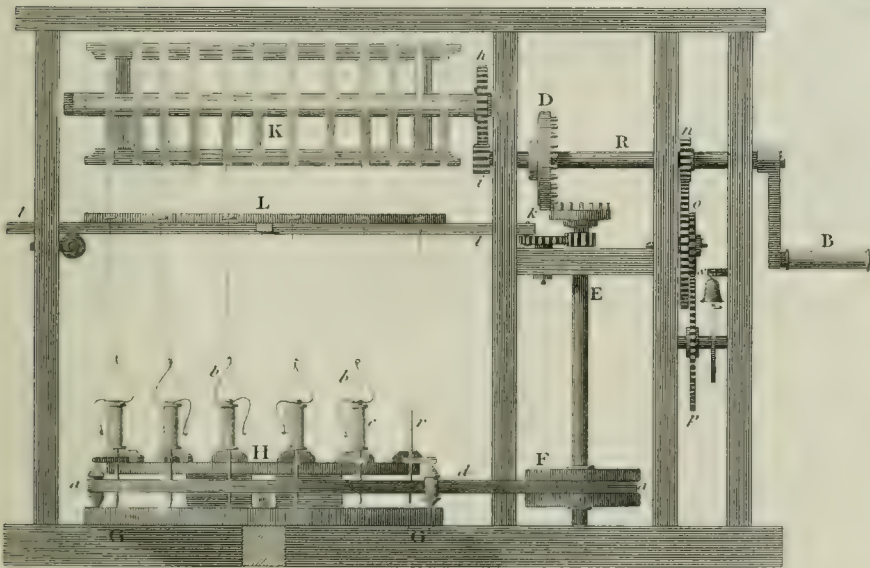

Doubling. Fig. 4.

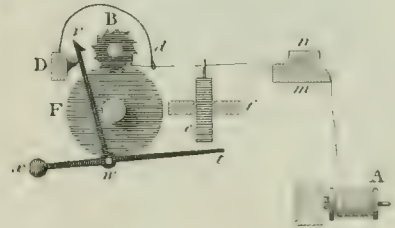

Warping. Fig. 6.

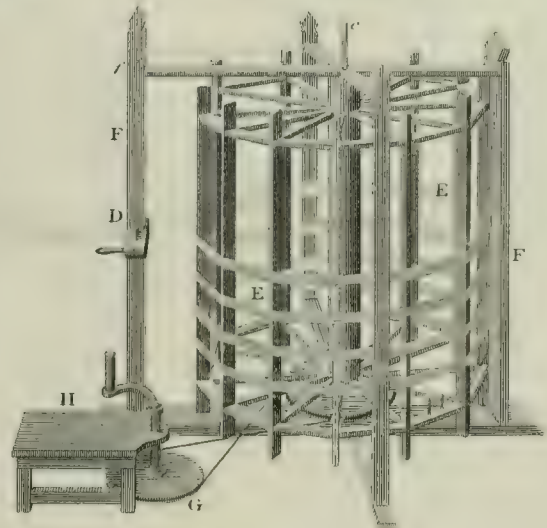
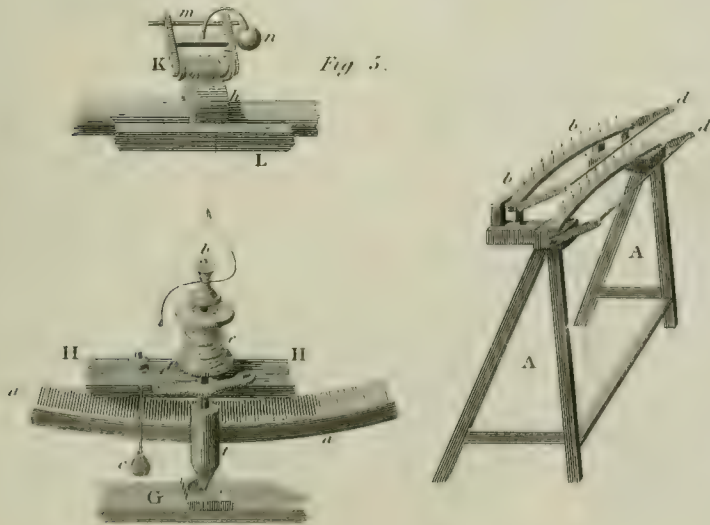
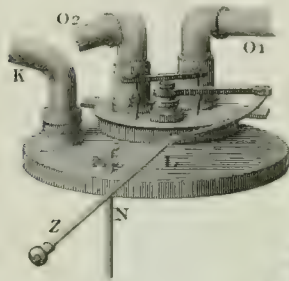
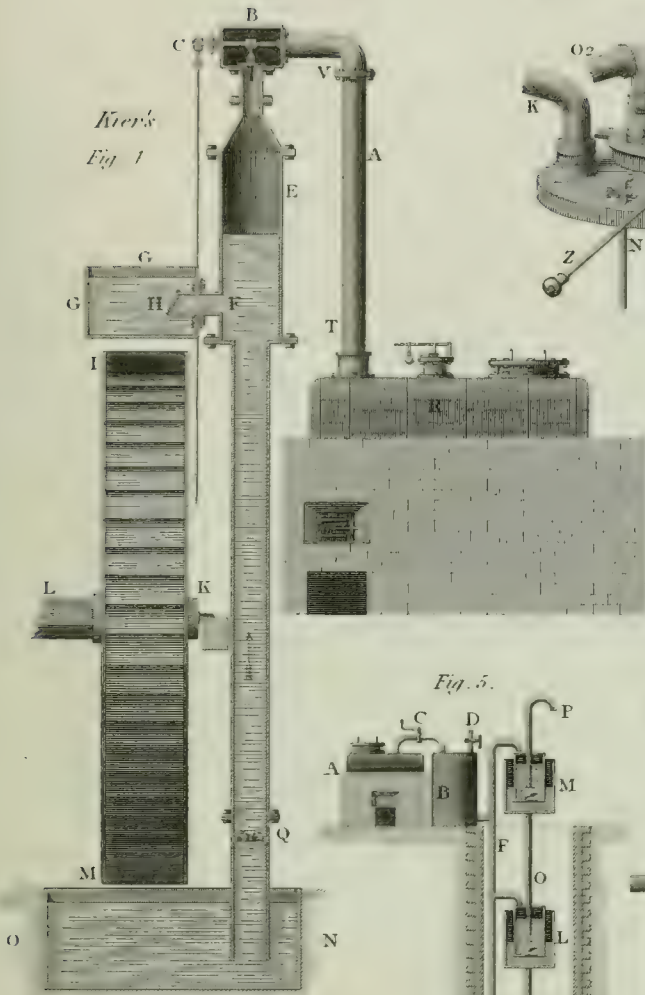

Fig. 5.



*Kier's
Fig. 1*



*Savery's
Steam Engine.
Fig. 1.*

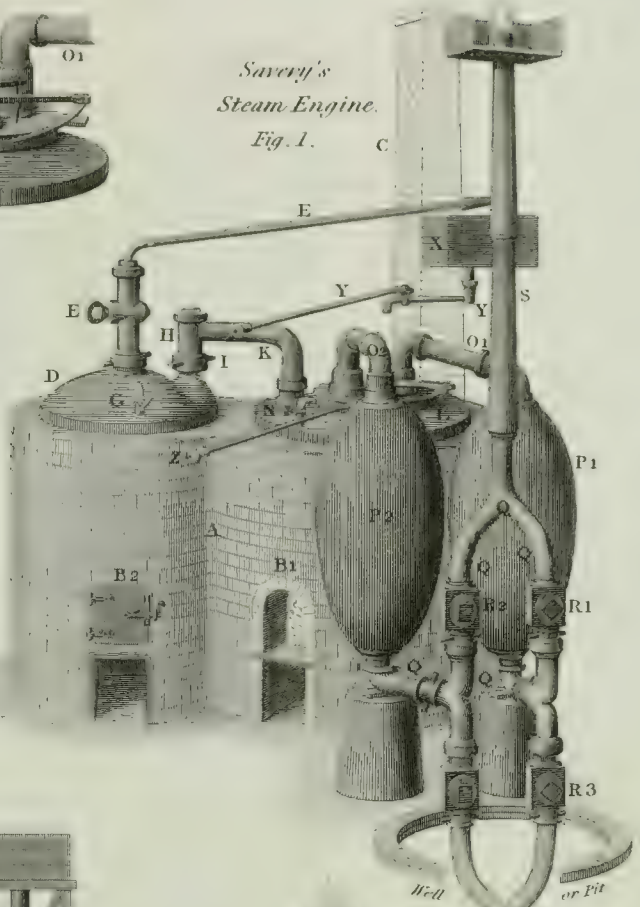
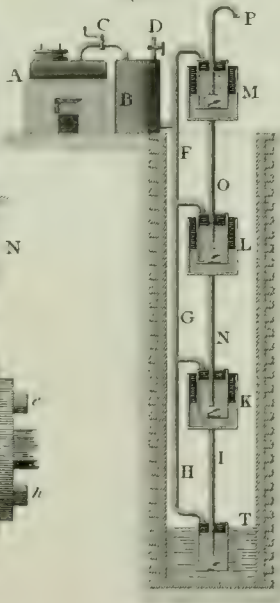

Fig. 5.



*Blakey's
Fig. 3.*

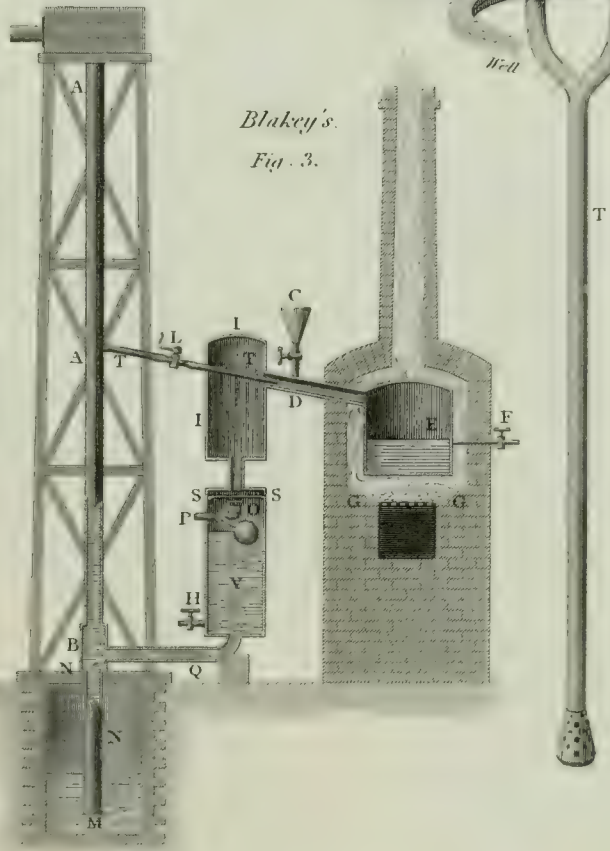
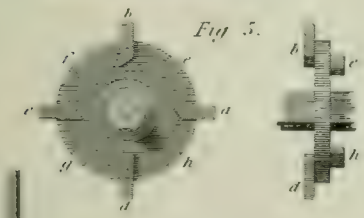
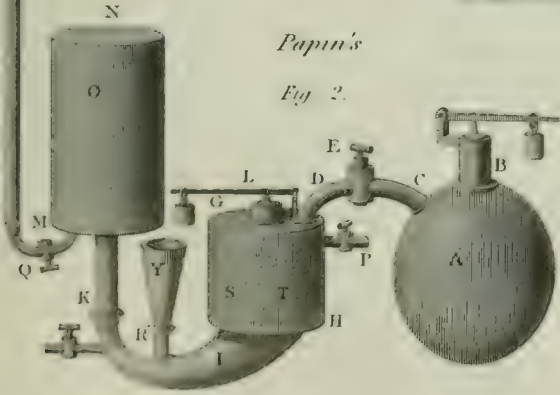

Fig. 5.



*Papin's
Fig. 2.*



Atmospheric Steam Engine.

Fig. 1.

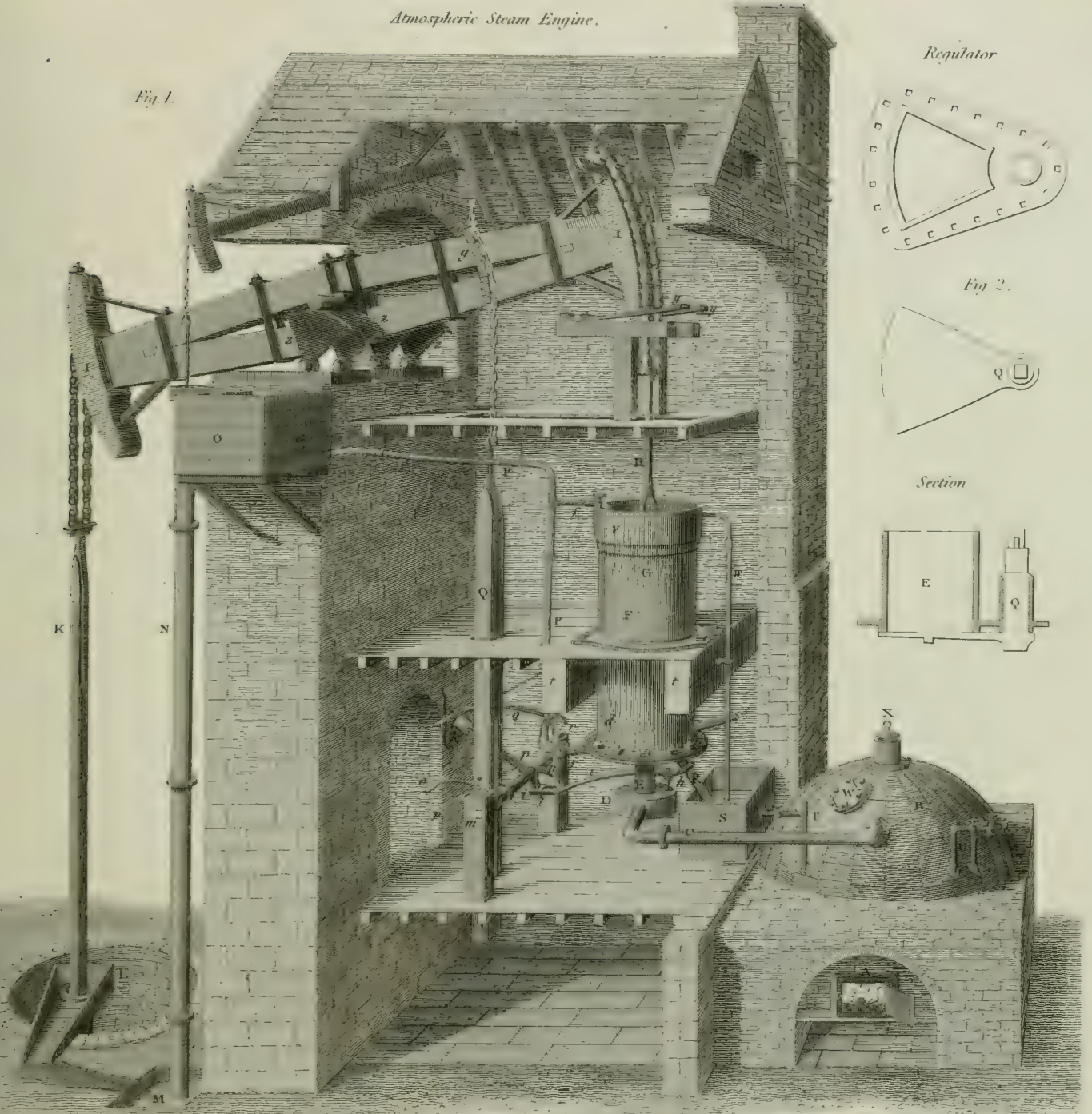

Regulator

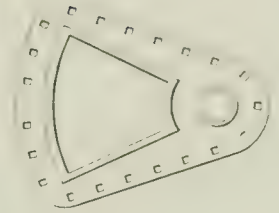
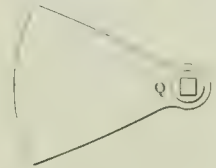

Fig. 2.



Section



Injection Cap.
by M. Smeaton

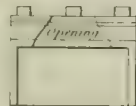

Piston

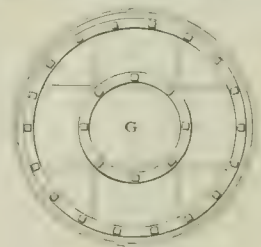
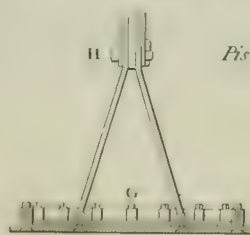

STEAM ENGINE.

On the principle of NEWCOMEN, as constructed by SMEATON.

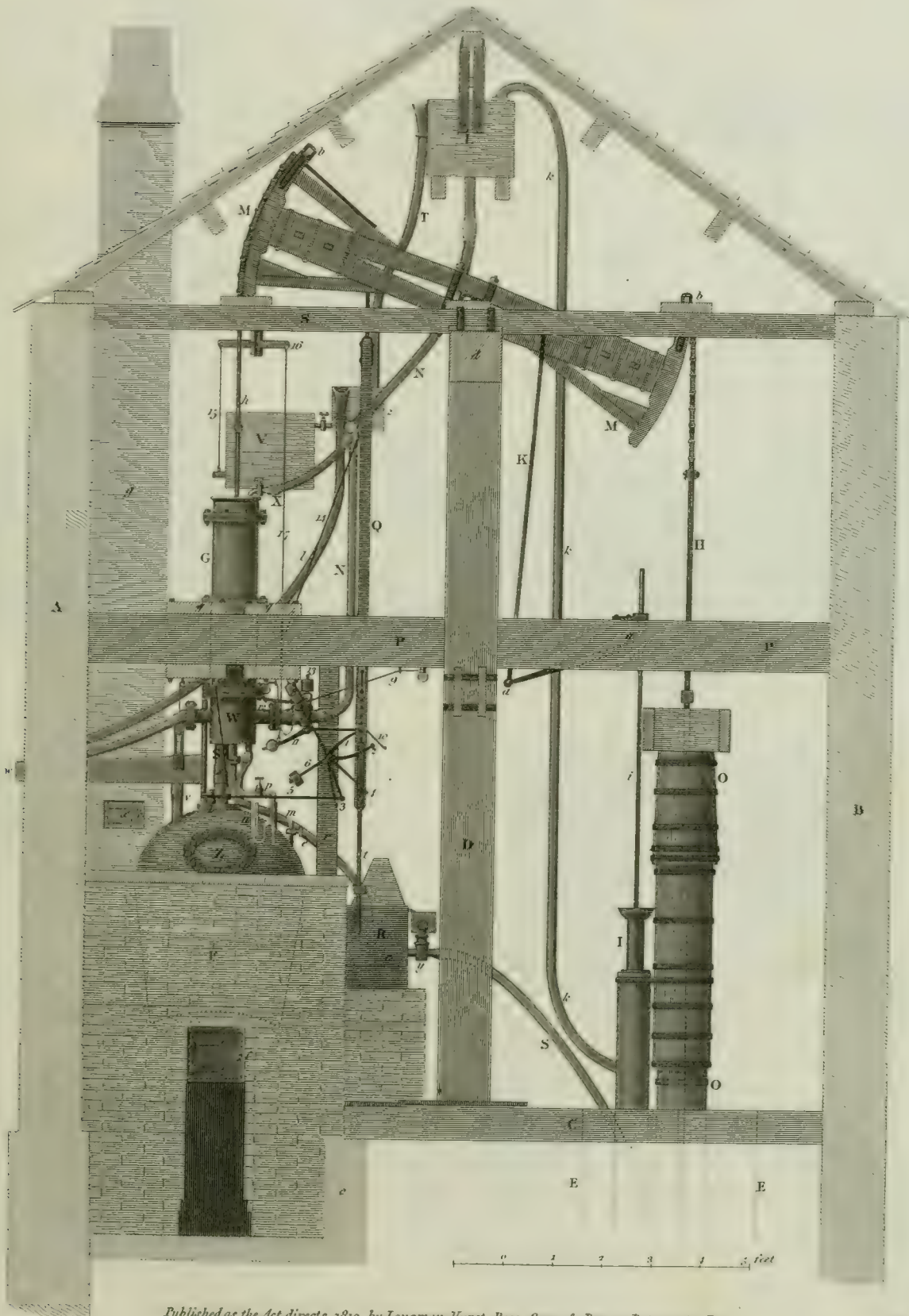

MR WATT'S ENGINE.

Fig. 1.
Single acting ENGINE
for pumping at
CHELSEA WATER-WORKS.

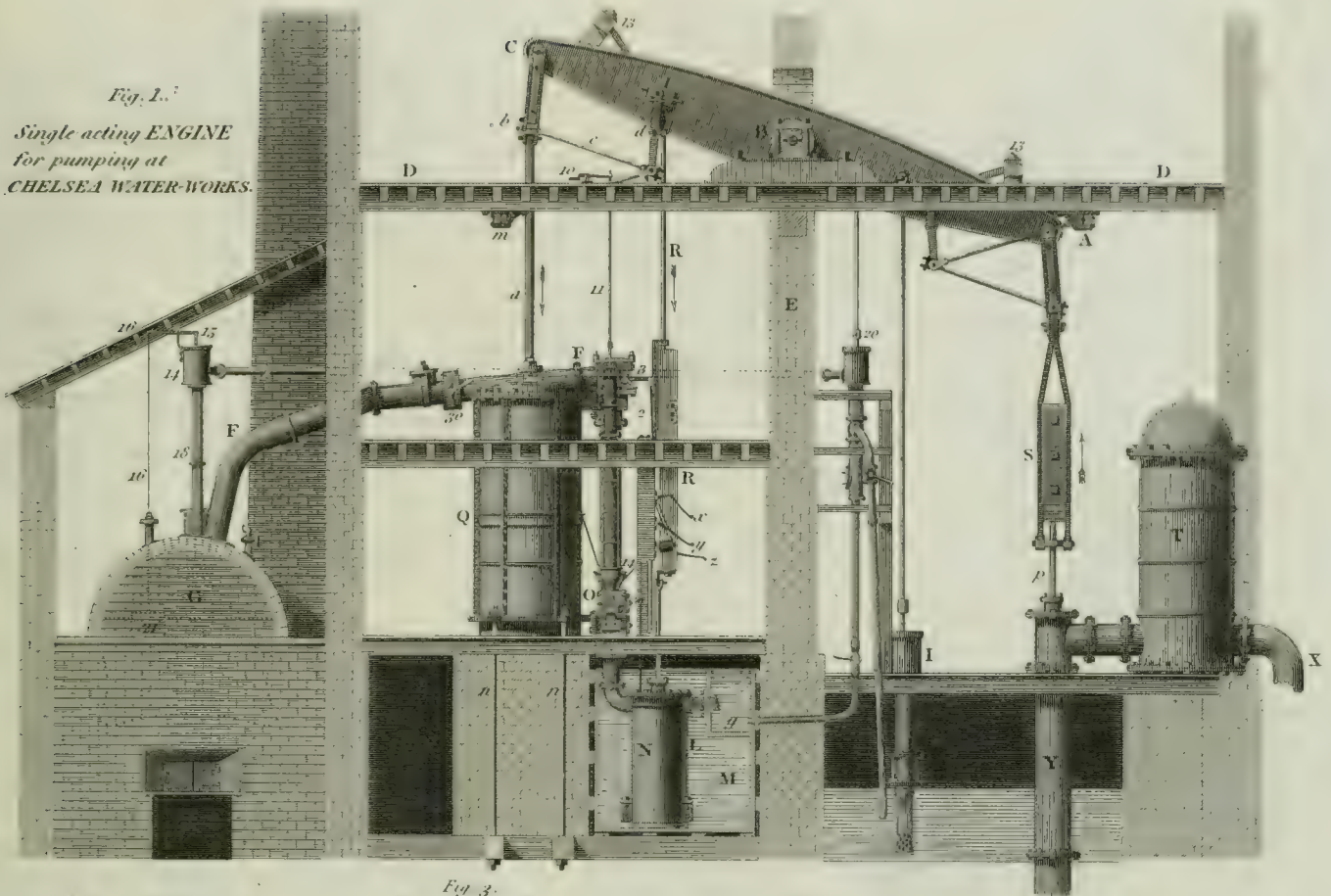

Fig. 2.

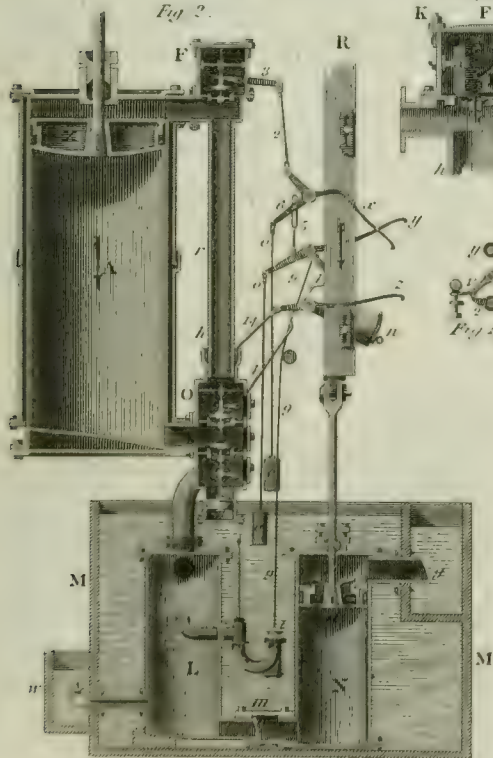

Fig. 3.

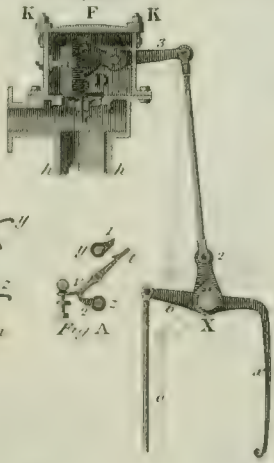

Fig. 4.

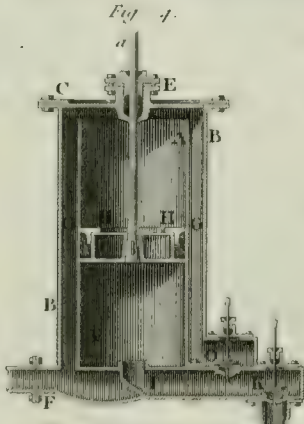

Fig. 5.

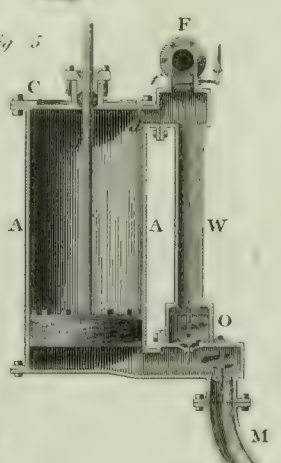

Fig. 6.



Fig. 5.

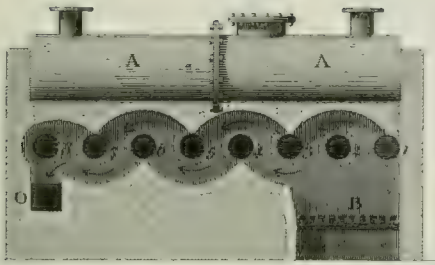

Fig. 4.

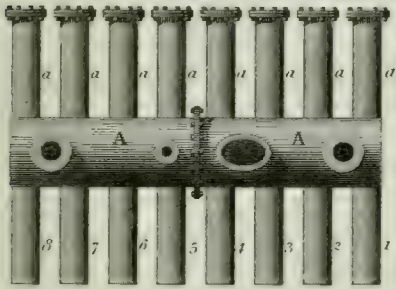
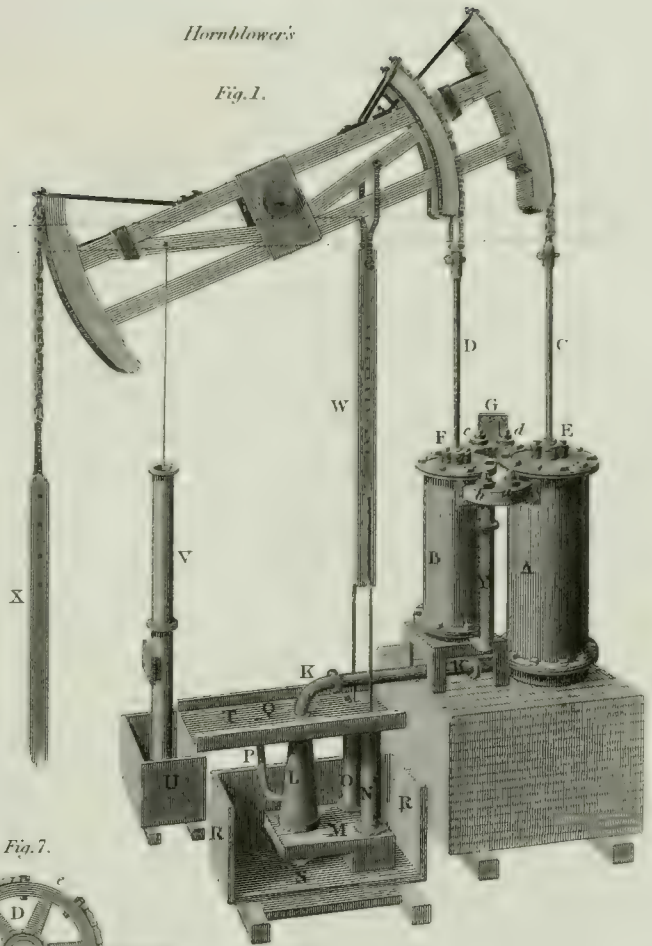

Fig. 2.



Hornblower's

Fig. 1.



Cartwright's

Fig. 8.

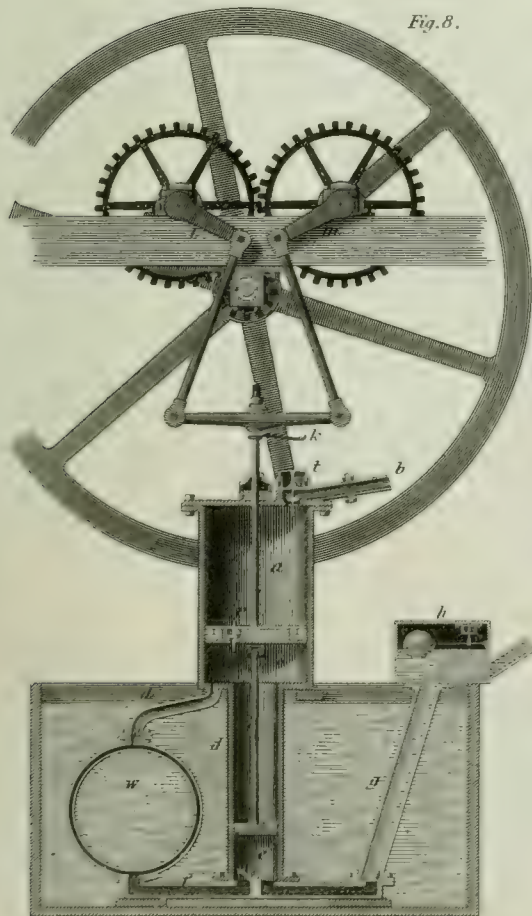

Fig. 7.

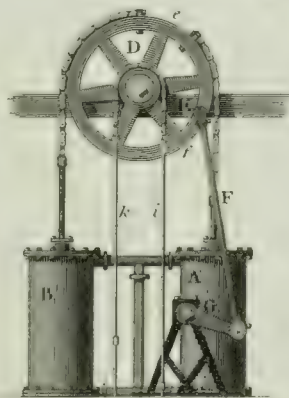
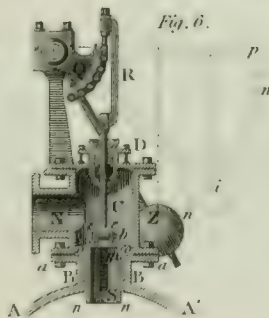
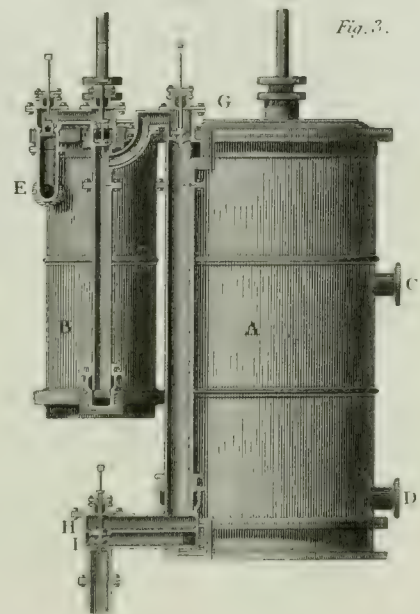

Fig. 6.



Woolf's

Fig. 3.



STEAM ENGINE.

Boulton and Watt's Engine on the original Construction.

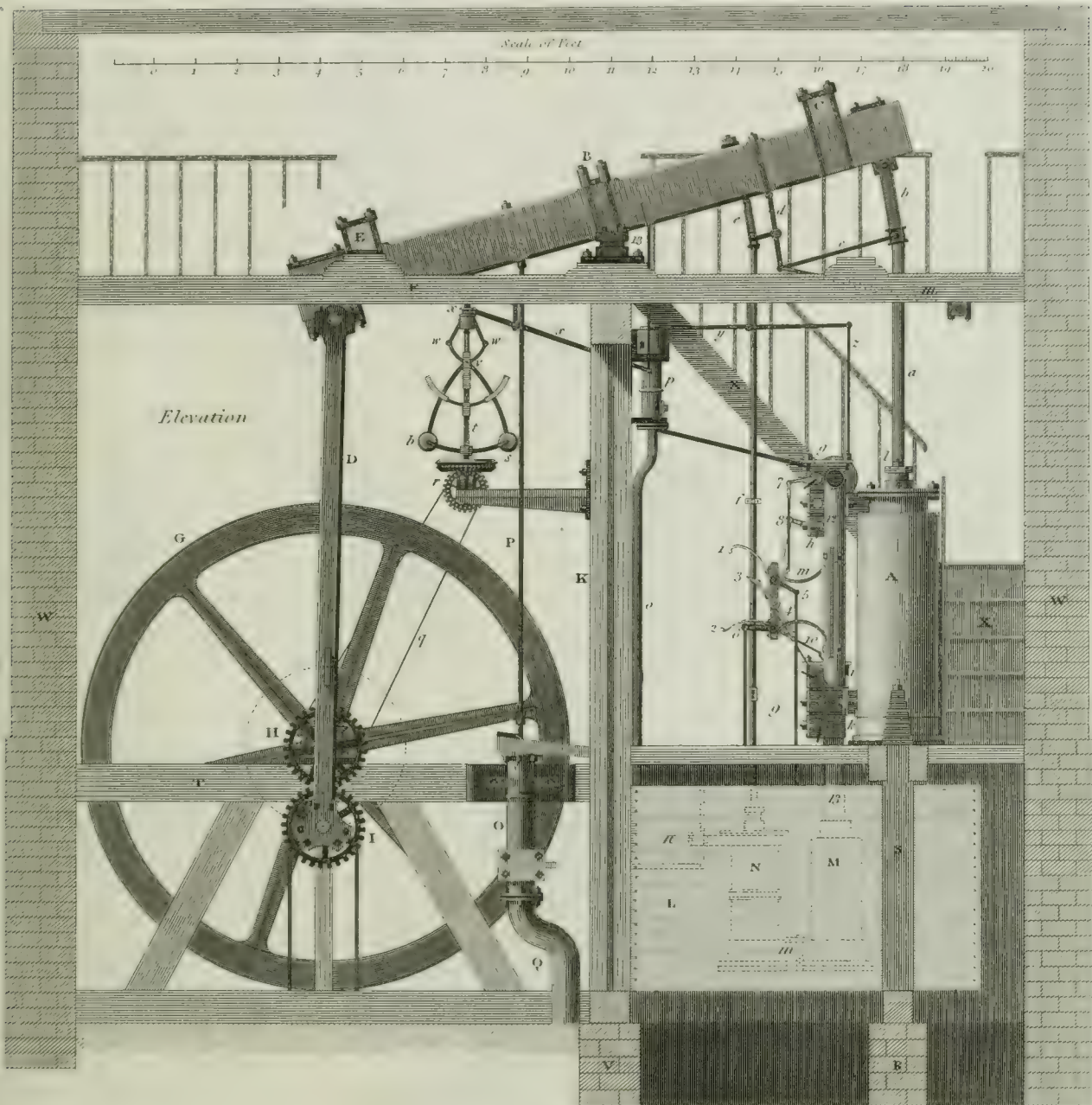

Elevation

Plan of the Beam Floor.

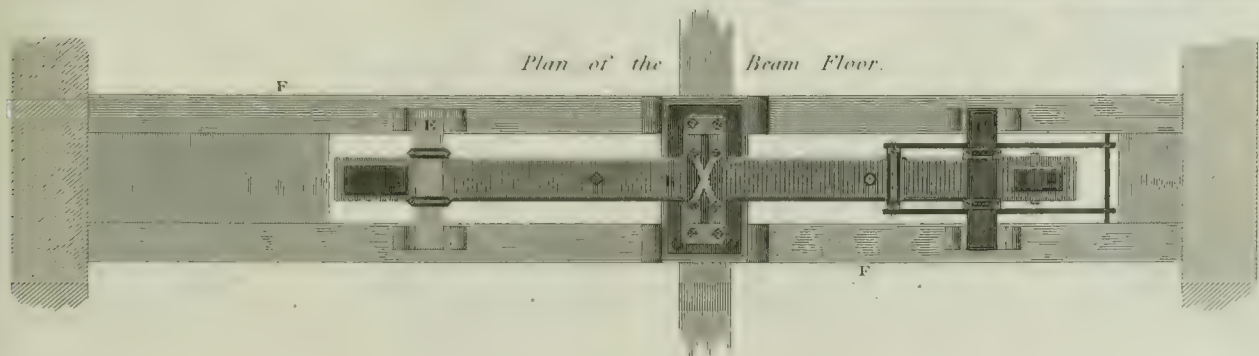

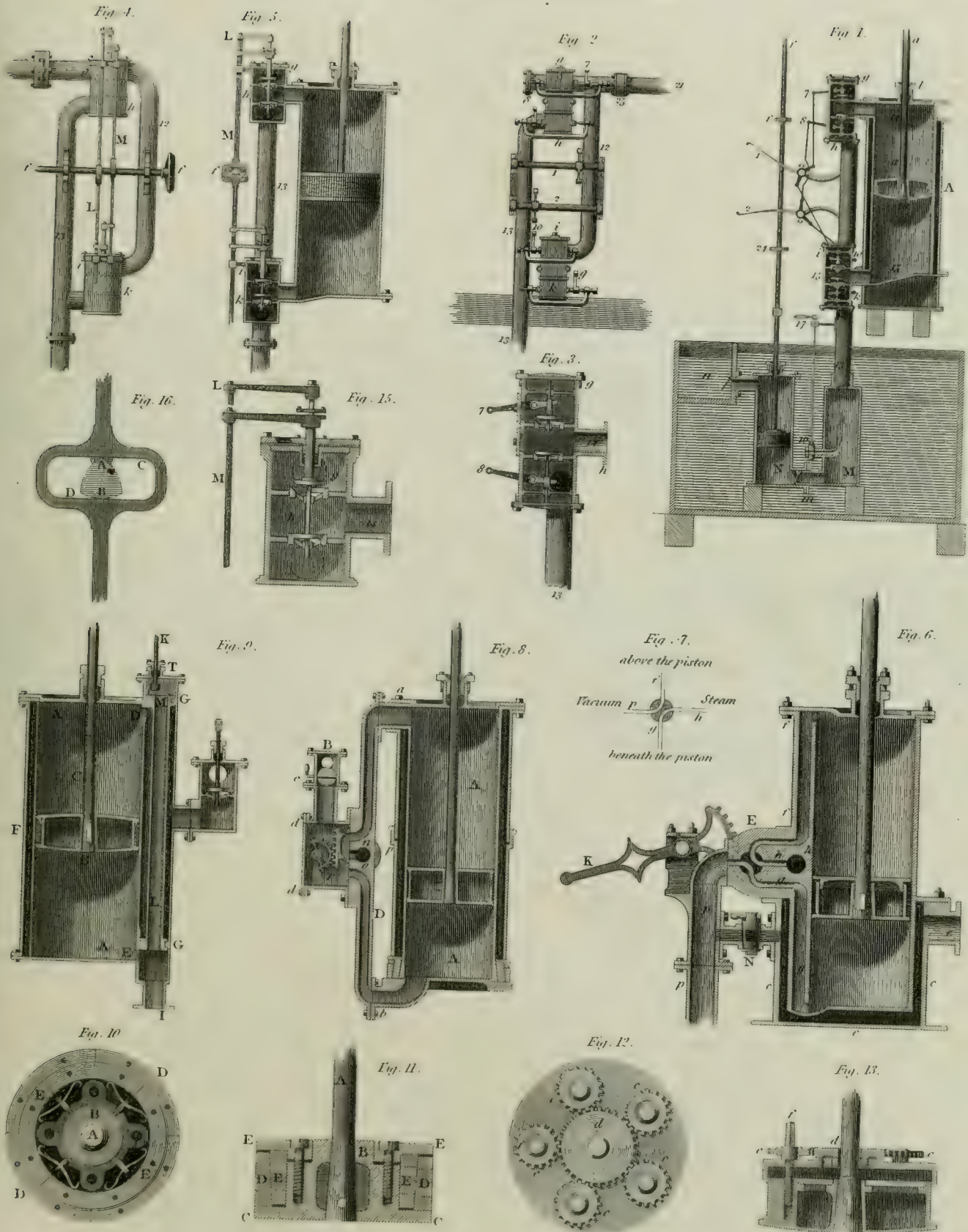

*Elevation
of a
STEAM BOAT.*

Fig 1

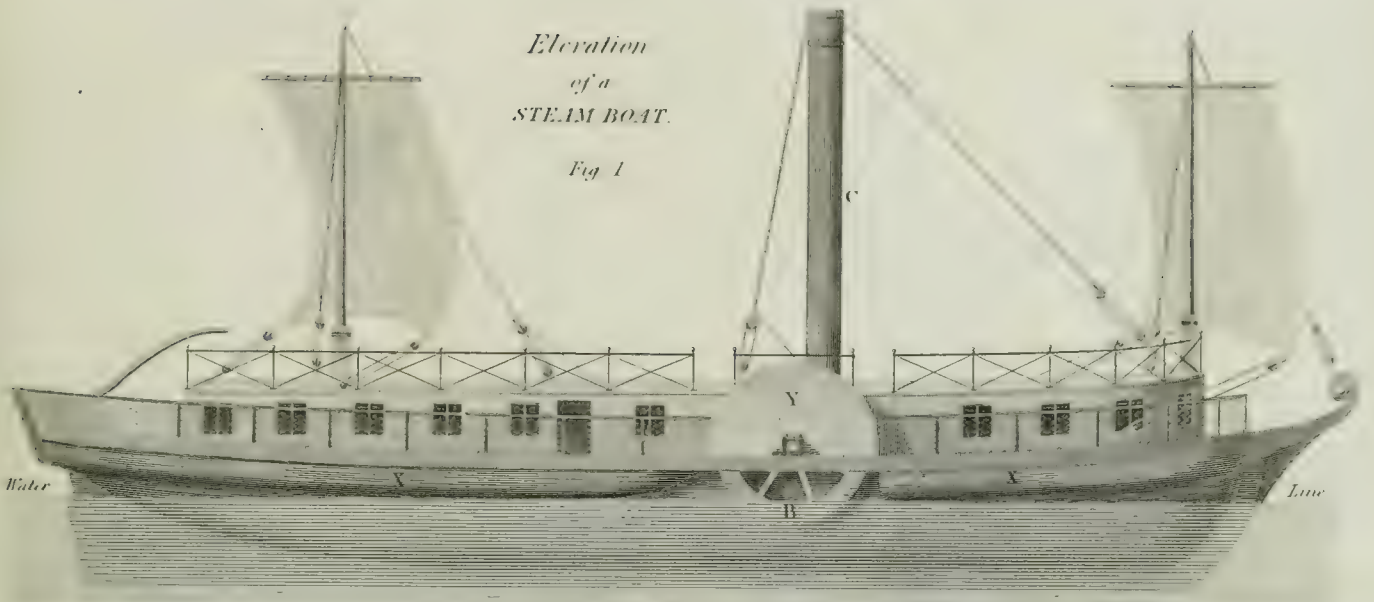

Plan Fig 2

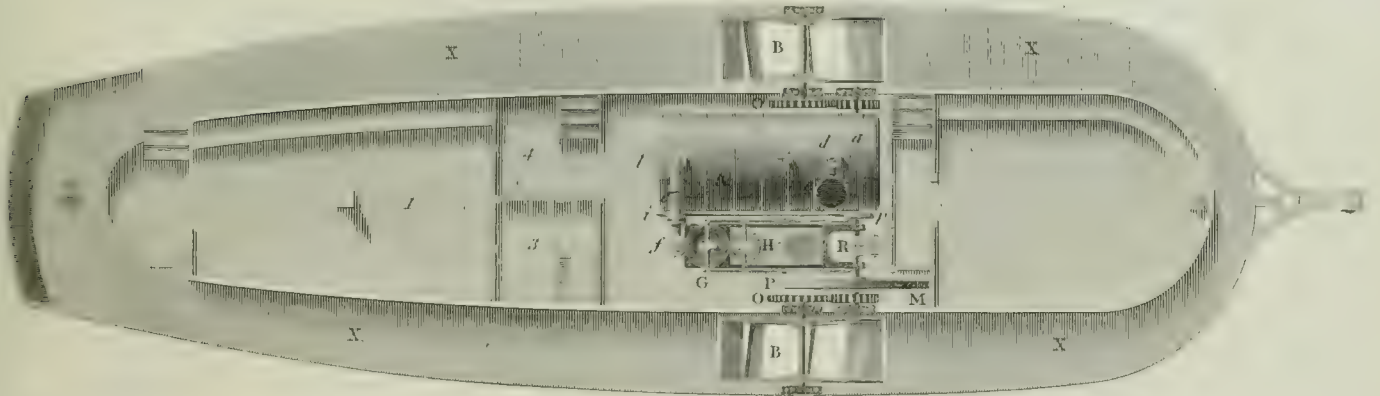

*Maudslay's
STEAM ENGINE.*

Fig 3.

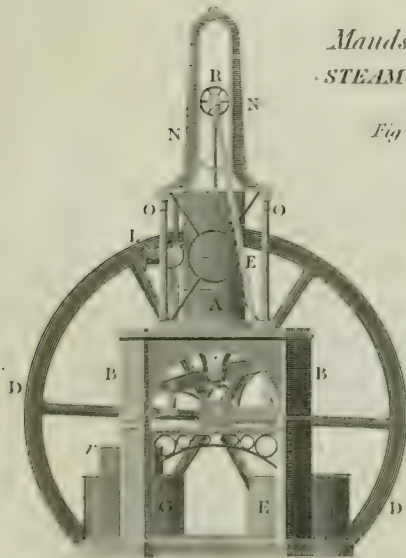

*Murray's
STEAM ENGINE.*

Fig 4.

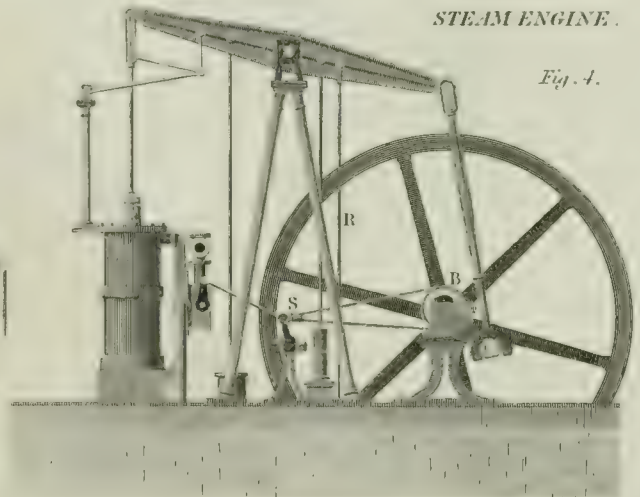
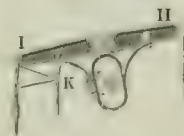

Fig 5.



STEAM ENGINE.

High Pressure STEAMENGINE used with the Dredging Machine on the River Thames.

Elevations

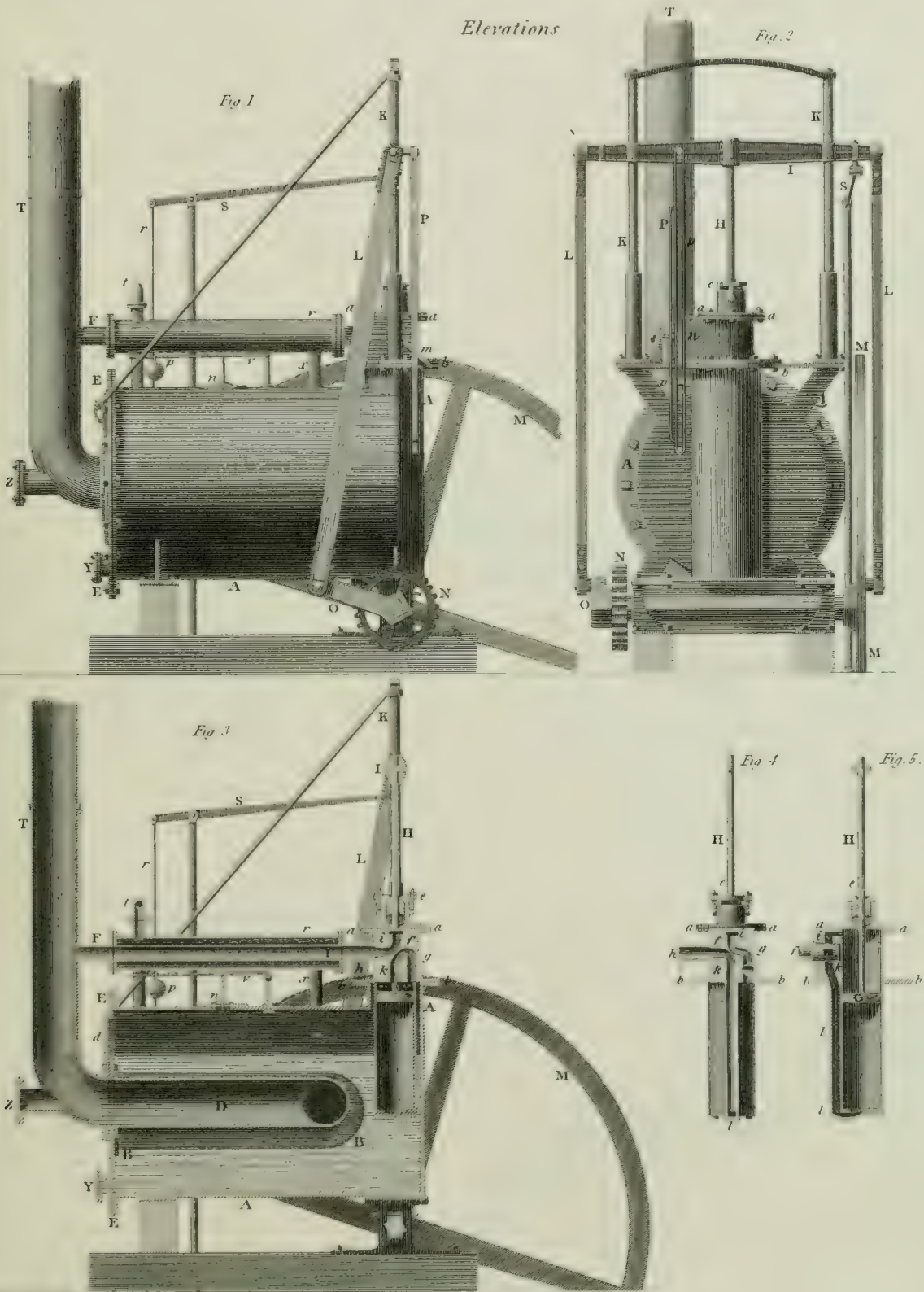

STEAM ENGINE.
PARALLEL MOTIONS.

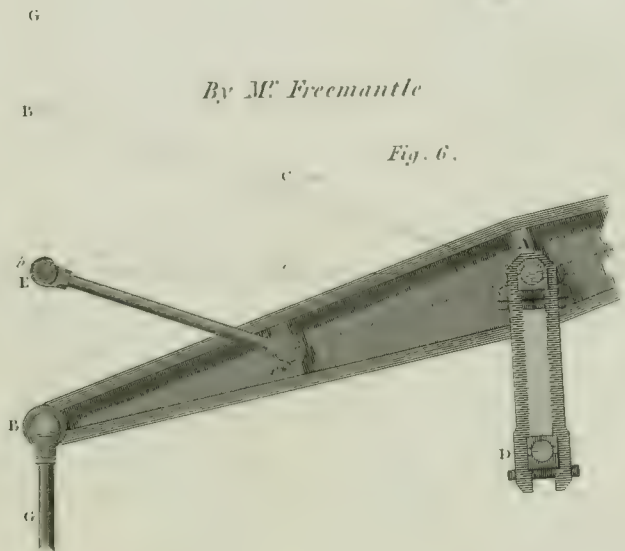
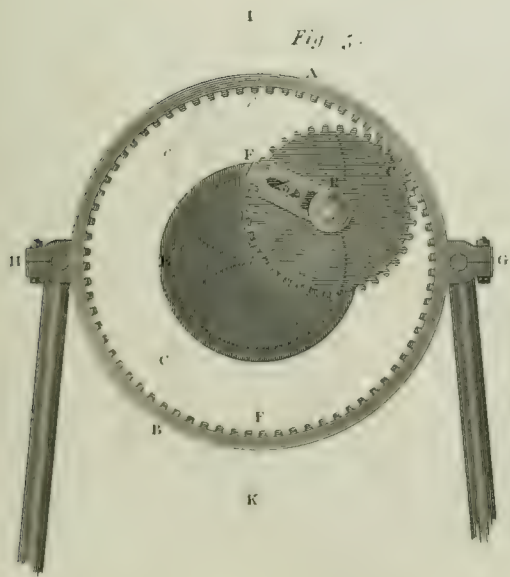
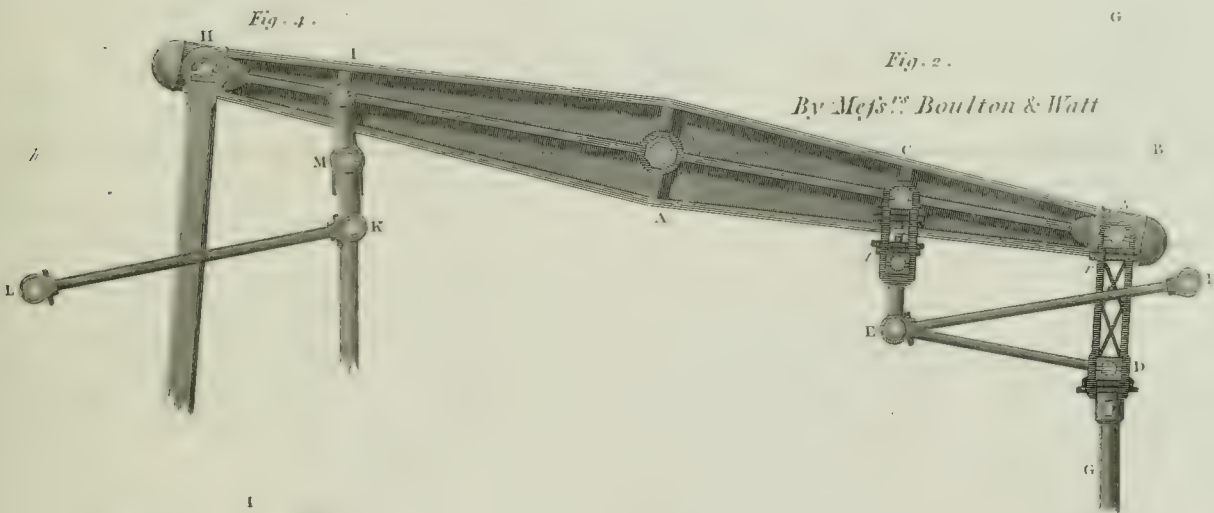
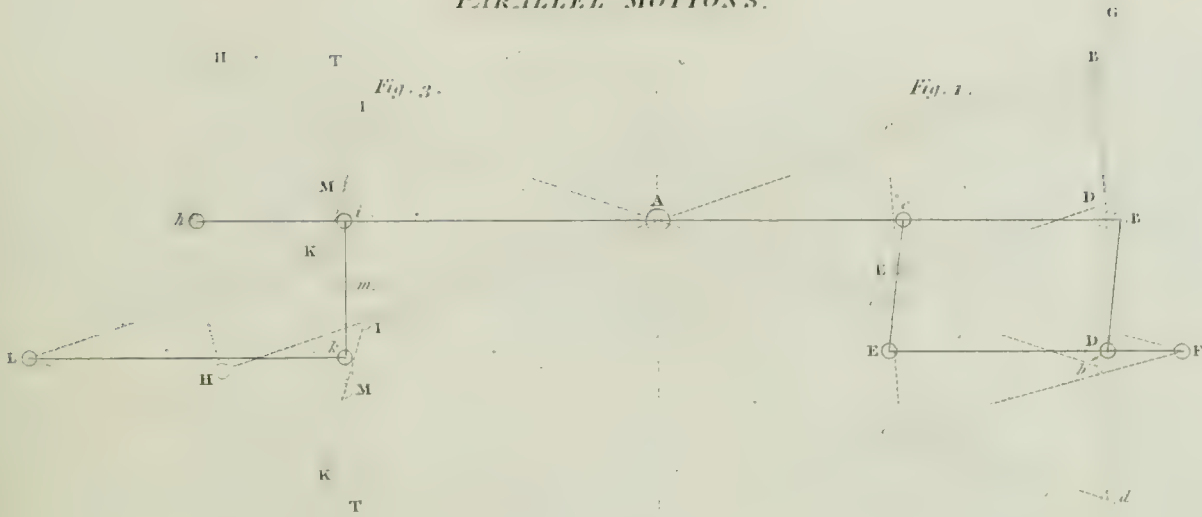

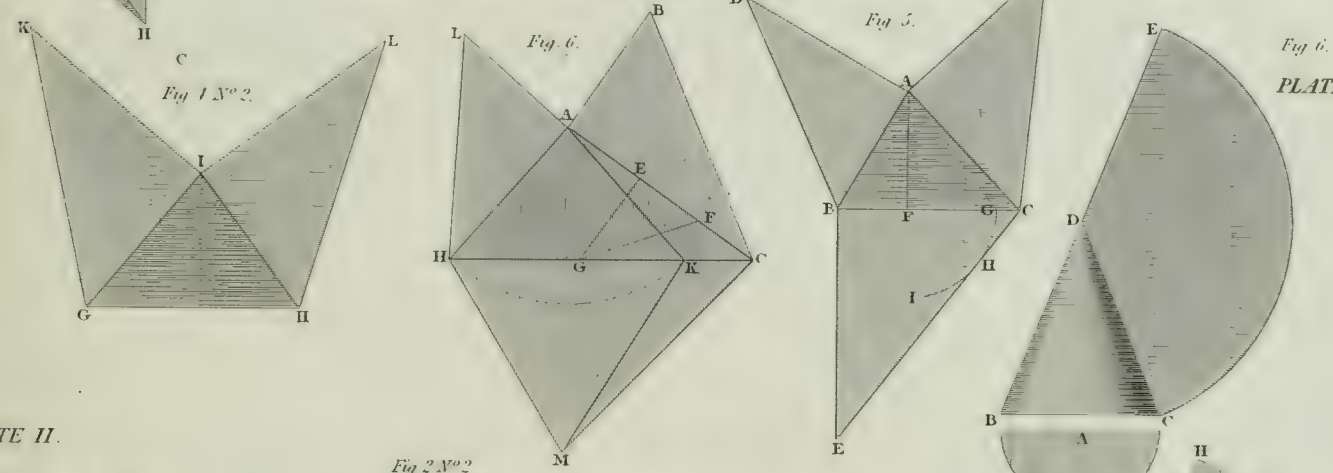
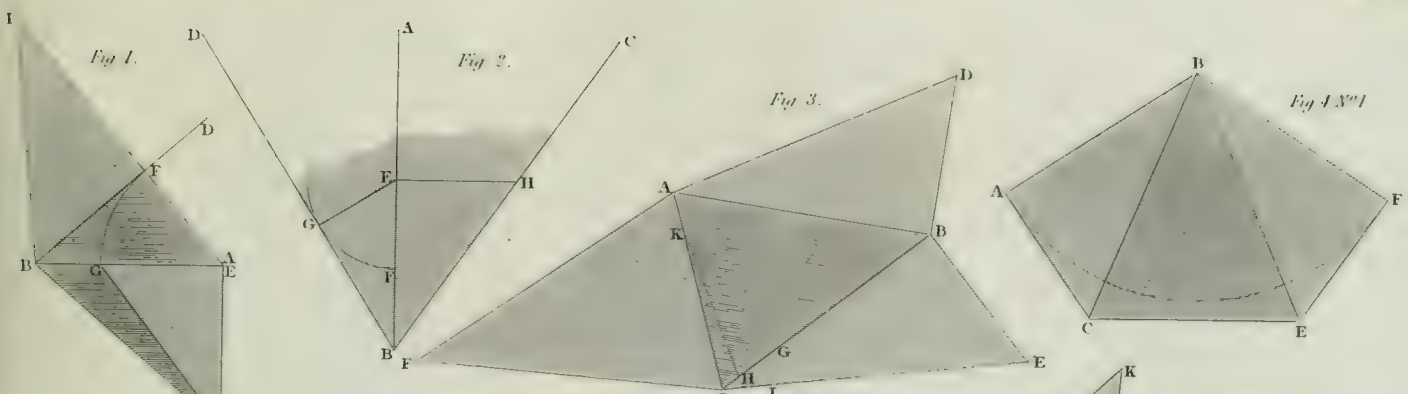
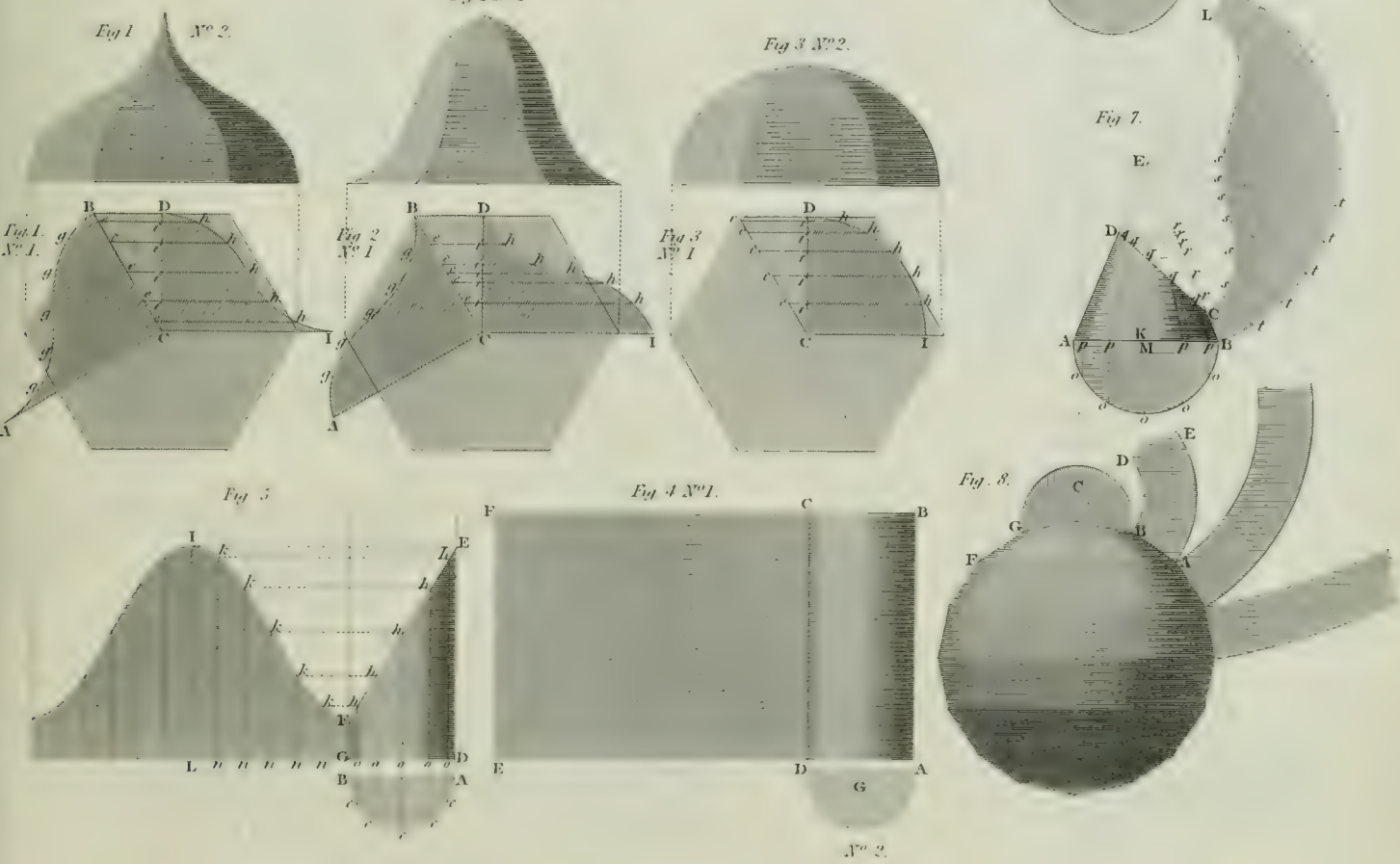

PLATE II.



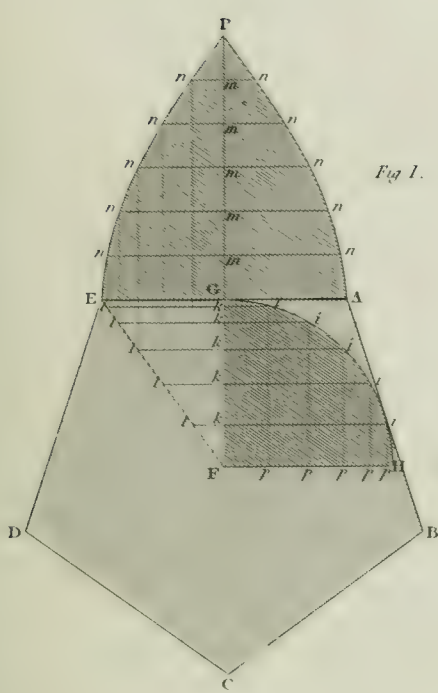

Fig. 1.

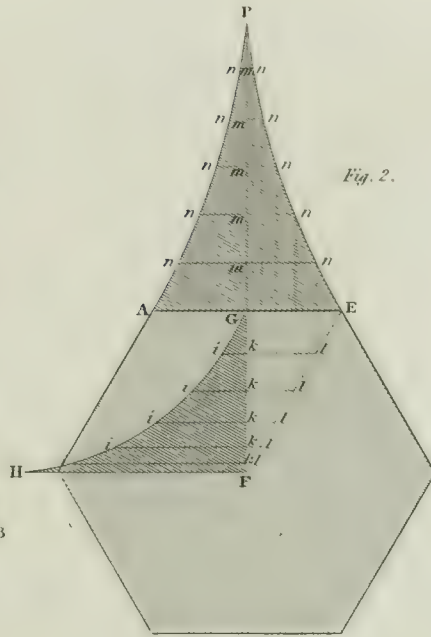

Fig. 2.

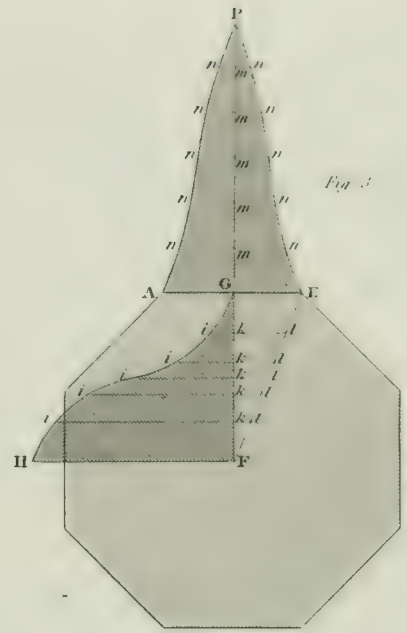

Fig. 3.

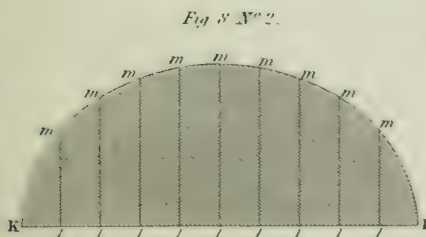

Fig. 4 No. 2.

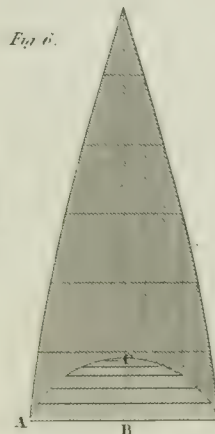

Fig. 6.

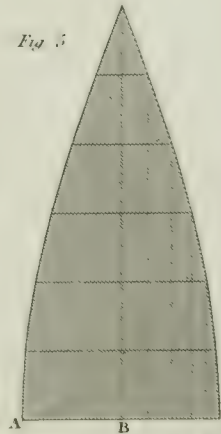

Fig. 5.

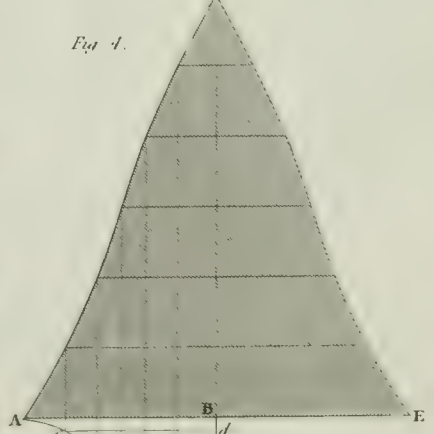

Fig. 7.

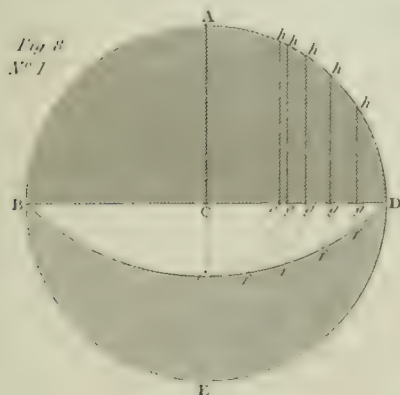

Fig. 8 No. 1.

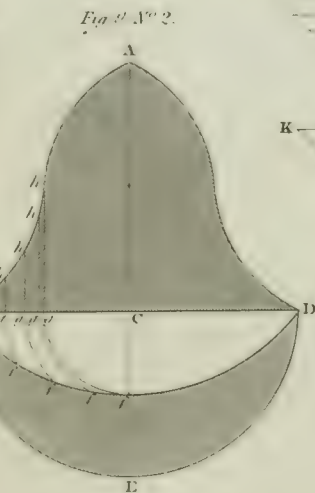

Fig. 9 No. 2.

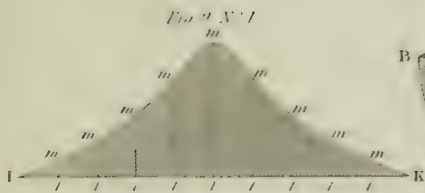

Fig. 10 No. 1.

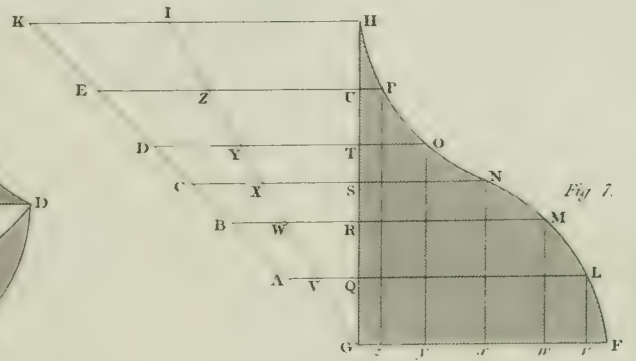

Fig. 7.

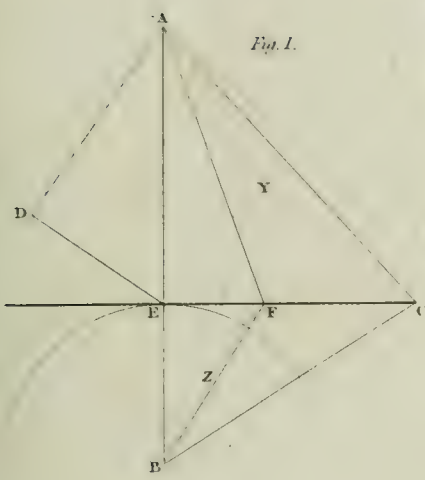

Fig. 1.

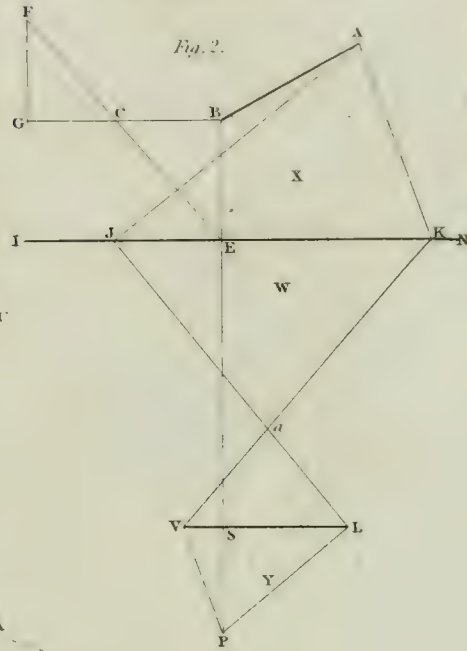

Fig. 2.

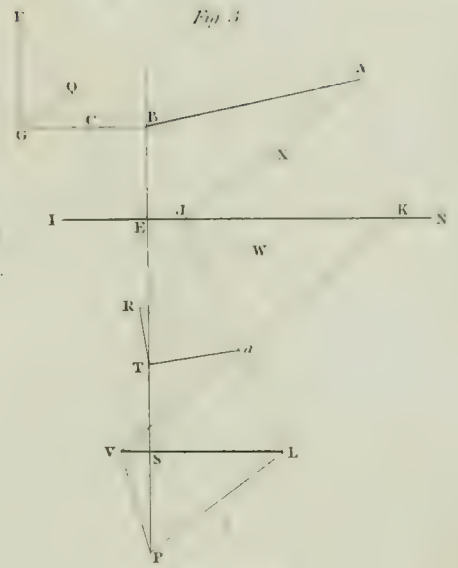

Fig. 3.

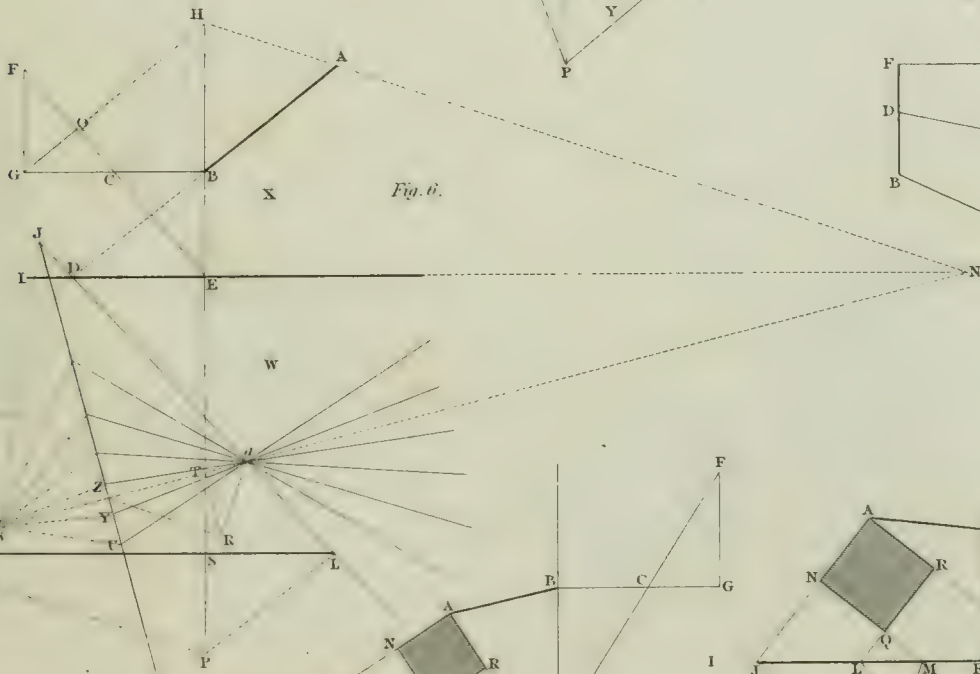

Fig. 6.

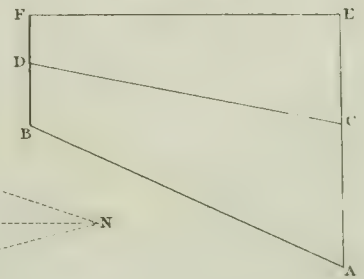

Fig. 4.

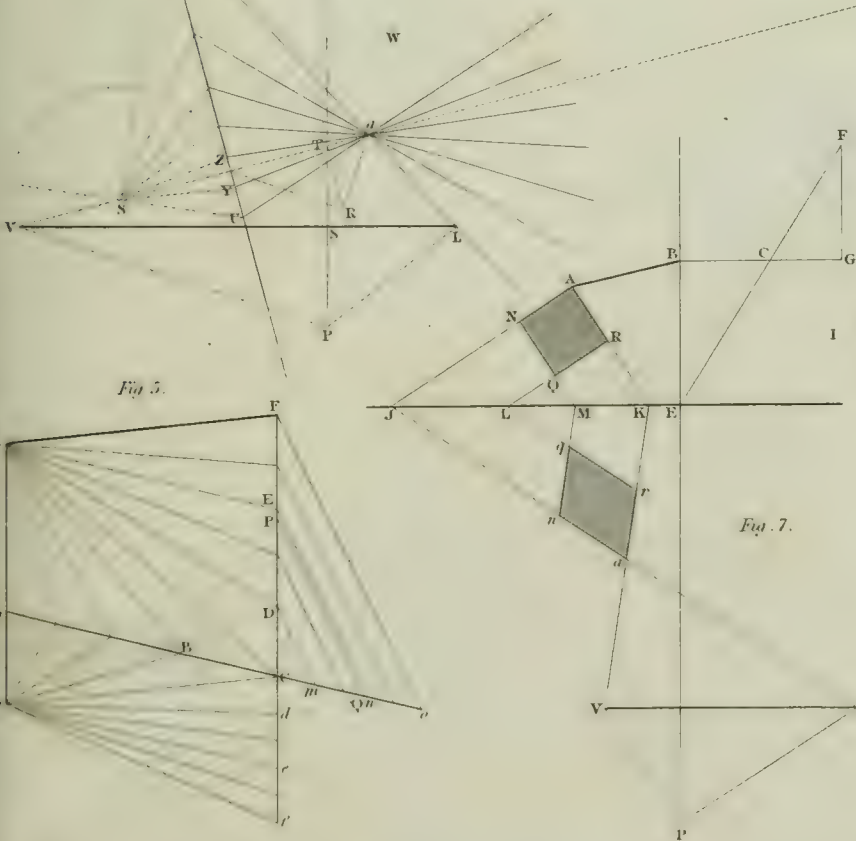

Fig. 5.

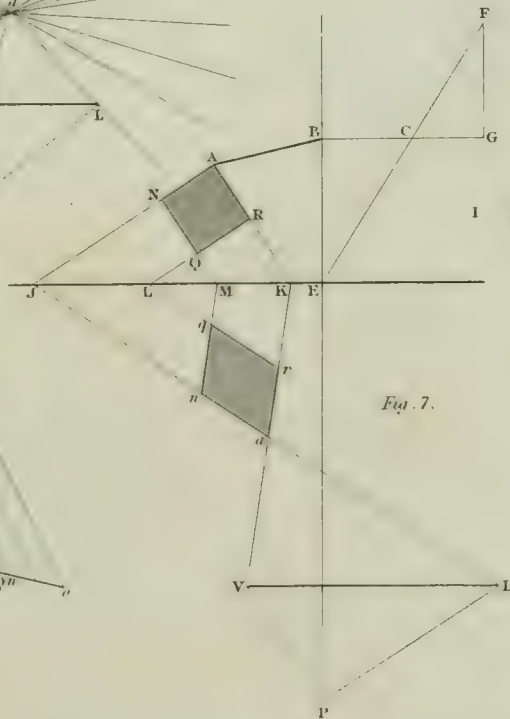

Fig. 7.

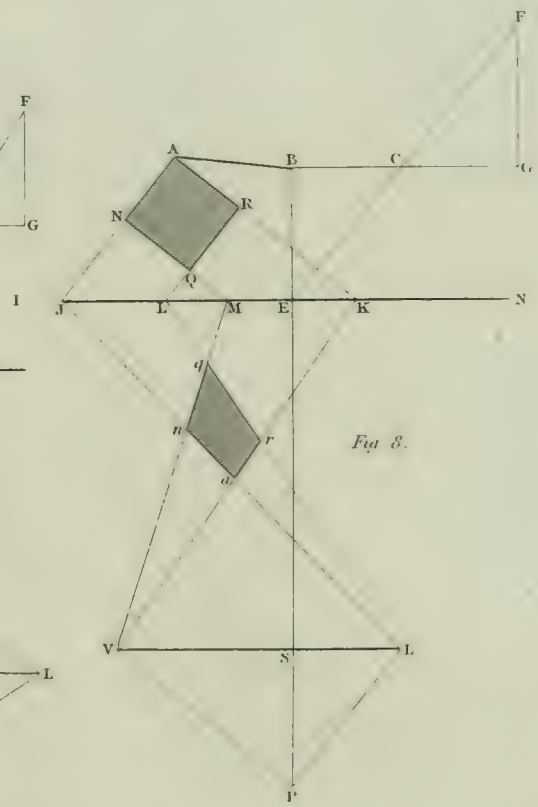

Fig. 8.

Fig. 1

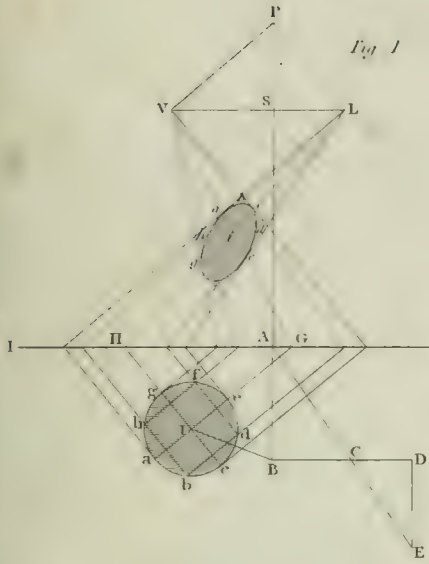

Fig. 2

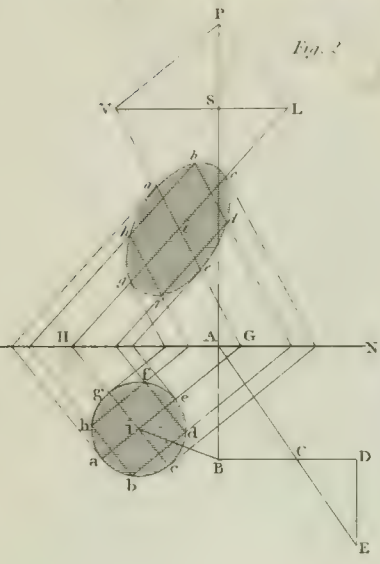

Fig. 3

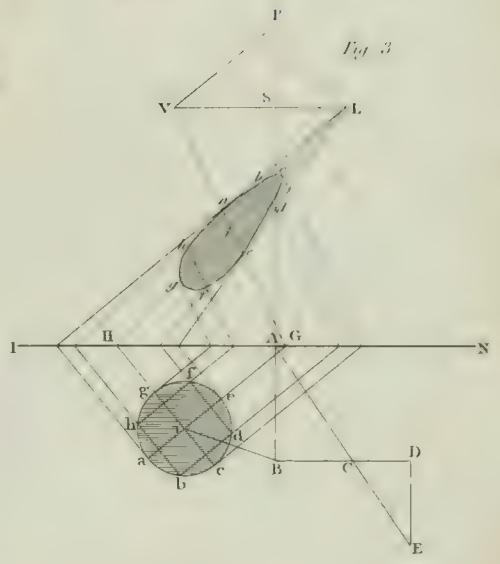

Fig. 4.

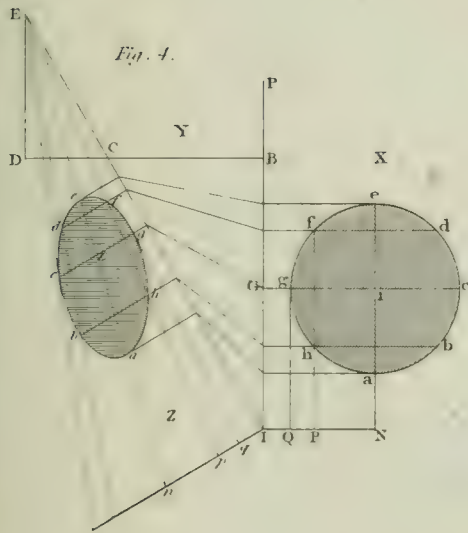

Fig. 5.

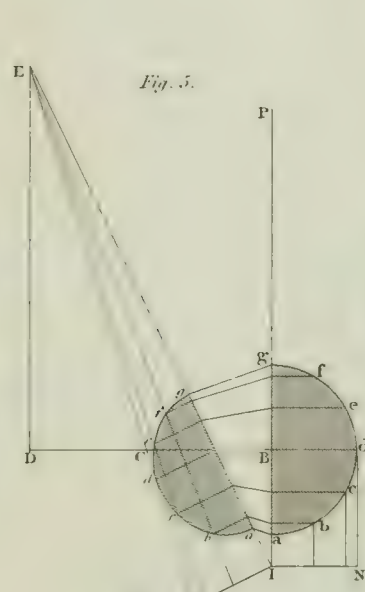

Fig. 6.

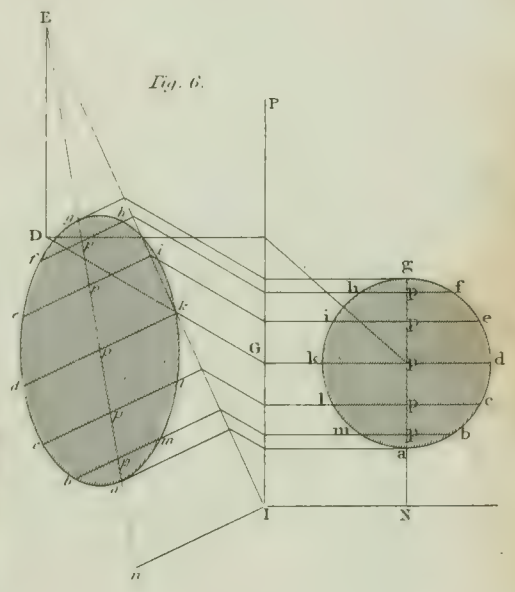

Fig. 7.

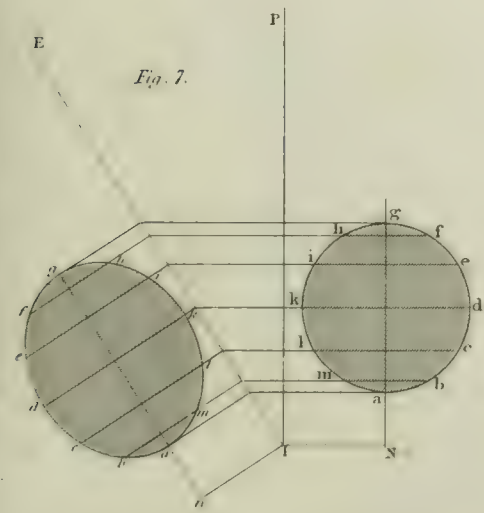

Fig. 8.

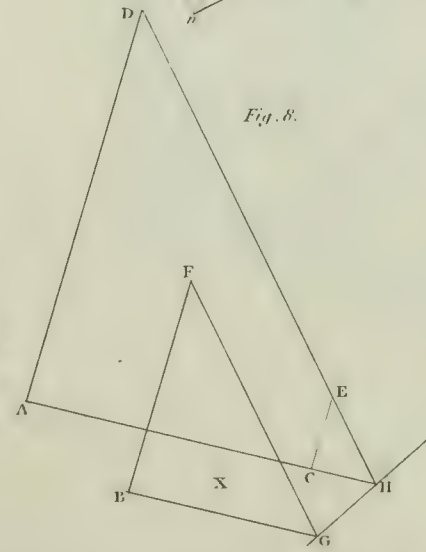
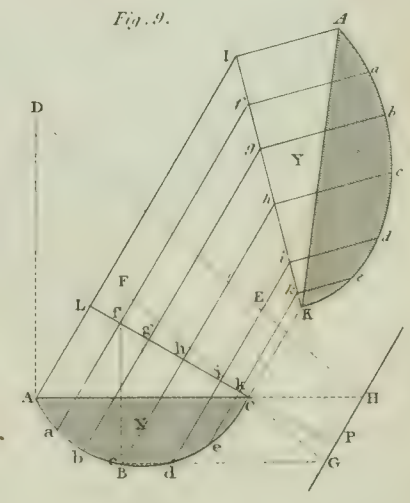

Fig. 9.





STOCKING FRAME.

Fig. 1.

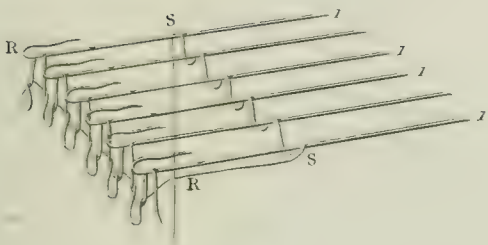

Fig. 3.

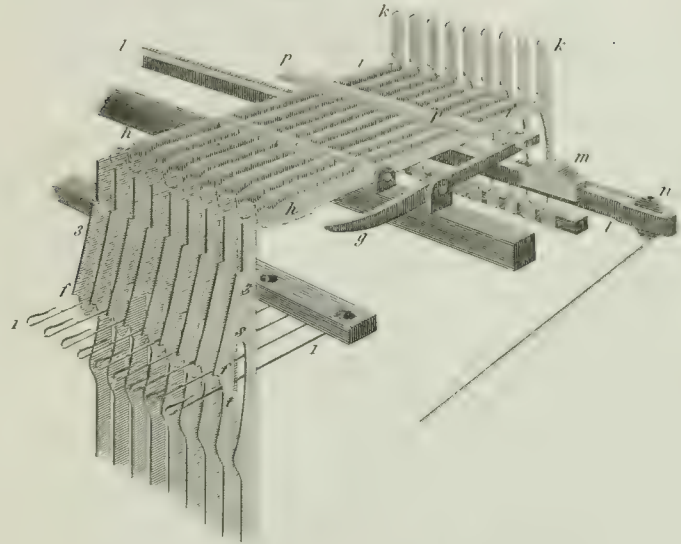

Fig. 7.

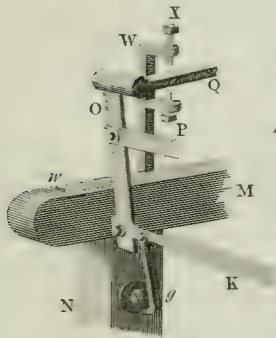

Fig. 2.

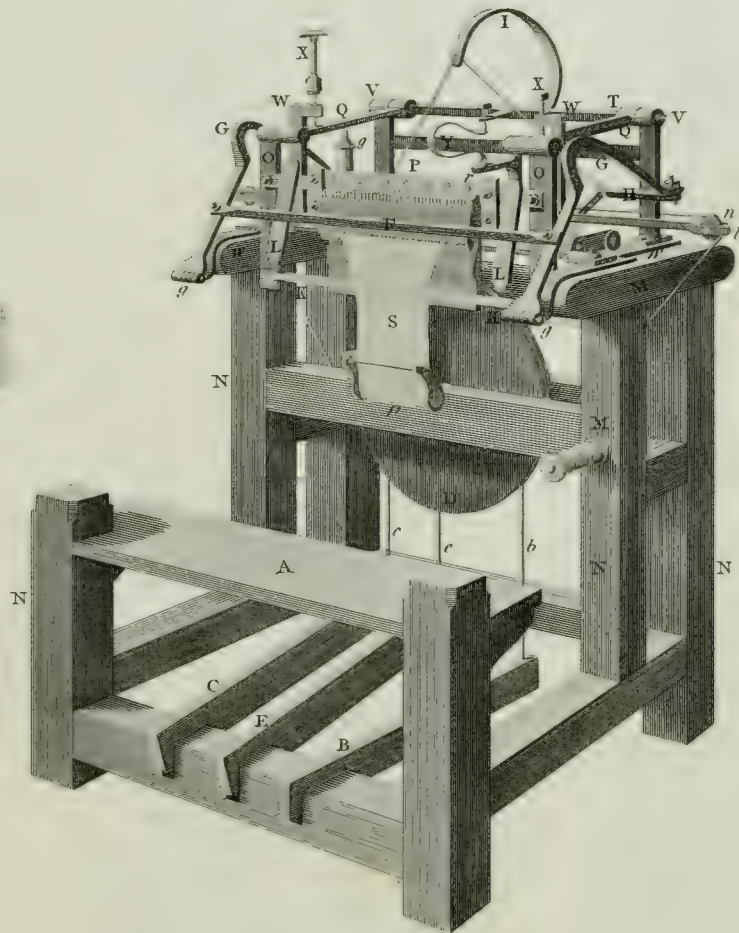
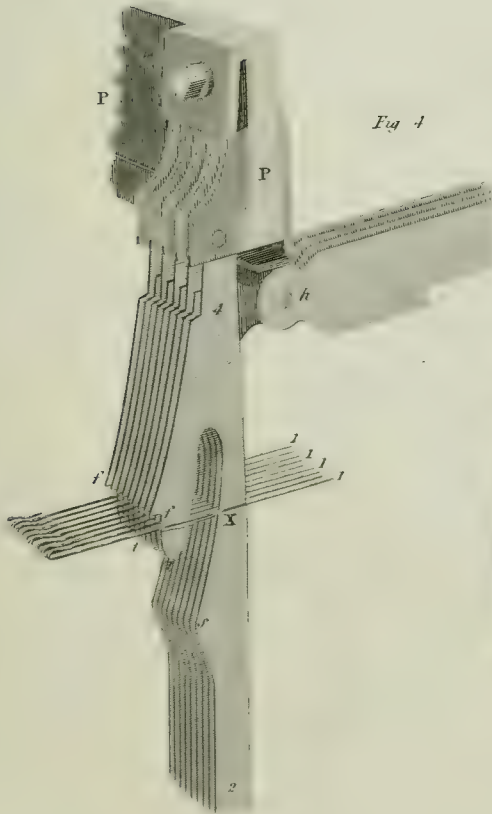
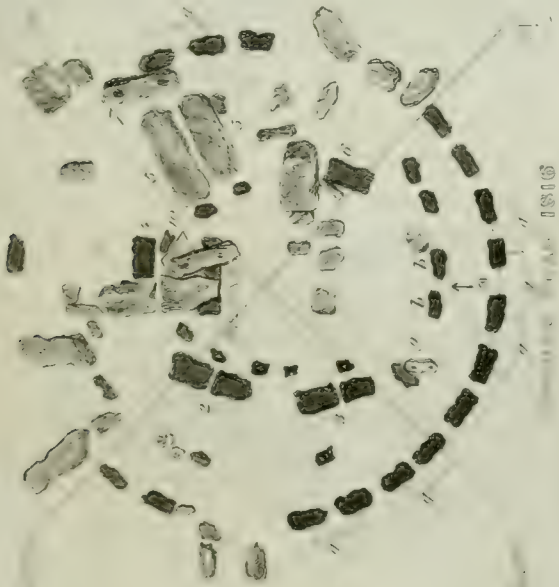

Fig. 4.



STONEHENGE
WILTSHIRE, ENGLAND.

D



1816

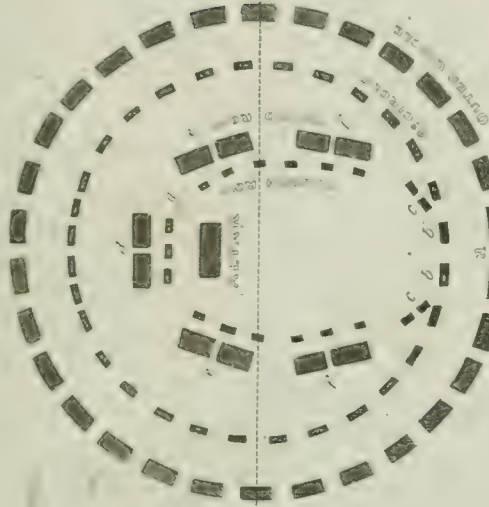

Line of A

EAST ENTRANCE
GROUND PLAN AS ORIGINALLY.

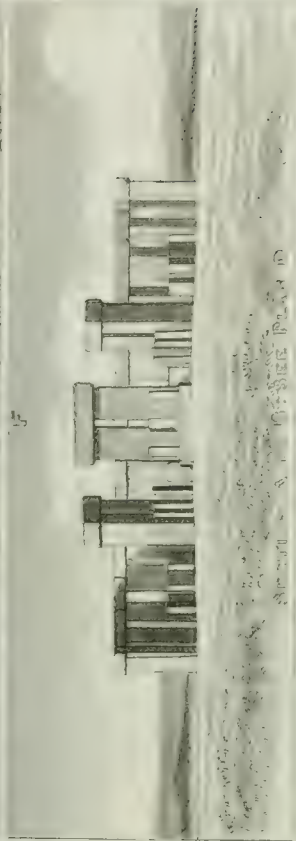

J. Britton, del. 1816.

London Field, into the English House, Rev. Anne & F. W. W. Pitt Rivers, 1816.

W. Leary, sculp.

SUGAR MILL.

Elevation Fig. 1.

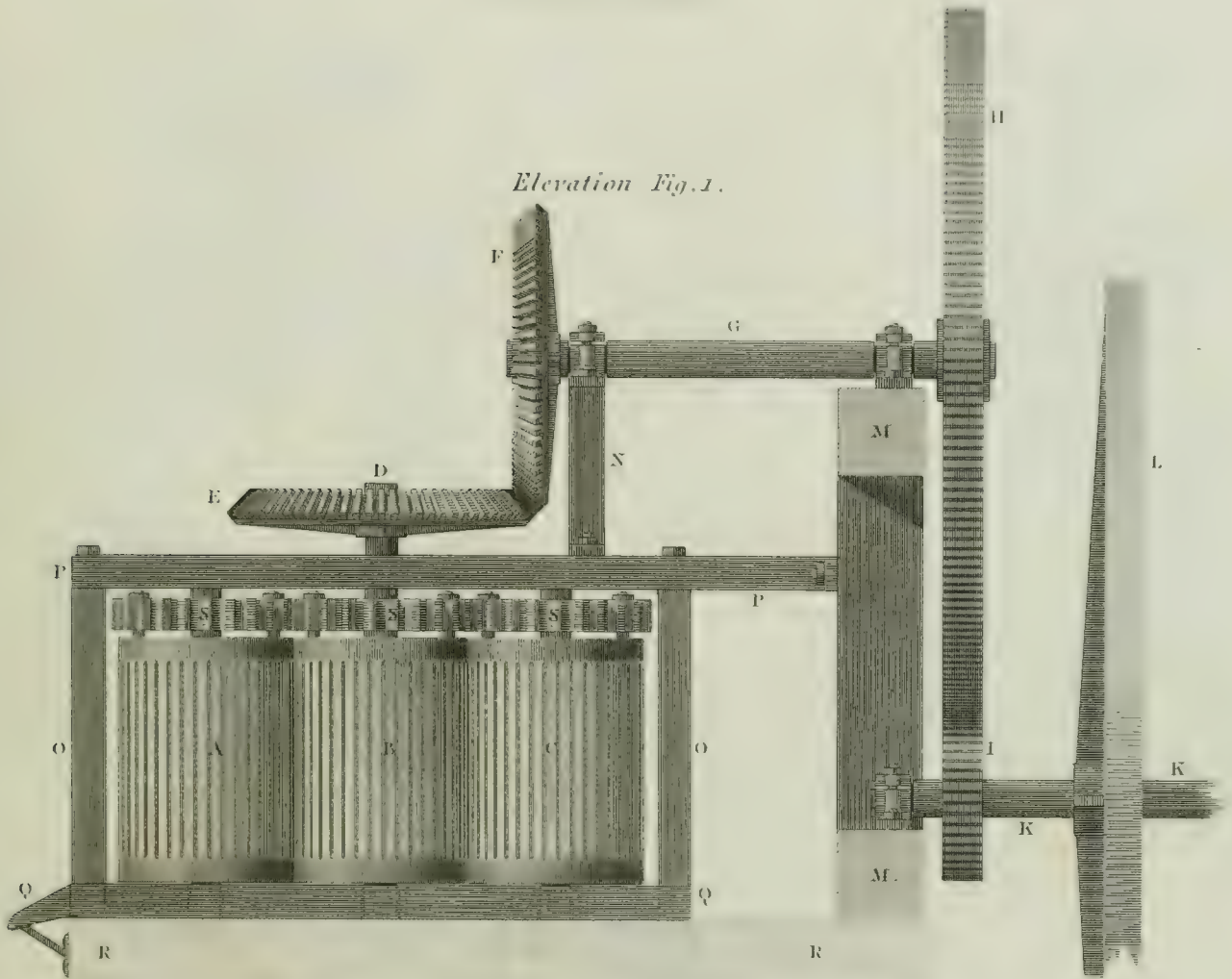

Plan Fig. 2.

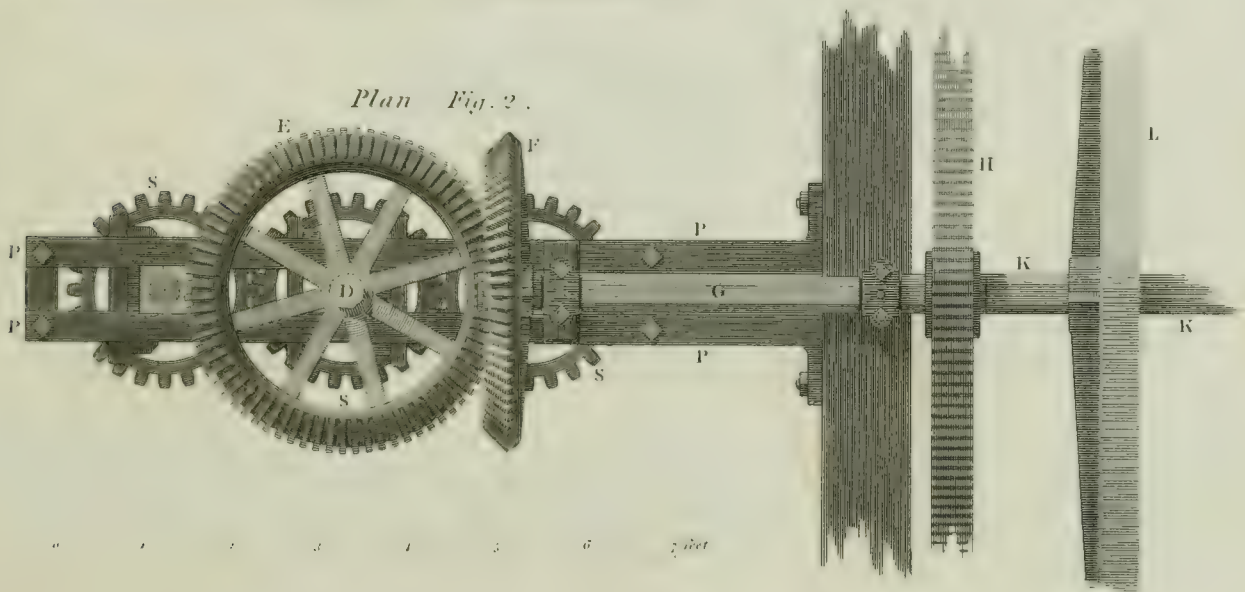

TOURNIQUETS AND AMPUTATING INSTRUMENTS.

Fig. 3.

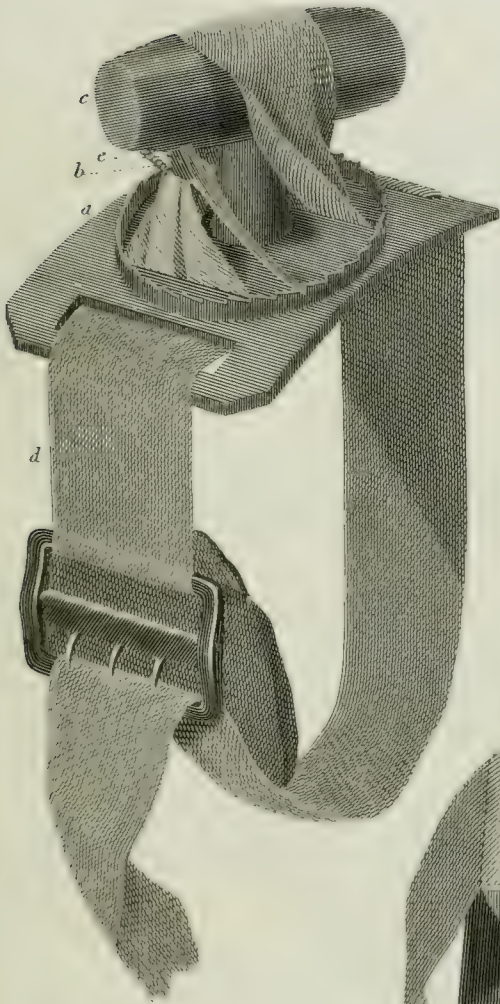

Fig. 1.

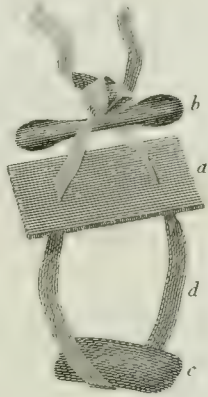

Fig. 2.

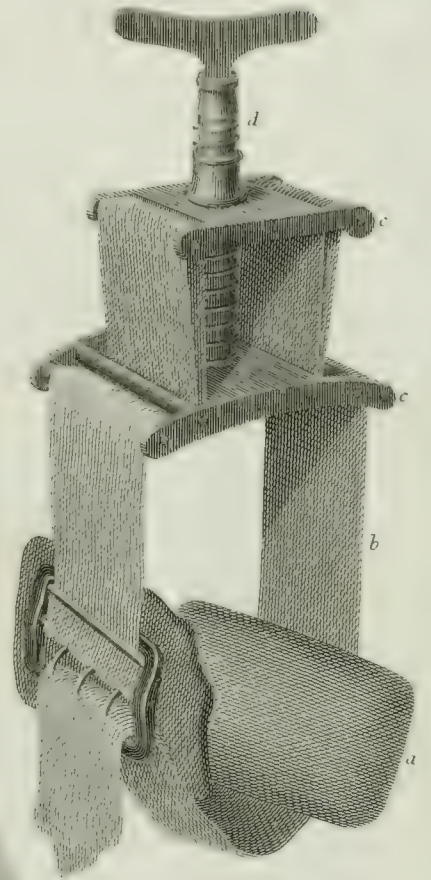

Fig. 4.

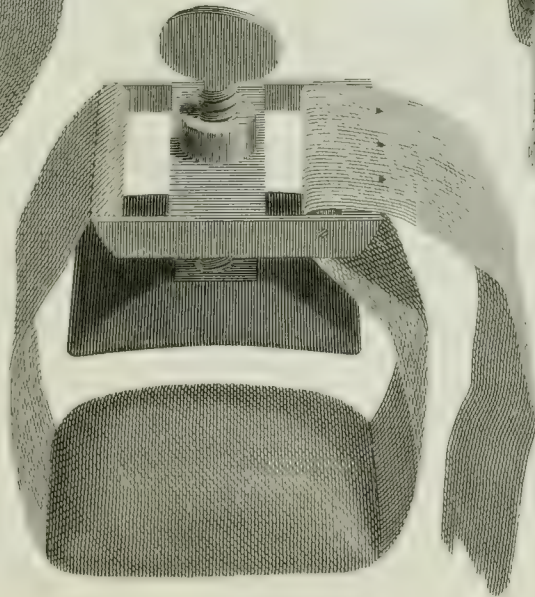

Fig. 5.

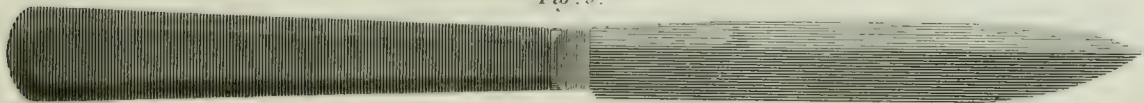

Fig. 6.



Fig. 1. Amputating Saw.

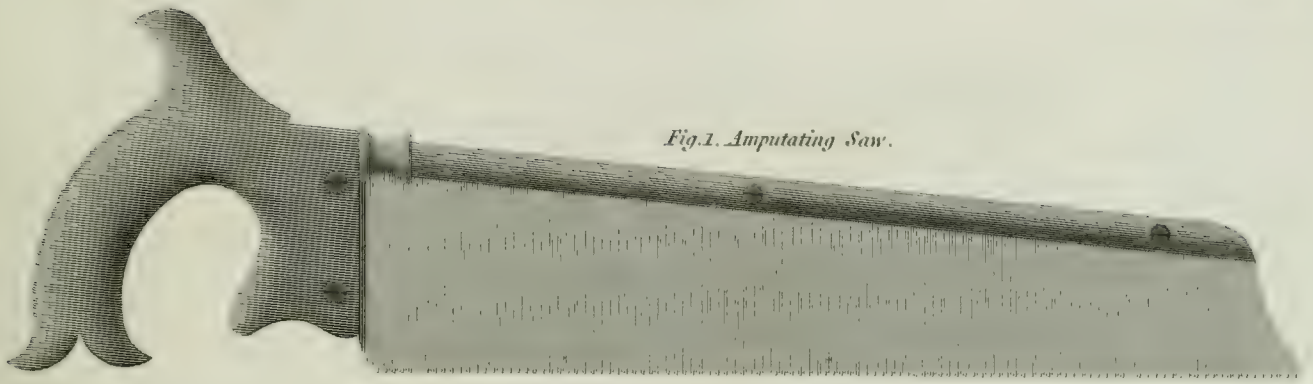

Fig. 2. Large Amputating Knife.

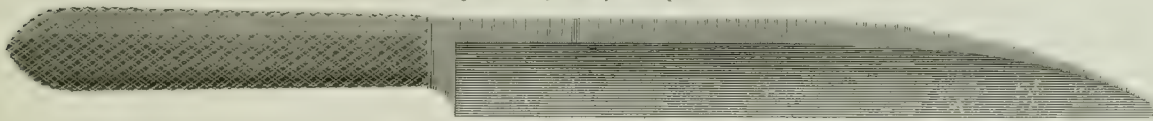

Fig. 3. One of smaller size.

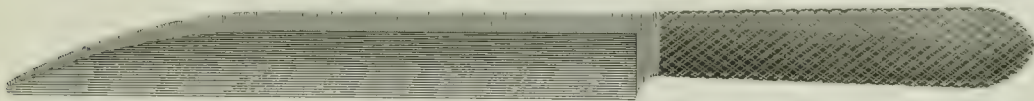

Fig. 4. Catling.

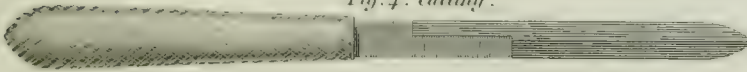

Fig. 5. Metacarpal Saw.

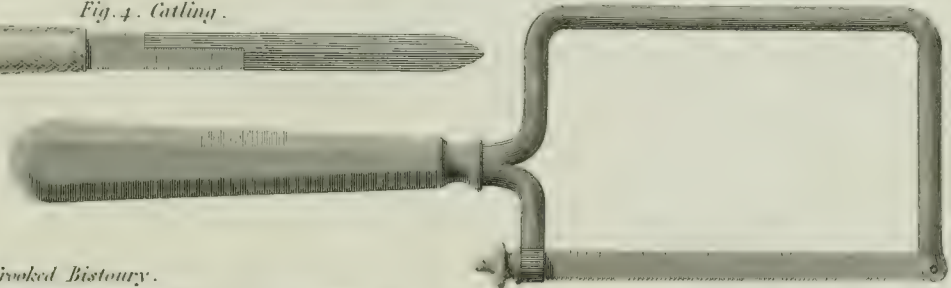

Fig. 6. Crooked Bistoury.



Fig. 7. Probe pointed crooked Bistoury.

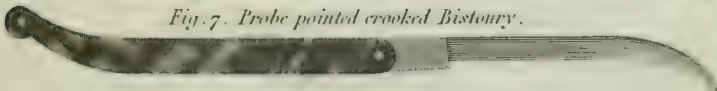

Fig. 8. Straight double edged Scalpel.

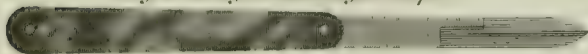

Fig. 9. Tenaculum.

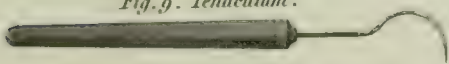

Fig. 10. Aneurysm Needle.



Fig. 11.

Forceps for taking up the mouths of vessels. Employed also in several operations, in which careful dissection is requisite.

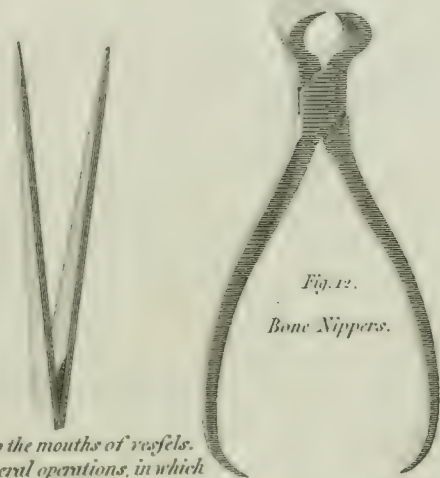

Fig. 12. Bone Nippers.

Fig. 1.

Fig. 2.

Fig. 3.

Needles for sewing up Wounds.

Fig. 4. Spalata.

Fig. 5. Lancet.

Fig. 6. Eye Probe.

Fig. 7. Caustic Case.

Fig. 9. Common Probe.

Fig. 10. Director.

Fig. 12. Pocket Tomaculum.

Fig. 8.

Common Forceps.

Fig. 11.

Scissors.

Fig. 13.

Female Catheters.

Fig. 14.

Male Catheters.

Fig. 16.

Fig. 17.

Fig. 18.

Fig. 19.

SURGERY.

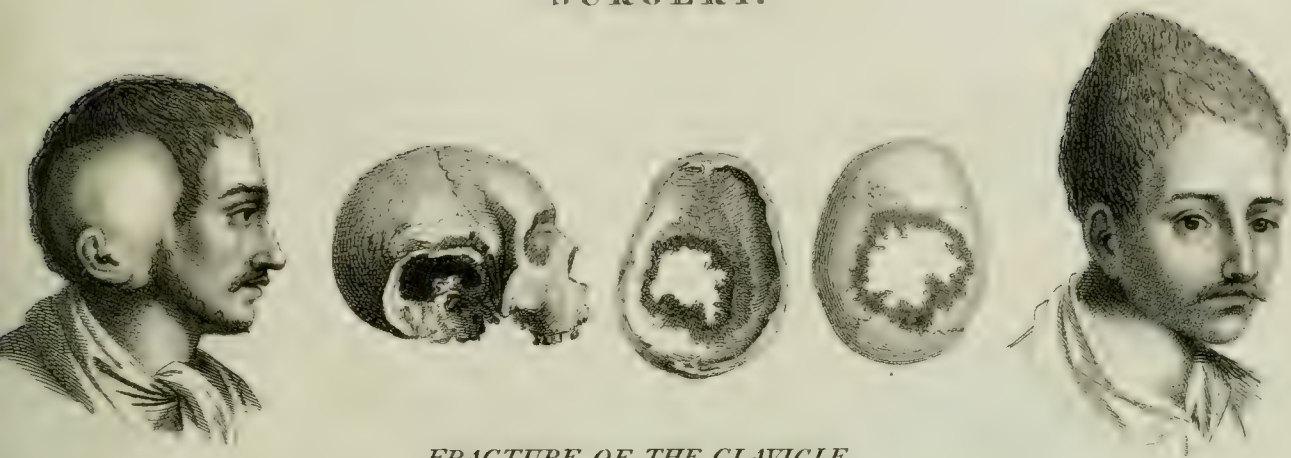

FRACTURE OF THE CLAVICLE.

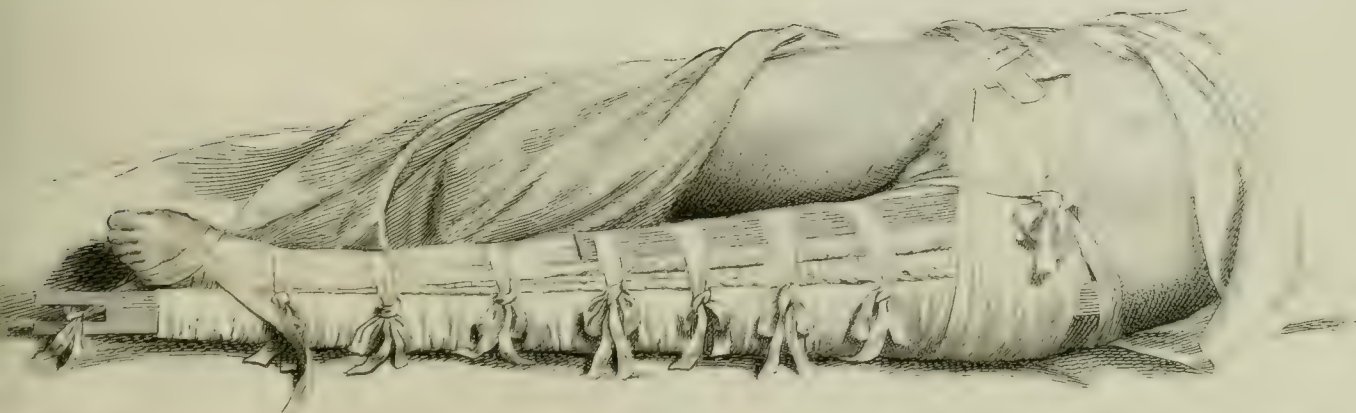
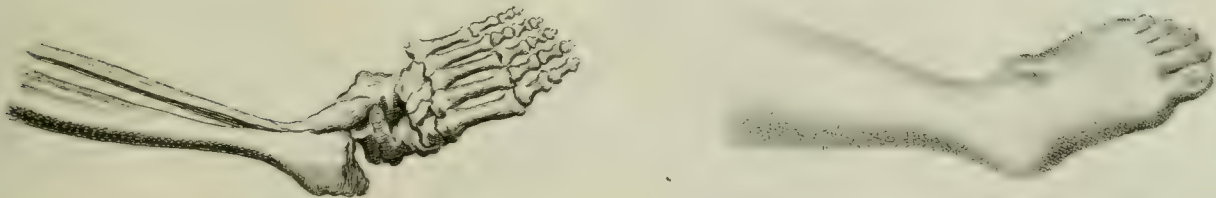

FRACTURE OF THE LEG.



SPLINTS.



BANDAGES.



Instruments for Lithotomy.

Fig. 1.

M^r Earle's Stone Breaker.

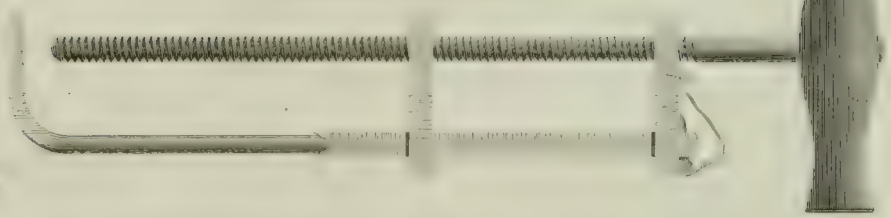

Fig. 3.

M^r Chas. Bell's Staff with the groove on the side.

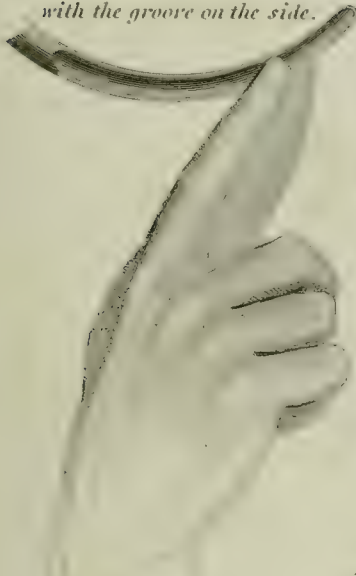

Fig. 2.

Scoop



Fig. 4.

M^r A. Burn's knife and Staff.

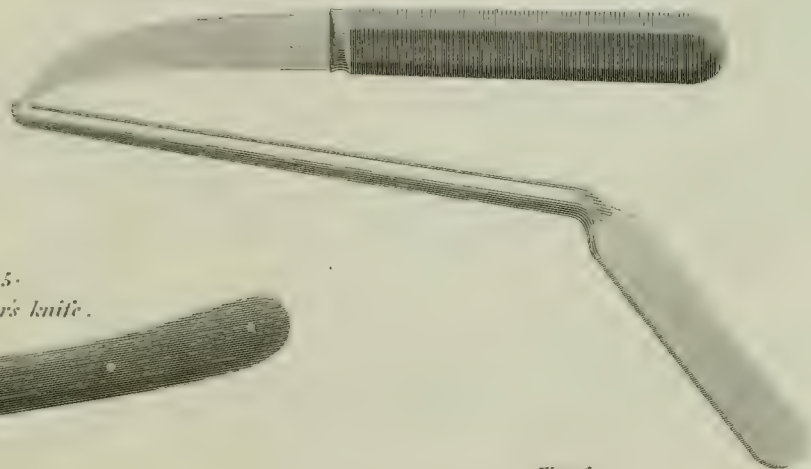

Fig. 5.

M^r Hunter's knife.

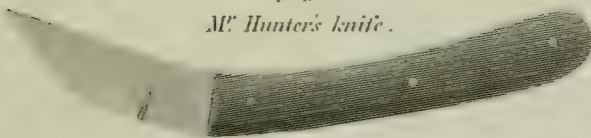

Fig. 6.

M^r A. Cooper's knife.



Fig. 7.

M^r Tho^s Blizard's knife.



Fig. 8.

Erere Cosmés Bistoire Caché.



Fig. 9.

Screw, by which the distance, to which the blade shall move out may be best regulated.

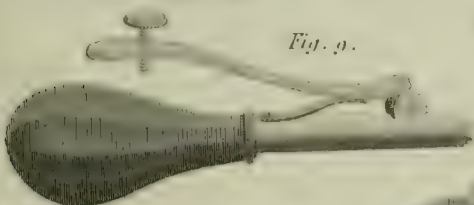

SURGERY.

Instruments for Lithotomy.

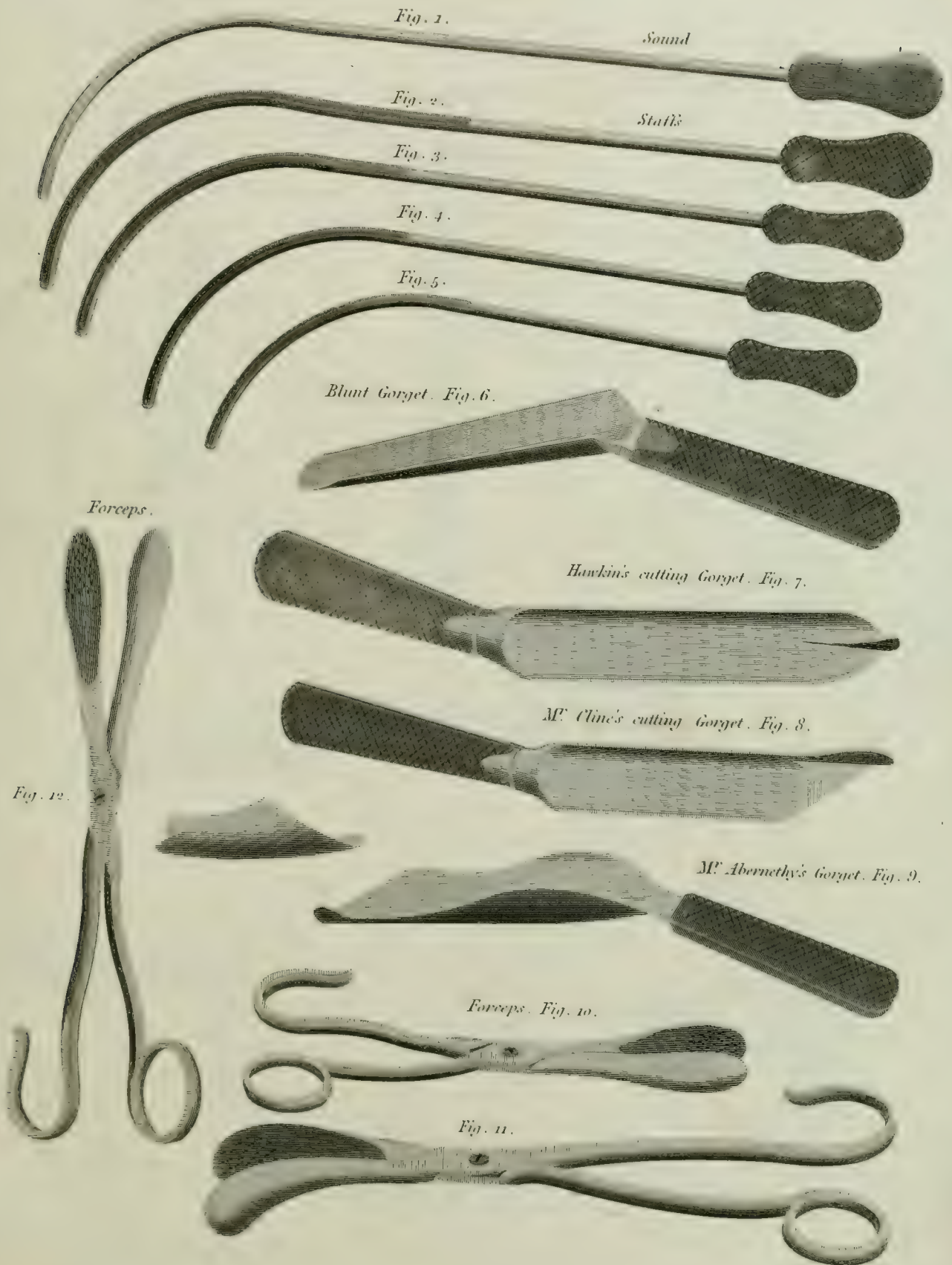

Fig. 1.

Sound

Fig. 2.

Stalis

Fig. 3.

Fig. 4.

Fig. 5.

Blunt Gorget. Fig. 6.

Hawkin's cutting Gorget. Fig. 7.

Mr. Cline's cutting Gorget. Fig. 8.

Mr. Abernethy's Gorget. Fig. 9.

Forceps. Fig. 10.

Fig. 11.

Forceps.

Fig. 12.

TRIPOD ELEVATOR.

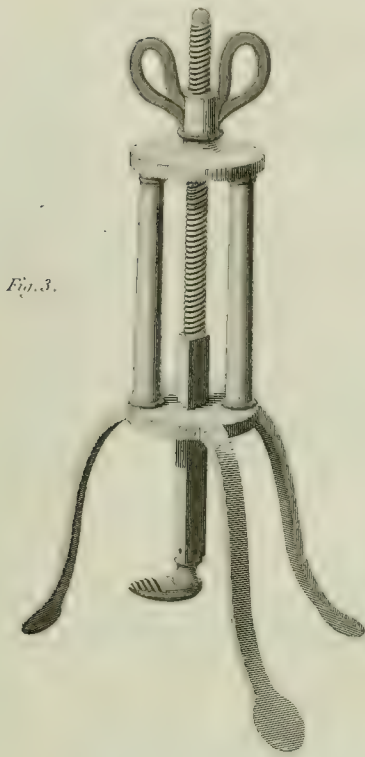
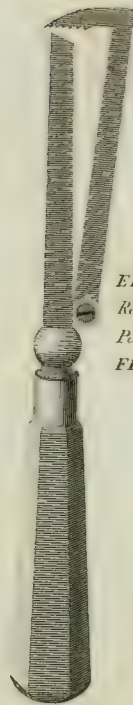

Fig. 2.



ELEVATOR for Raising Depressed Portions of a FRACTURED SKULL.

M^r RODMANS TREPPANNING INSTRUMENT.

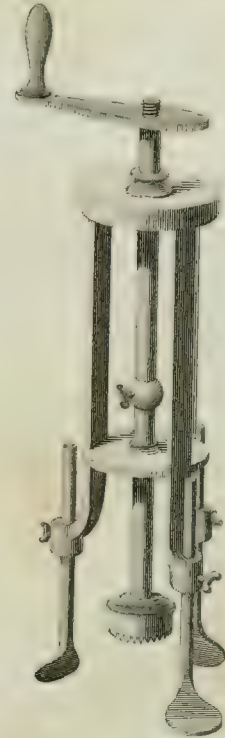

Fig. 1.

ELEVATOR of L.L. PETIT as improved by M. LOUIS.

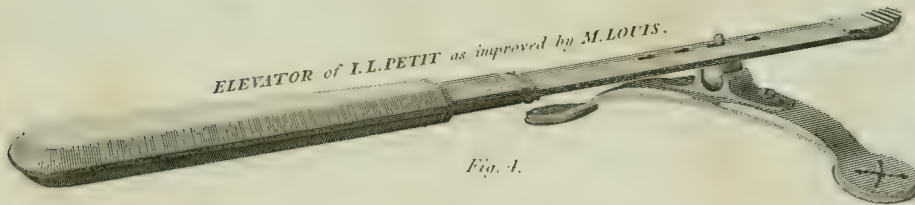
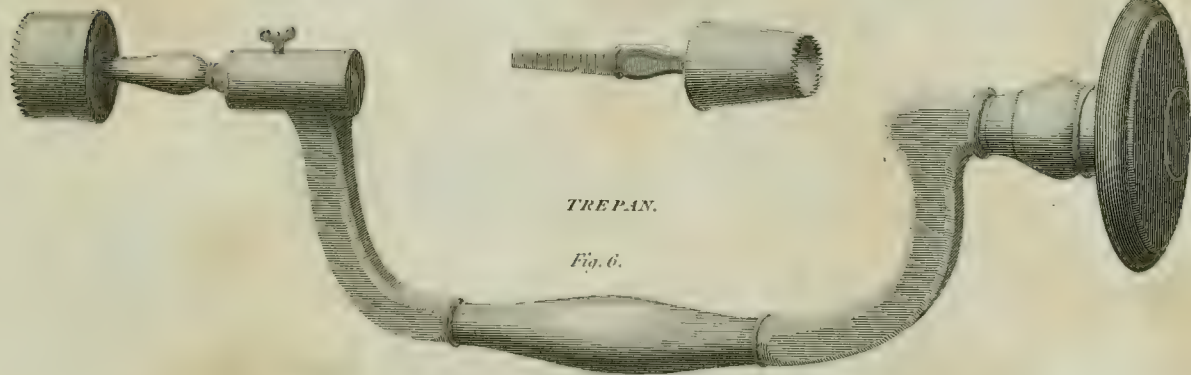

Fig. 4.

Fig. 5.

Old Conical Saw.



TREPAN.

Fig. 6.

TREPANNING INSTRUMENTS.

Fig. 1. Spring Forceps for Extracting the Circle of Bone, and Fragments.

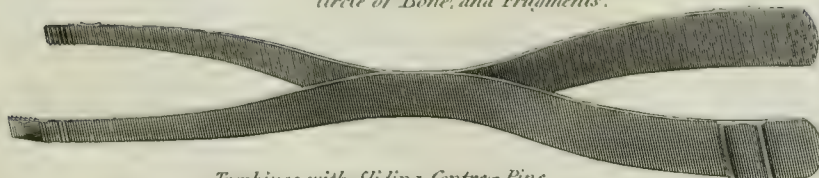

Trephines with Sliding Centre-Pins as made by Savigny.

Fig. 2.

Fig. 3.

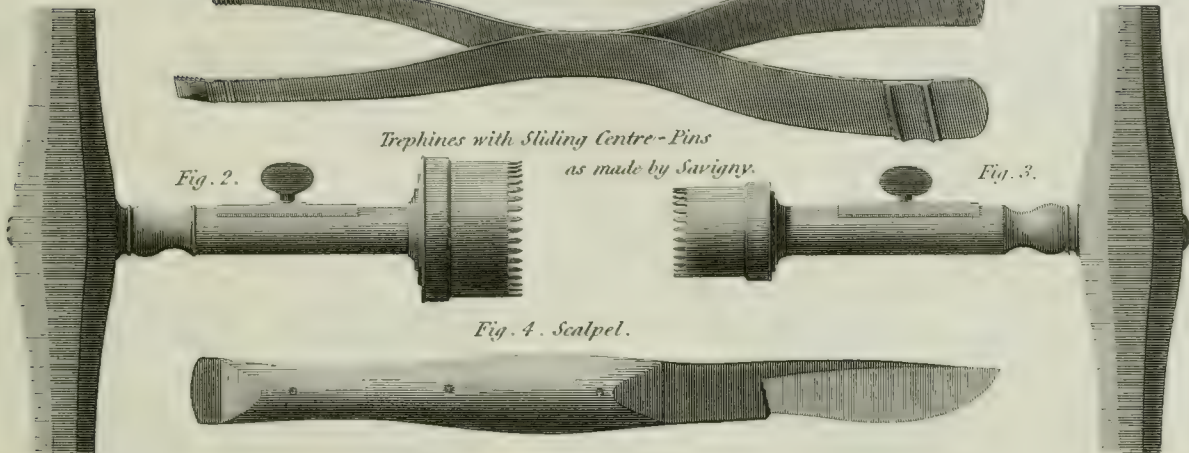

Fig. 4. Scalpel.

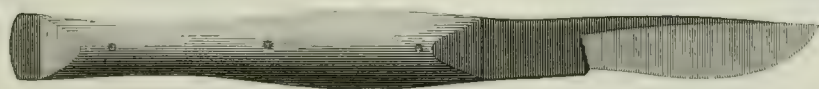

Fig. 5. Common Elevator.



Fig. 6. Mr. Hey's Saws with Curved Edges.

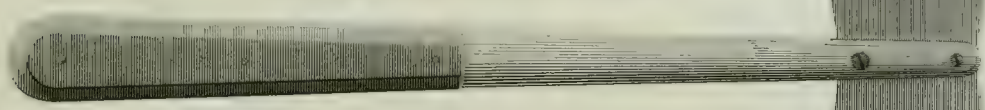

Fig. 7. Lenticular.



Fig. 8. Raspatory.



Fig. 9. Mr. Hey's small straight Saw.

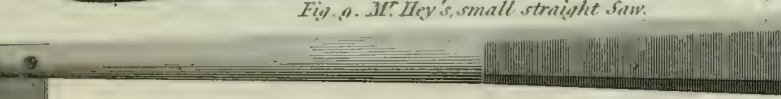

Brush for cleaning the Teeth of the Trephine.

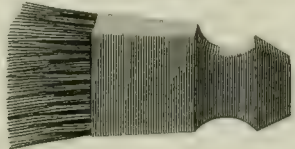

Fig. 11.

Fig. 12. Mr. Hey's large straight Saw.

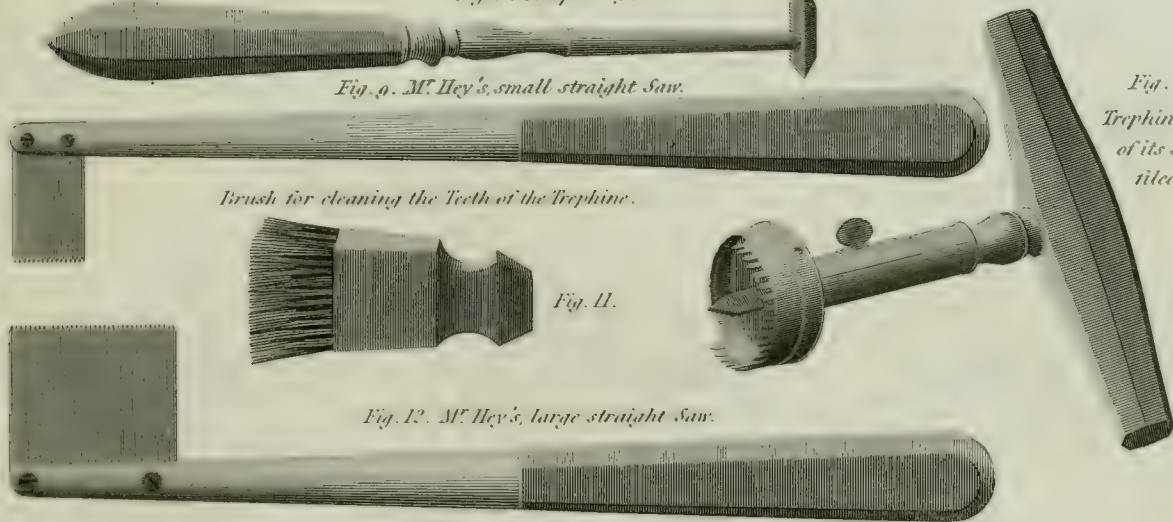

Fig. 13.

Centre-pin and Screw.



Fig. 10. Trephine with half of its Sawing Edge filed away.

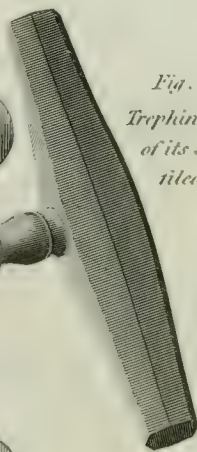

Fig. 1.

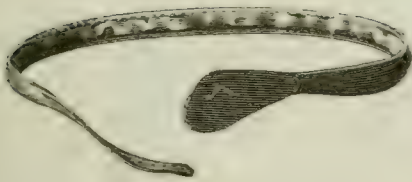

Fig. 2.

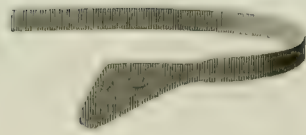

Fig. 3.

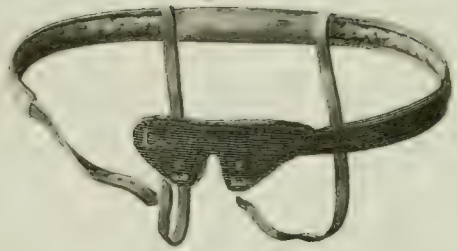
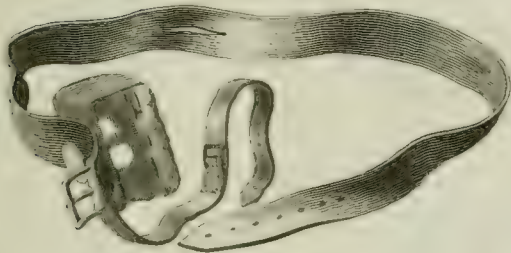

Fig. 4. Dr. Hulme's Palm Truss.



M. Whitford's Fig. 5.



Fig. 6.

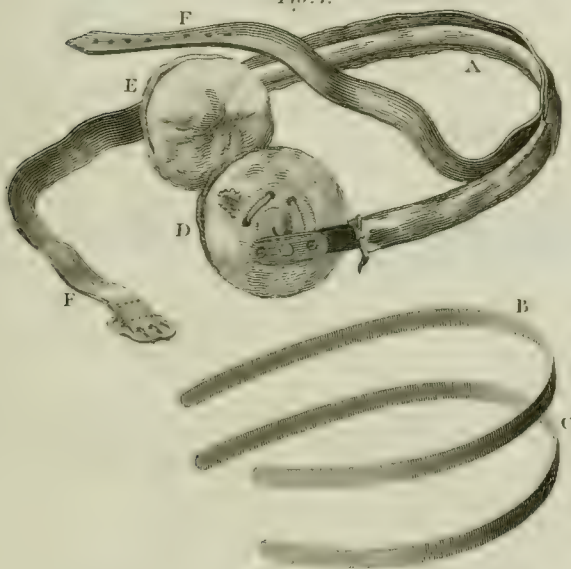

M. Salmon's Patent.

Fig. 7.



M. Morrison's for Exomphalos Fig. 8.

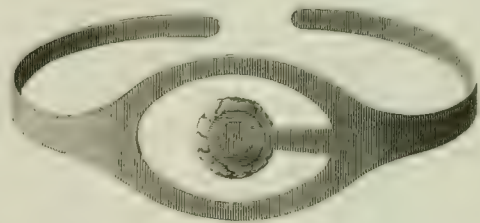

Fig. 10.



M. England's Fig. 9.

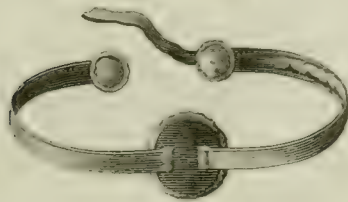
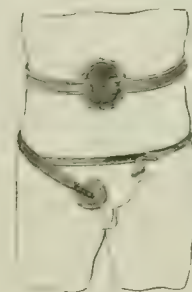
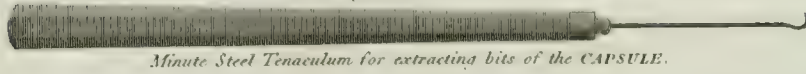

Fig. 11.



Instruments for the Extraction of the CATARACT,
and for the Fistula Lachrymalis.

Fig 1



Minute Steel Tenaculum for extracting bits of the CAPSULE.

Fig. 2.

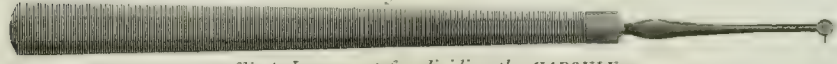

Cline's Instrument for dividing the CAPSULE.

Fig 4.

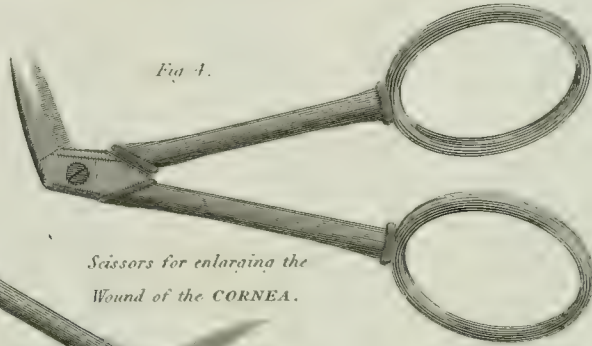

Scissors for enlarging the
Wound of the CORNEA.

Fig 5.

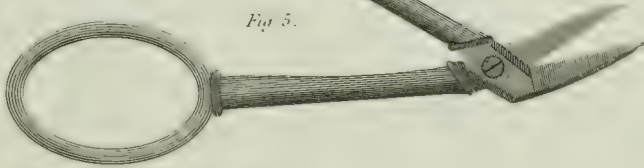
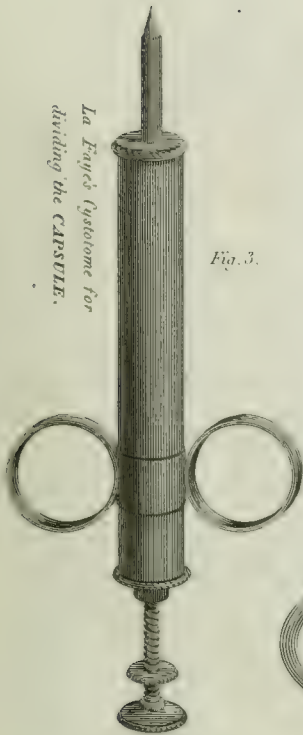
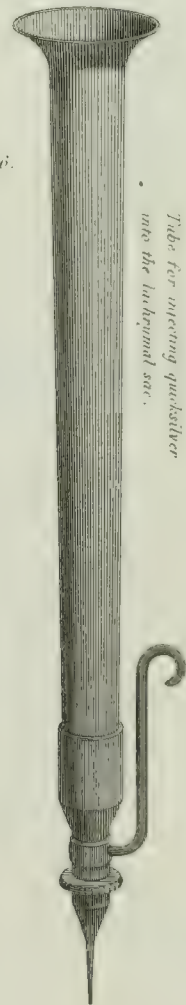

Fig. 3.



La Foye's Cystotome for
dividing the CAPSULE.

Fig. 6.



Tube for entering quiescent
into the lachrymal sac.

Axel's Syringe and Pipes.

Fig. 7.



Fig 8.



Fig. 9



Fig. 10.



Wathen's Tubes.

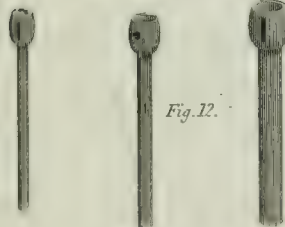

Fig. 12.

Ware's Stiles.

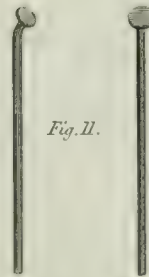
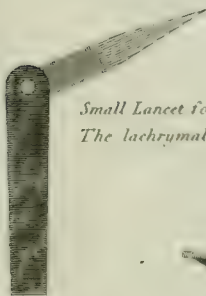

Fig. 11.

Small Lancet for puncturing
The lachrymal sac.

Fig 13



Gibson's Knife for LITHOTOMY.

Fig. 14.



Instruments for Couching and the Extraction of the Cataract.

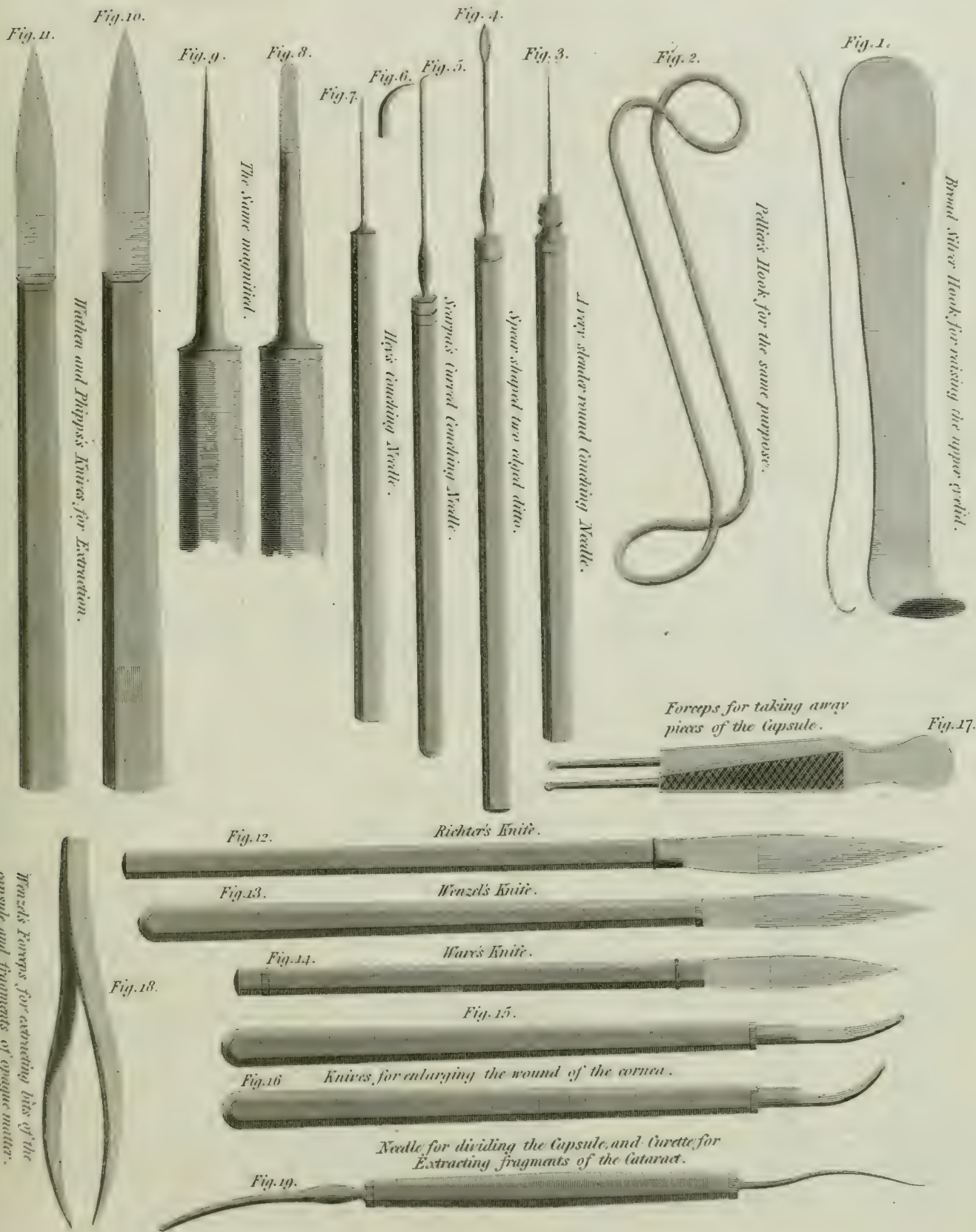

PROTRACTOR.

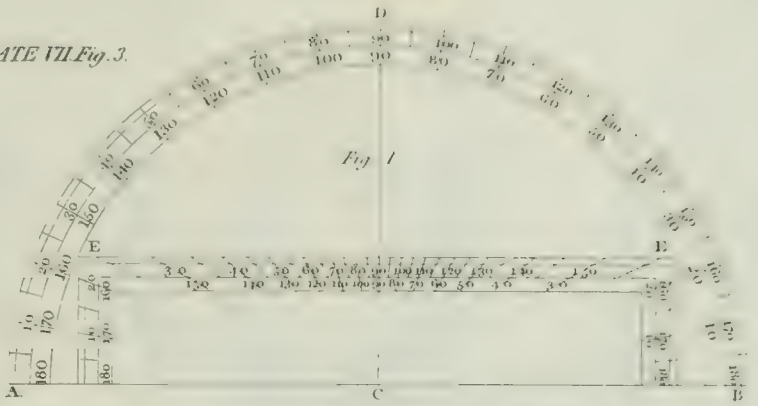

For Fig 2, see PLATE VII Fig. 3.

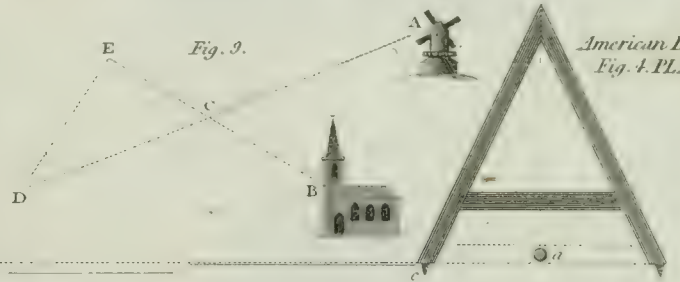
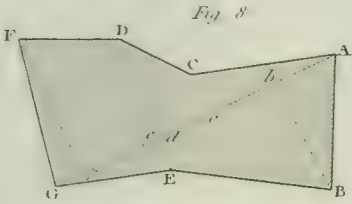
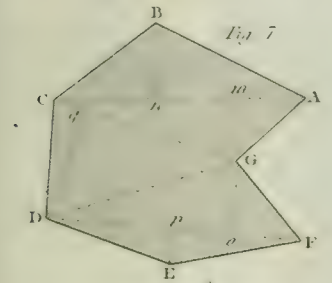
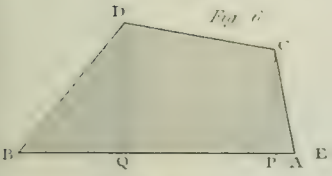
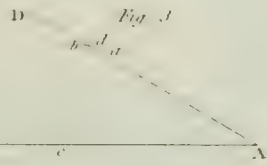
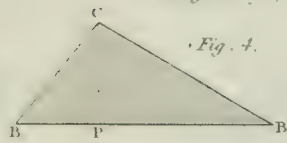
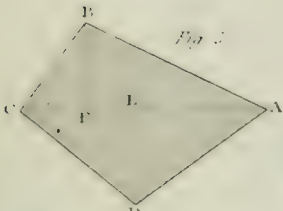

LEVEL

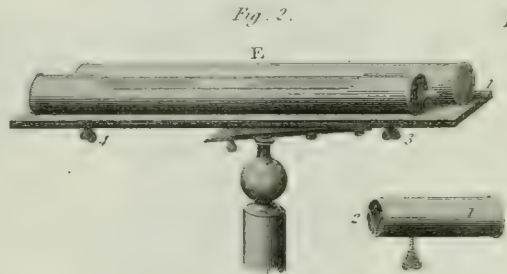
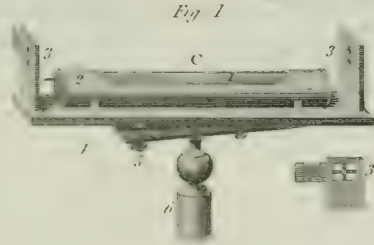
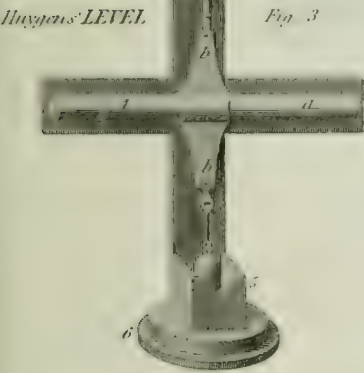
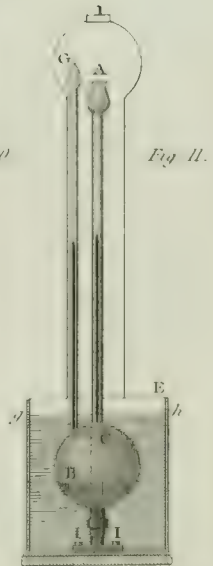
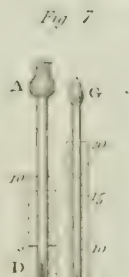

PLATE VI.

Desaguliers' LEVEL.



Watering LEVEL.

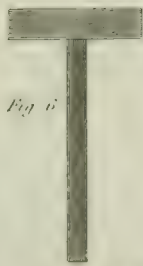
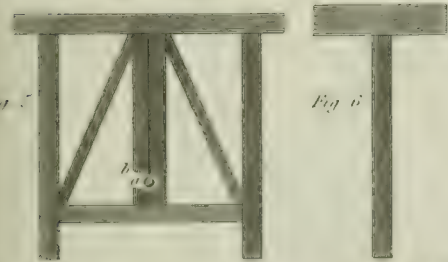
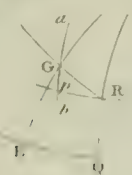

Fig. 10. PLATE I.



Convergency of MERIDIANS.

CIRCUMFERENTOR

Fig 1

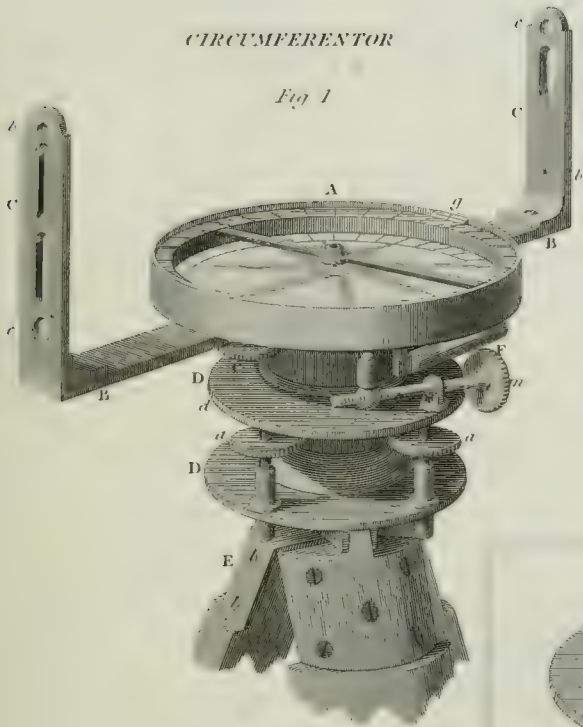

CROSS

Fig 1

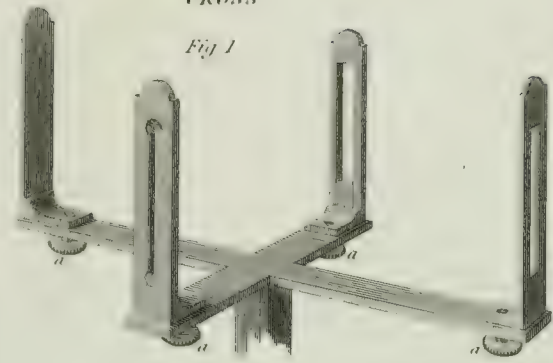

Fig 2.



Fig 5.

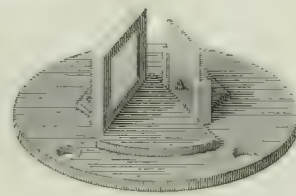

Fig 2

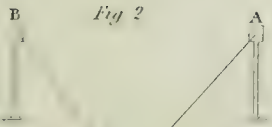

Fig 4

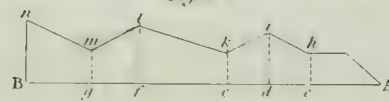

Fig 3.

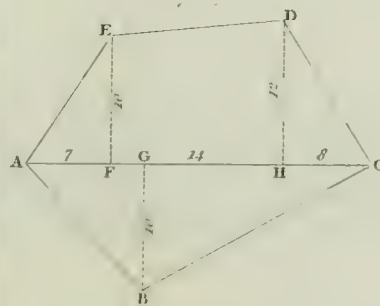

Fig 6.

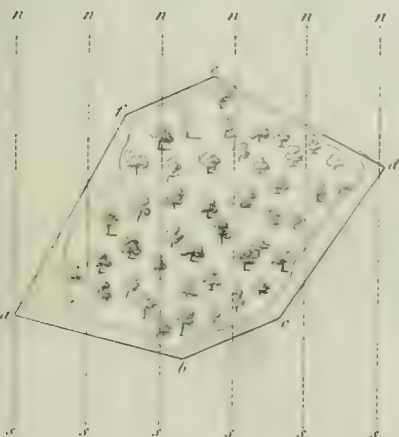
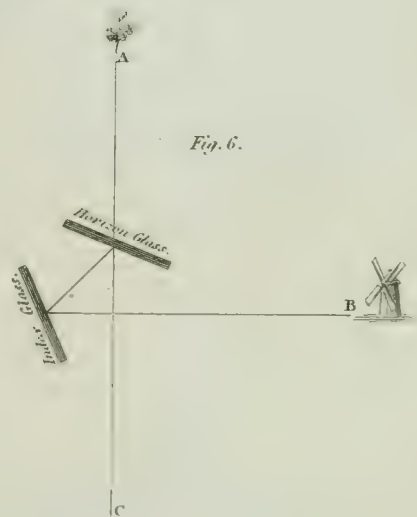

Fig 3

SURVEYING.

LEVELS.

by Mr Ramsden.

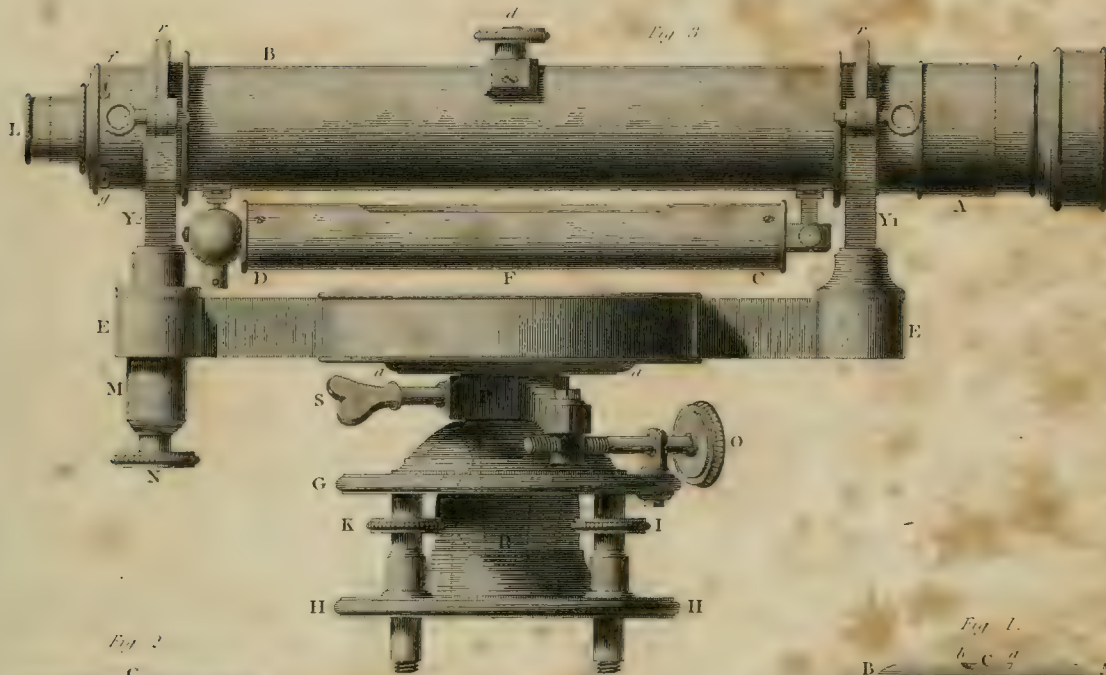

Fig. 2

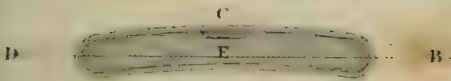
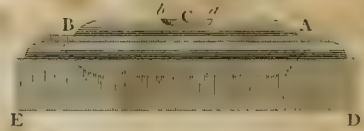

Fig. 1



Mr Troughton's

Fig. 1

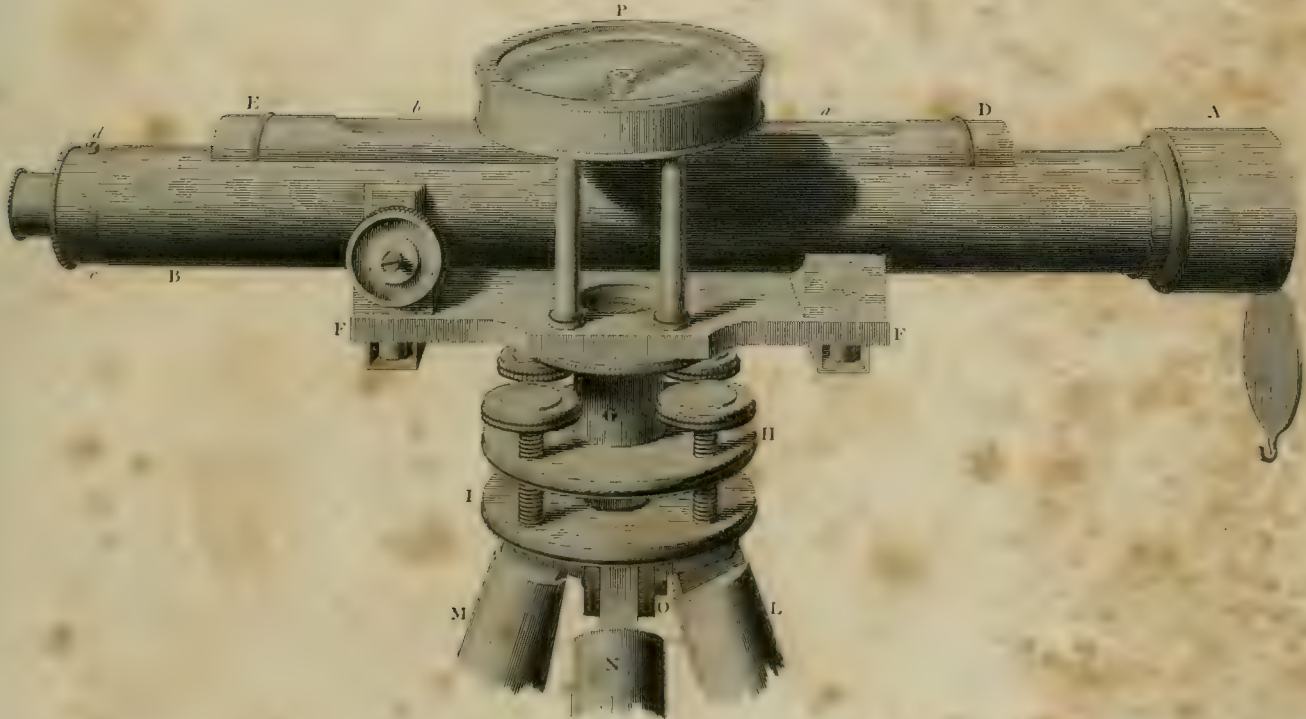



Fig. 1.

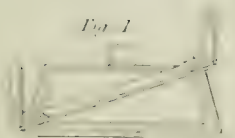

Fig. 2.

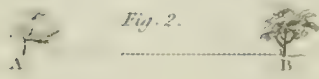

Fig. 3.



Fig. 4.

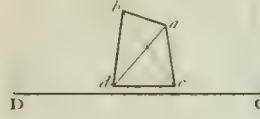
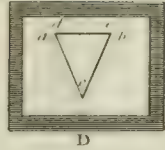

Fig. 6.

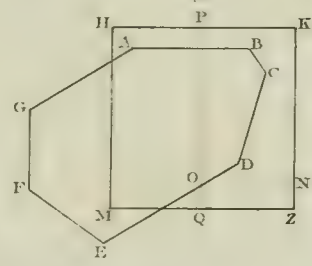

Fig. 12.

Fig. 7.

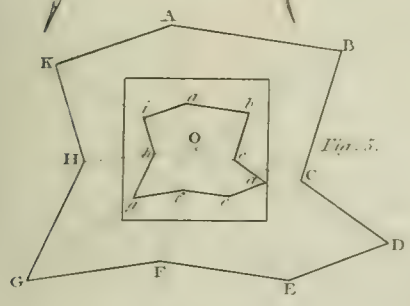
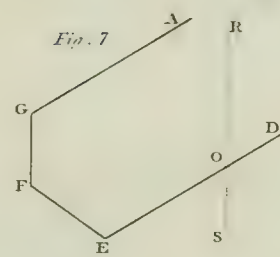

Fig. 5.

PERAMBULATOR

Fig. 10.

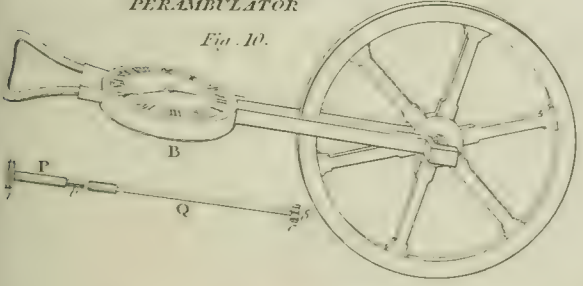
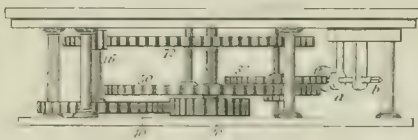
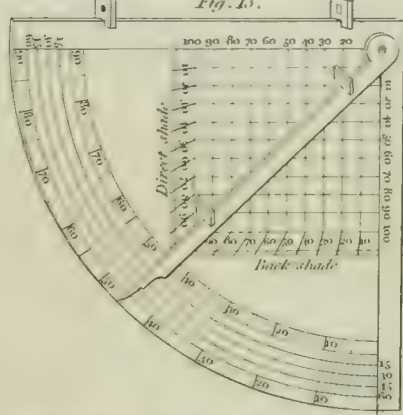

Fig. 9.



QUADRANT

Fig. 13.



PLOTTING SCALE.

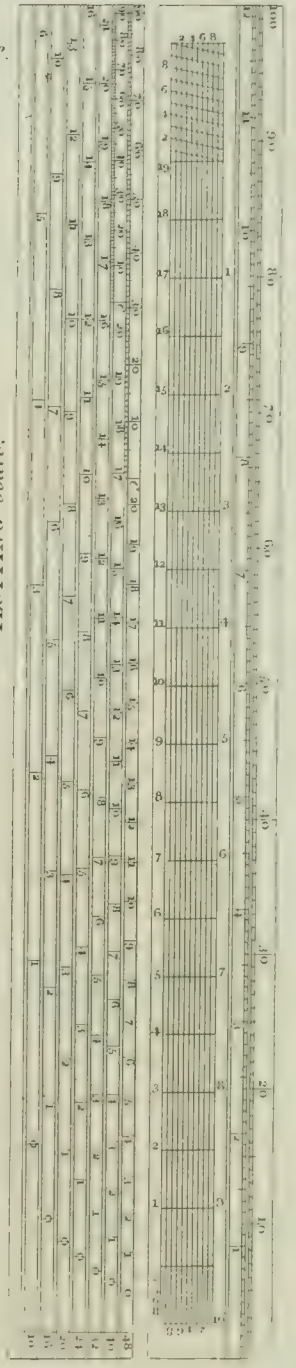

PLOTTING

Fig. 11.

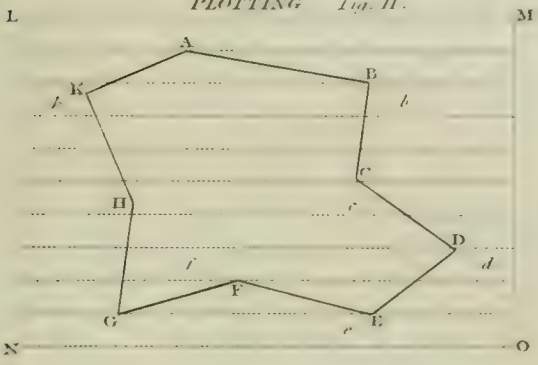

Carpenter's R U L E.

Fig. 11.

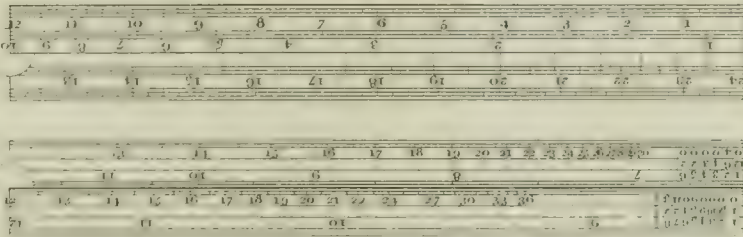
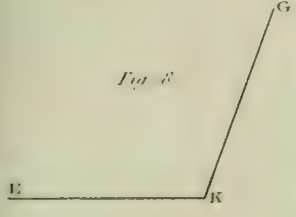
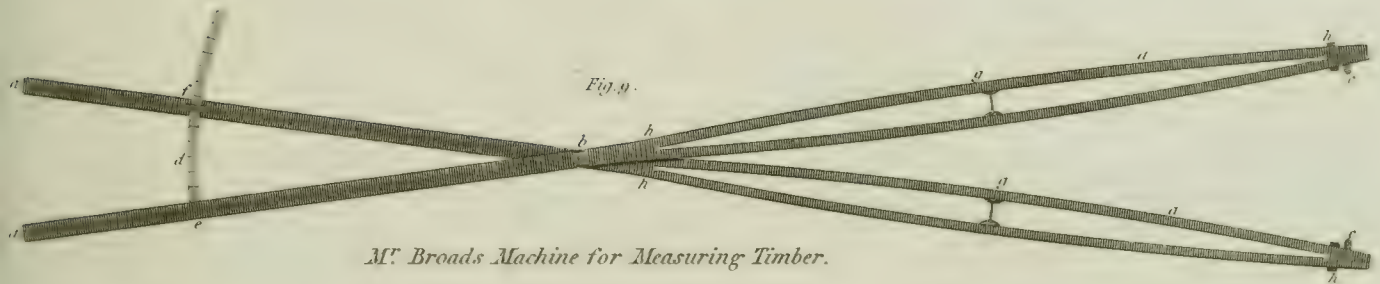
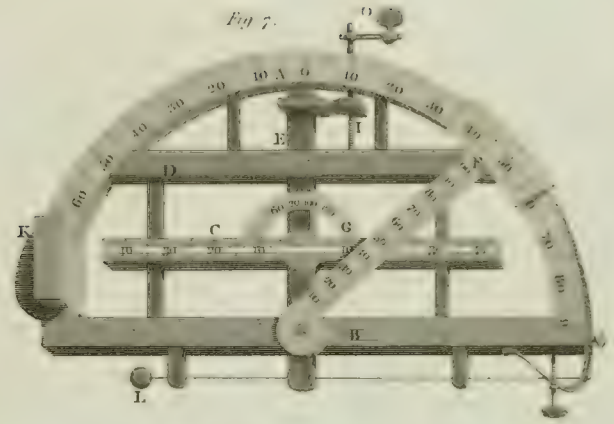
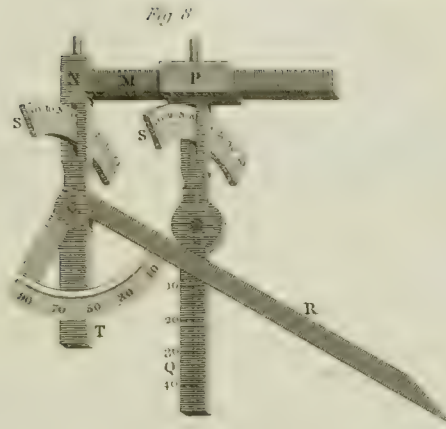

Fig. 3.



SURVEYING.
DENDROMETERS.



Mr. Broads Machine for Measuring Timber.

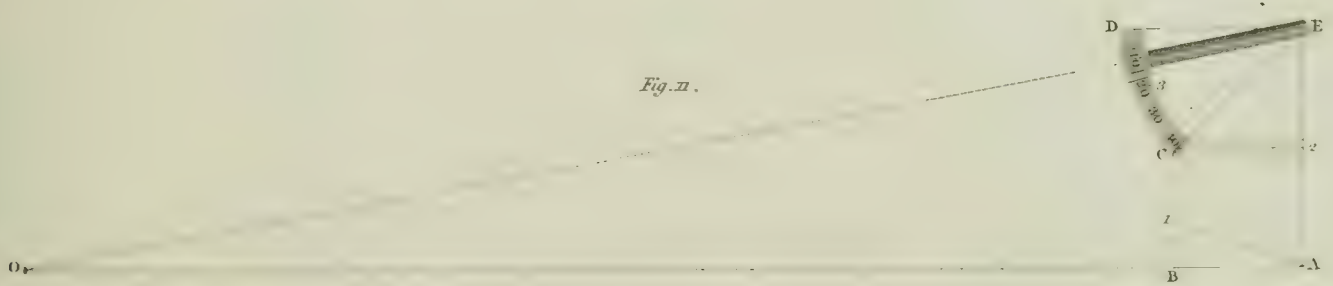

Fig. 11.

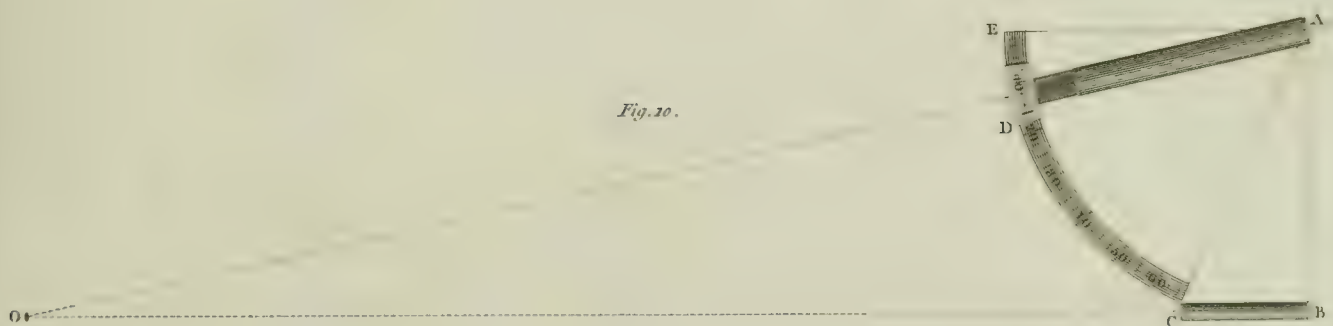

Fig. 10.

SURVEYING .
LEVELLING.

Fig. 1.

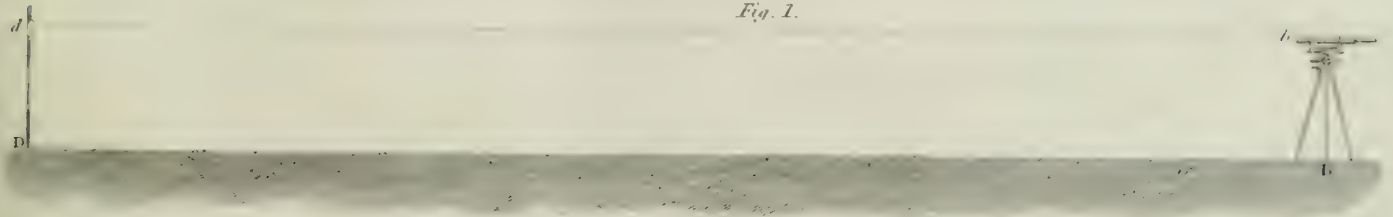

Fig. 2.

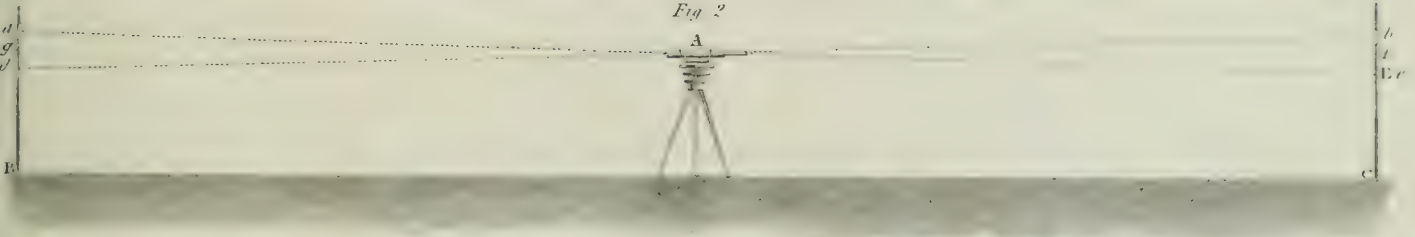

Fig. 4.

Fig. 5.

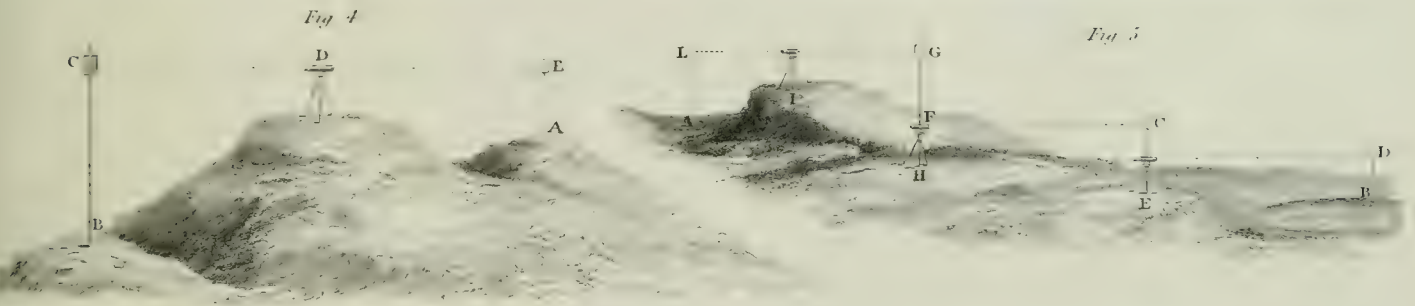

Fig. 7.

Fig. 8.

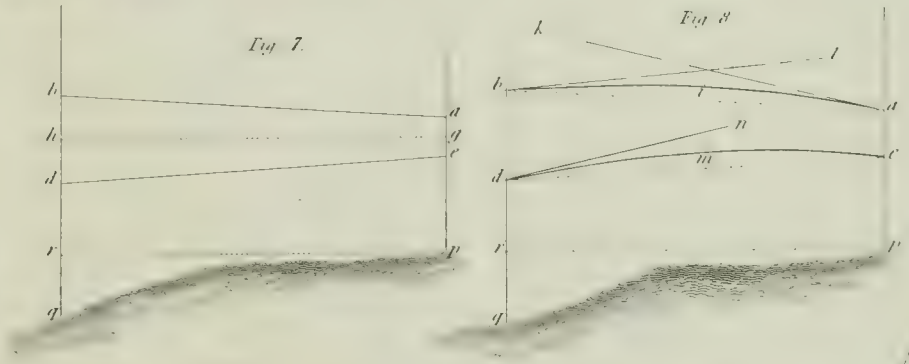

Fig. 6.

Fig. 9.

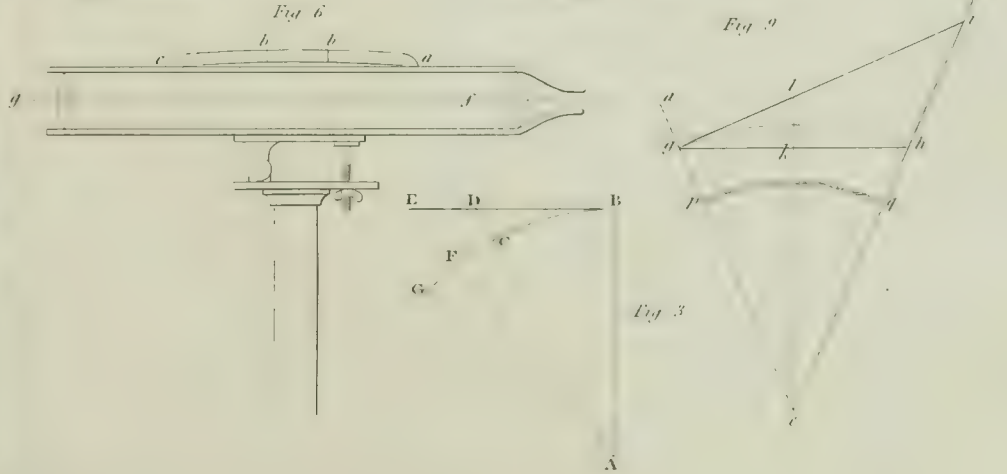
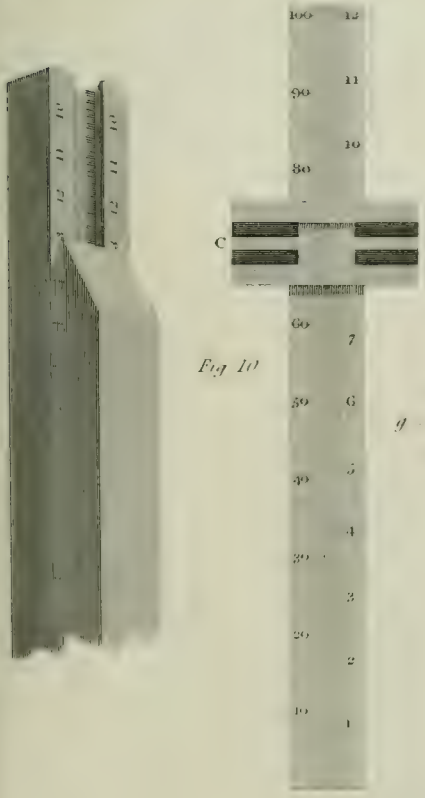

Fig. 10.



SURVEYING.

D^r Rogel's SLIDING Rule

Fig 9

SECTOR

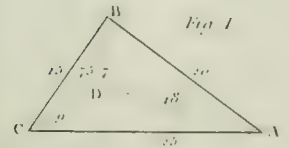
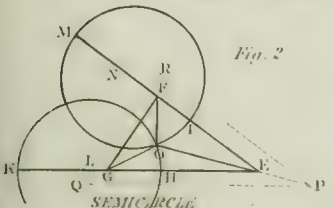

Fig 1

Fig 2



Coggshall's SLIDING Rule.

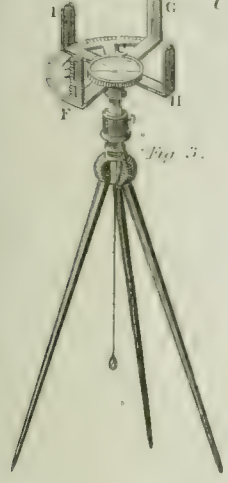

Fig 3.

Everard's SLIDING Rule

Fig 4.

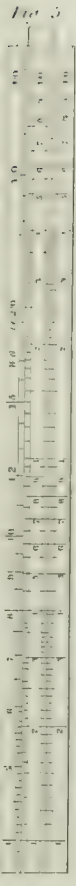
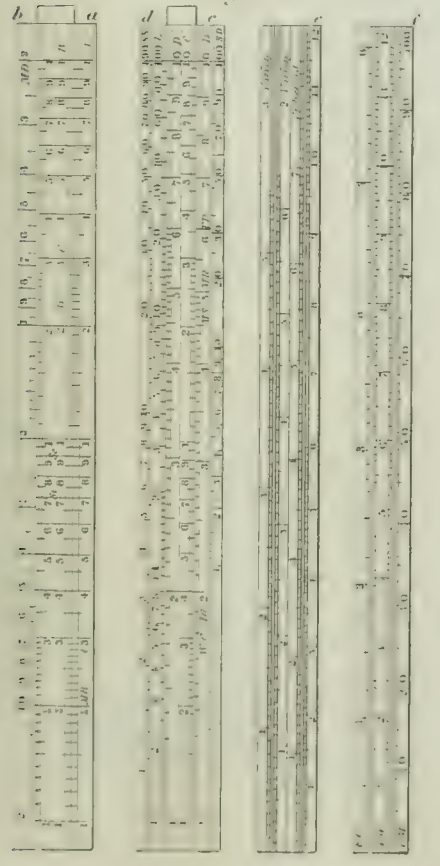

Fig 6

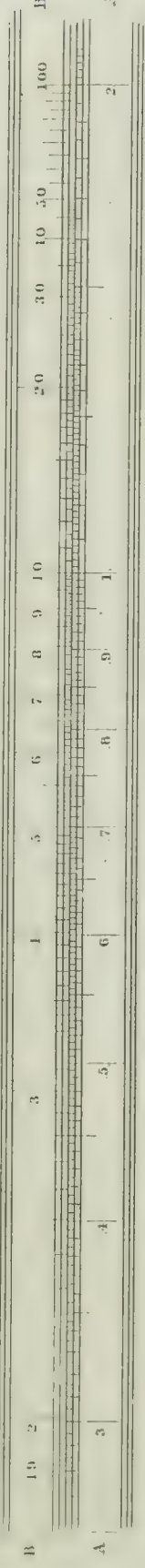

Fig 7

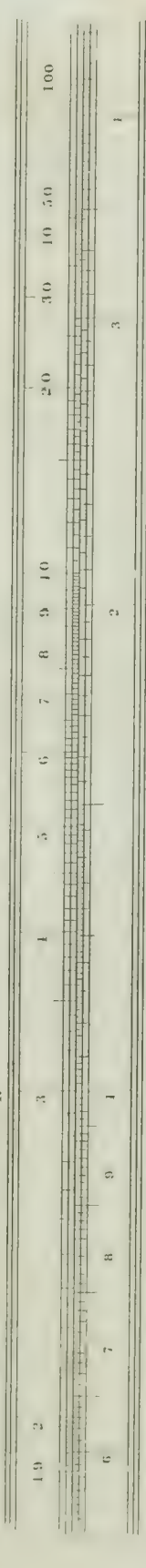
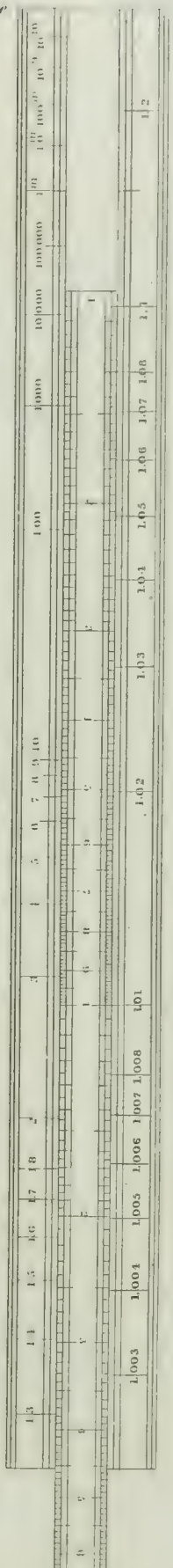
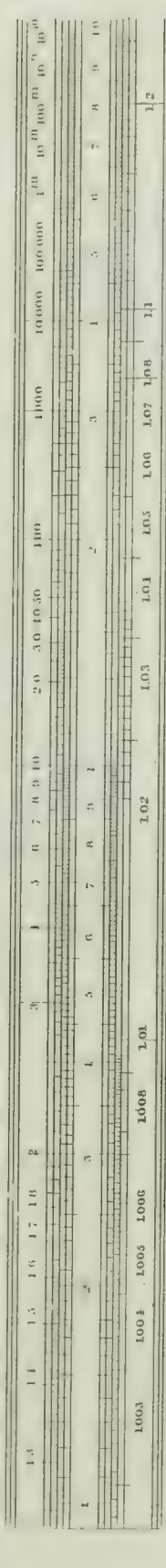
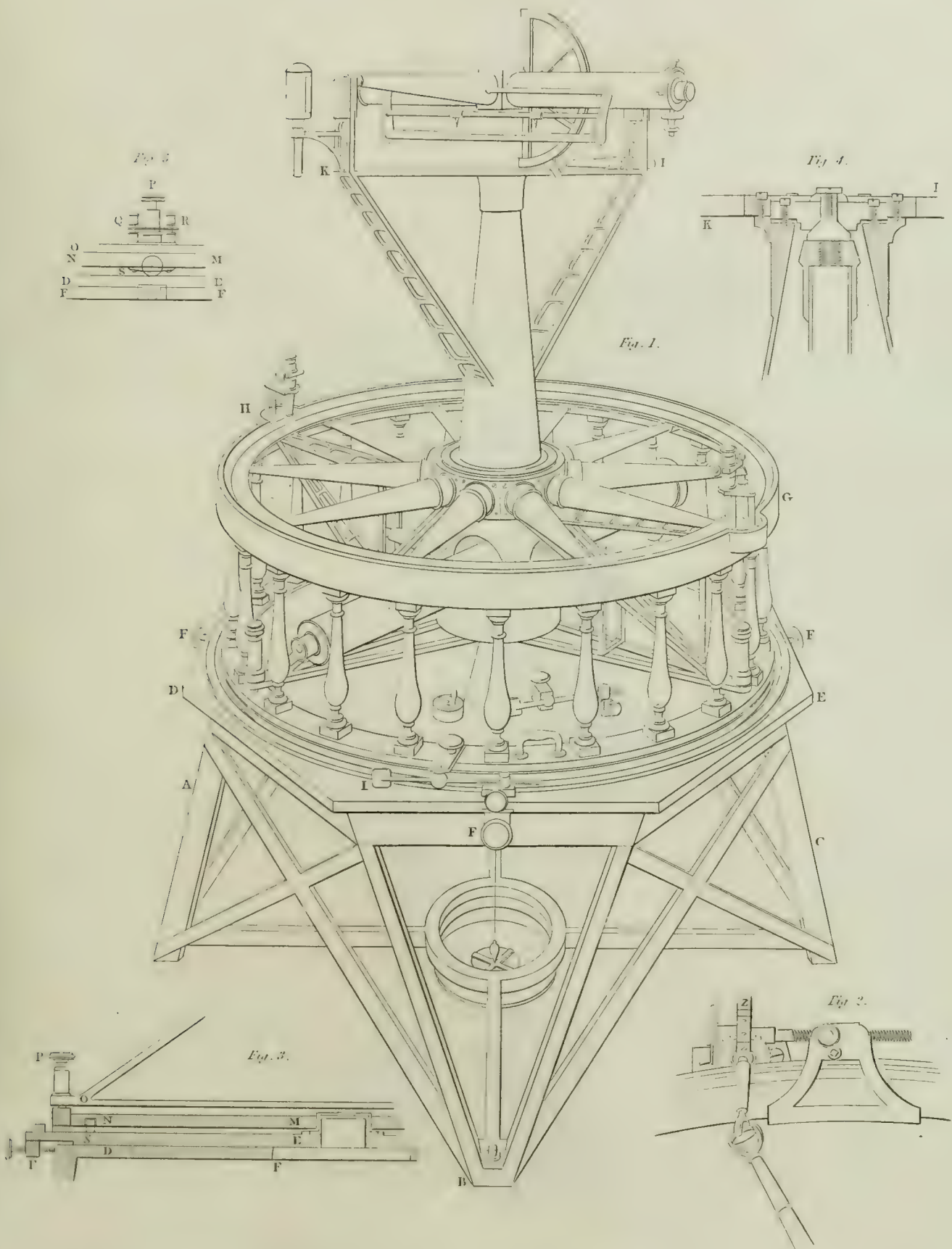

Fig 8



Grand THEODOLITE by Ramsden.



SURVEYING.

Portable THEODOLITE by Troughton.

PLATE IV.

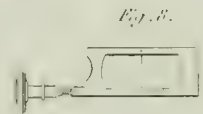
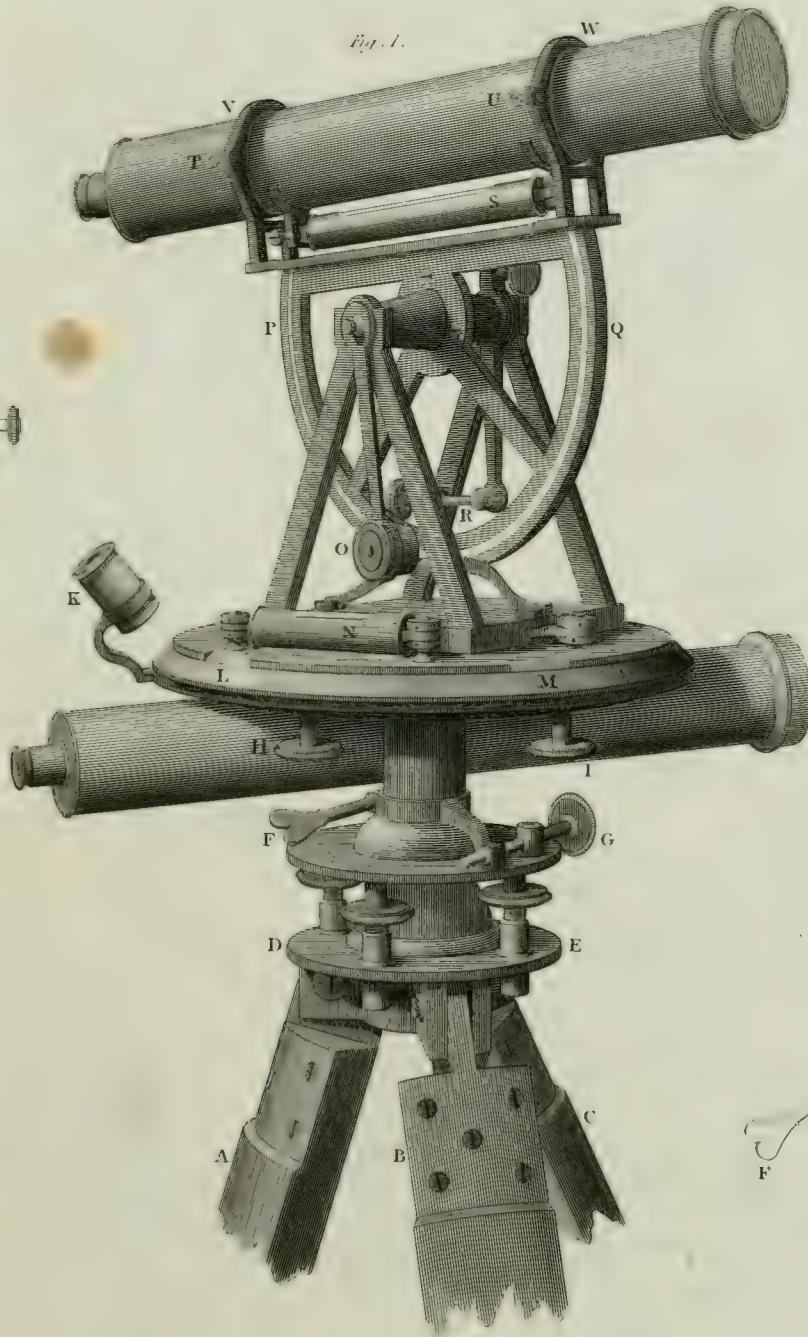
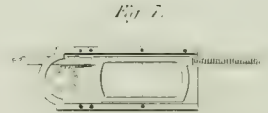
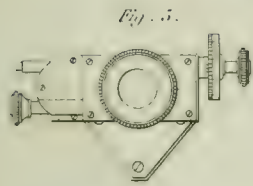
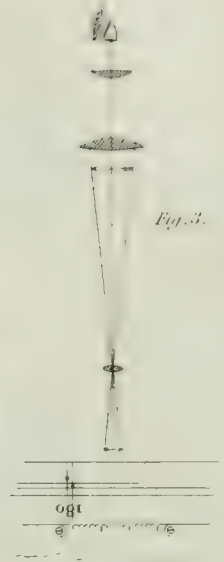
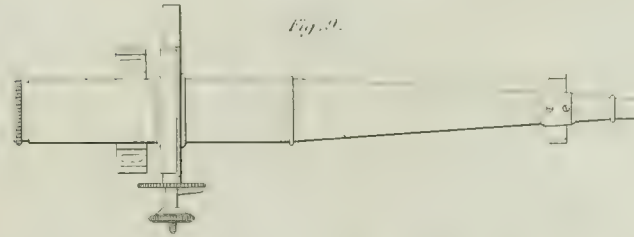
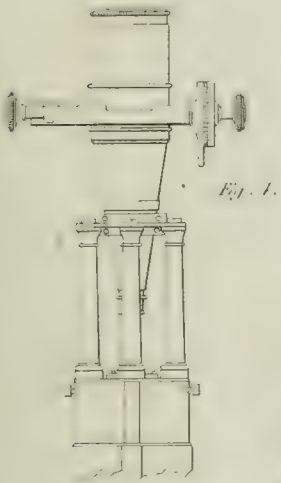

TELEGRAPH

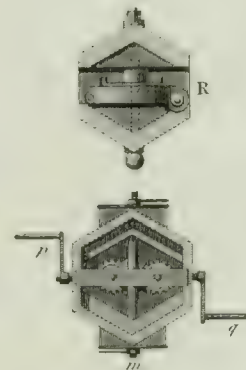
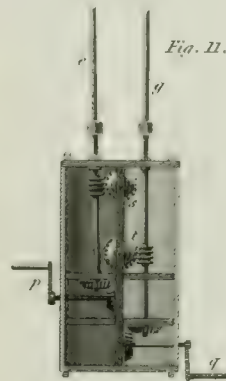
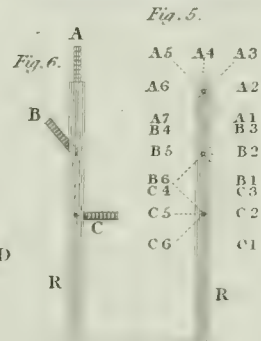
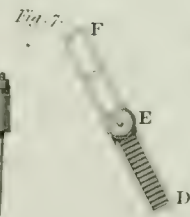
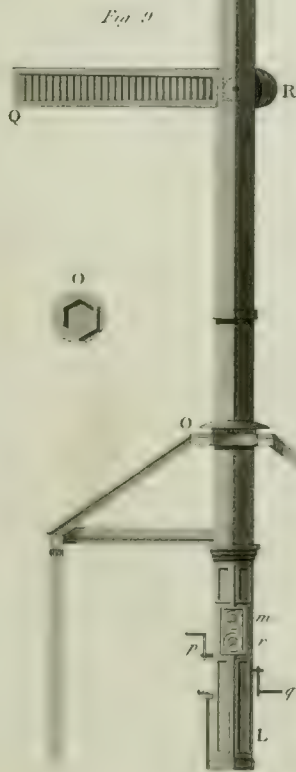
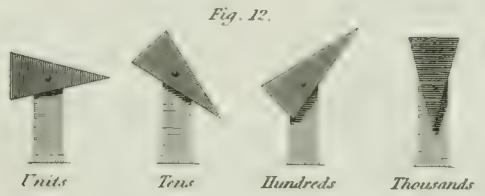
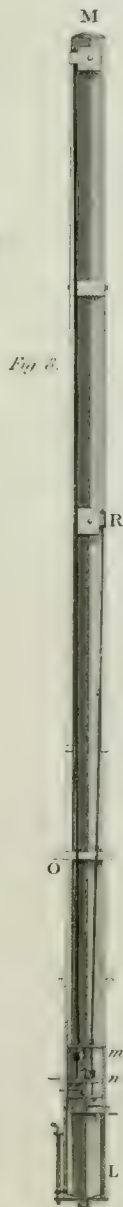
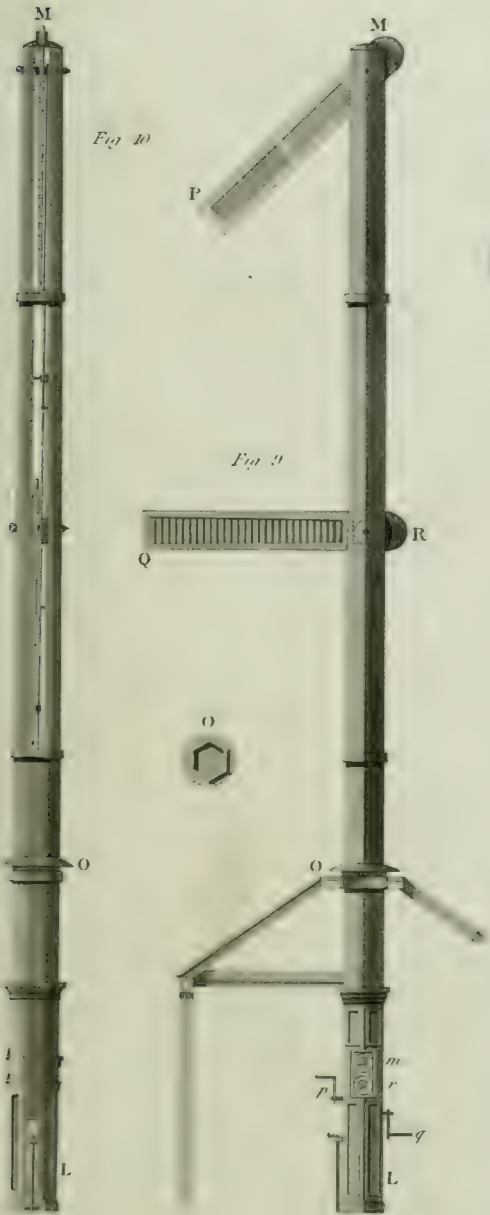
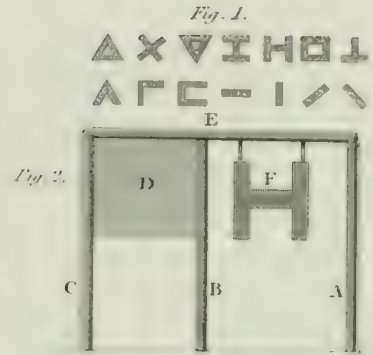
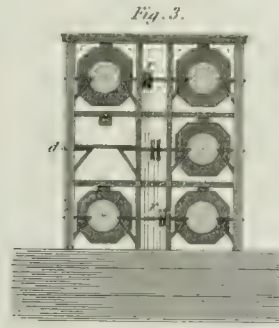
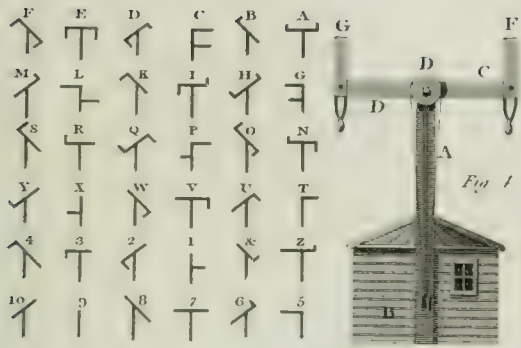
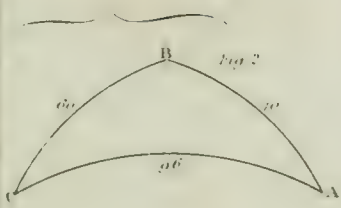
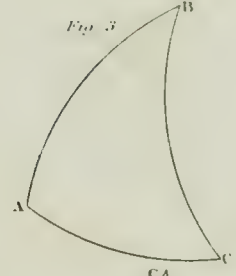

Fig 1



PART



SECANT & SINE

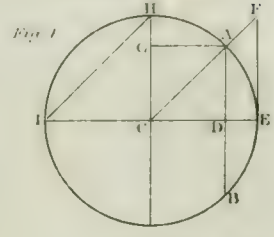

Fig 5

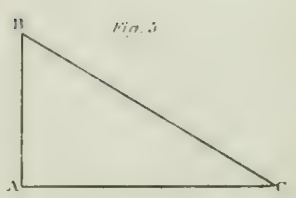

Fig 6

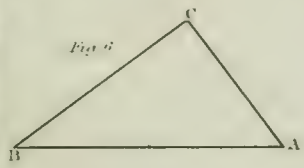
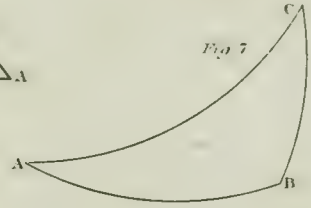

Fig 7



ARITHMETIC

OF SINES

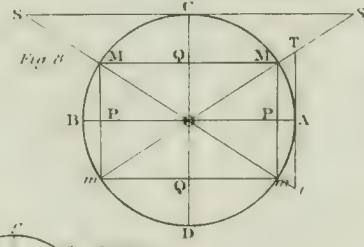

Fig 9

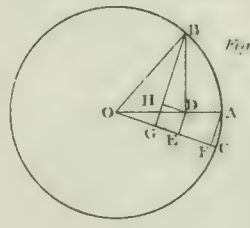

Fig 10

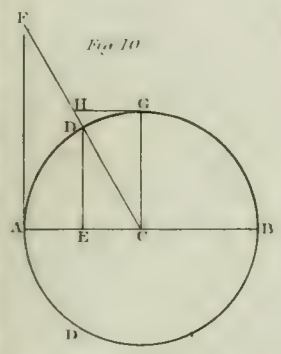
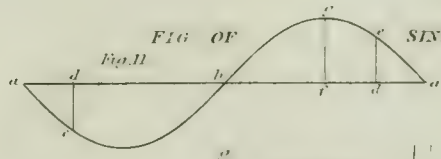

FIG OF SINES

Fig 11



COSINES

Fig 12

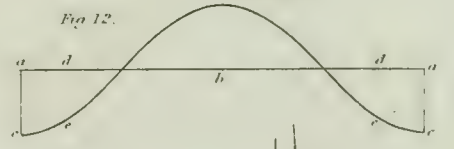

VERSED SINES

Fig 13

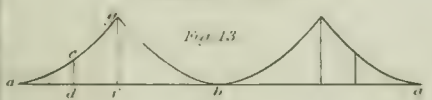

TANGENTS

Fig 14

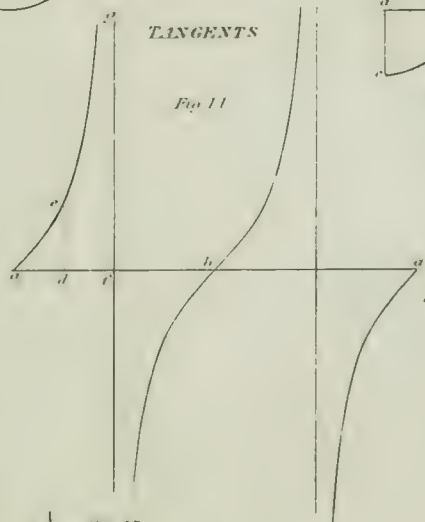

COTANGENTS

Fig 15

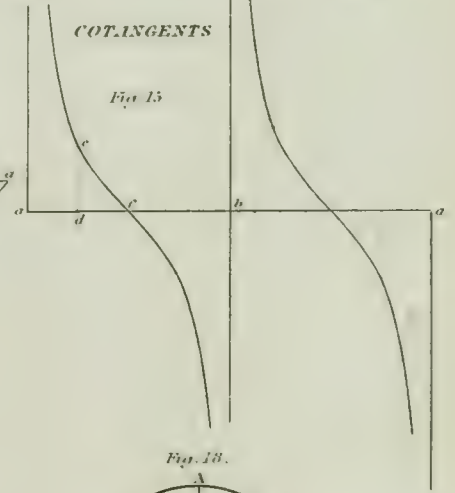

SECANTS

Fig 16

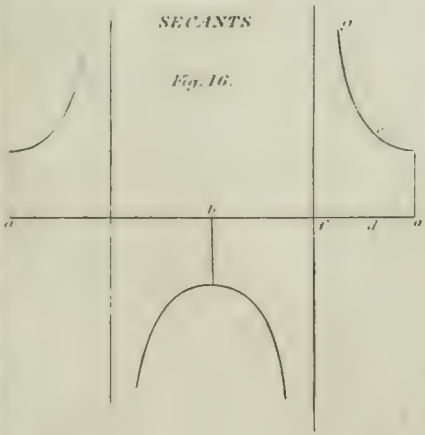

COSECANTS

Fig 17

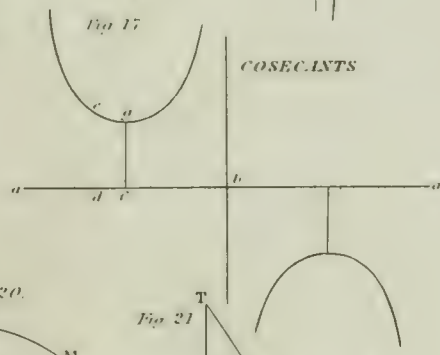

Fig 18

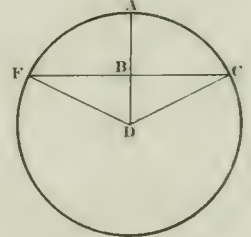

Fig 19

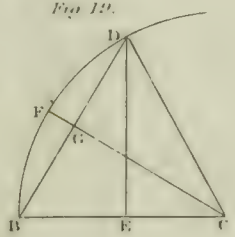

Fig 20

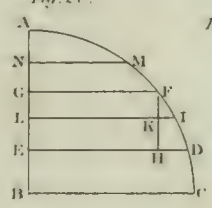

Fig 21

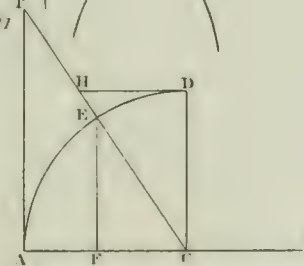
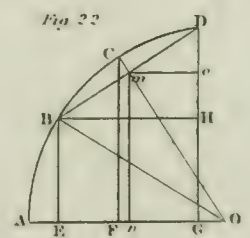
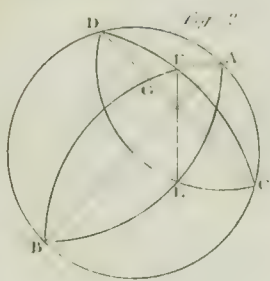
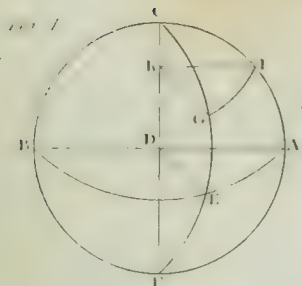

Fig 22



Spherical Angle



Spherical Triangle

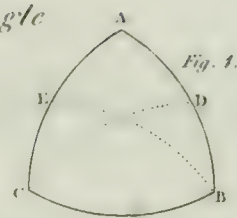
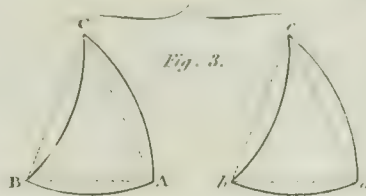

Fig. 5

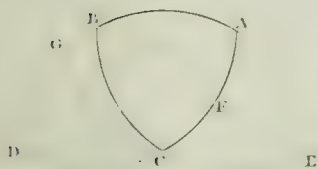

Fig. 6

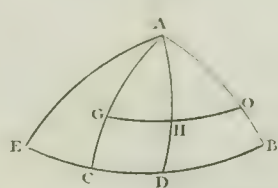

Fig. 7

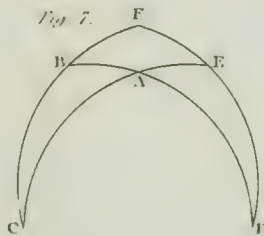
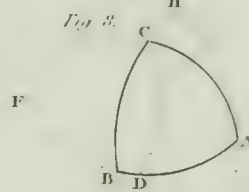

Fig. 8



SPHERICS

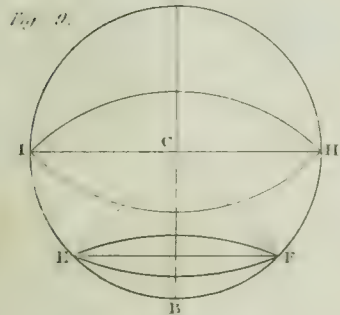

Fig. 10

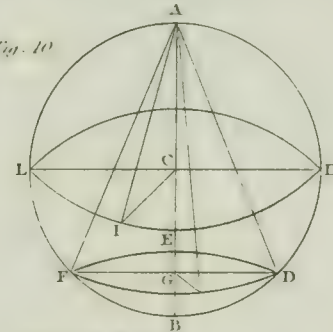
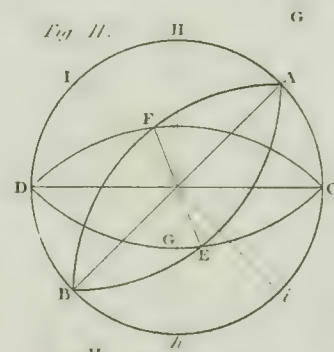

Fig. 11



TANGENT

TRIGONOMETRY

Fig. 12

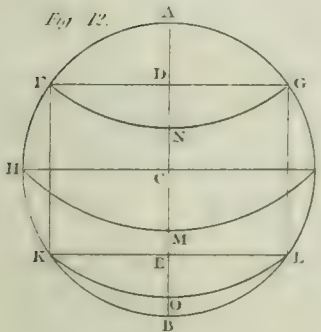

Fig. 13

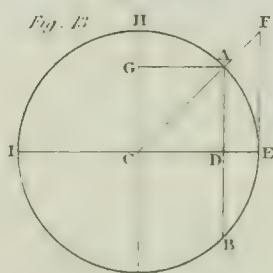

Fig. 14

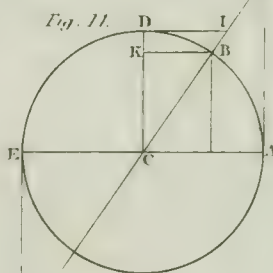

Fig. 15

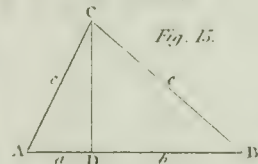

Fig. 16

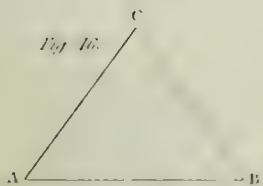

Fig. 17

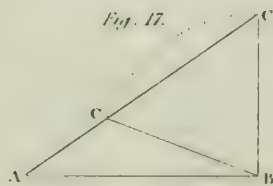

Fig. 18

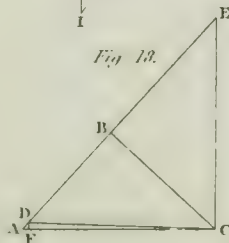

Fig. 19

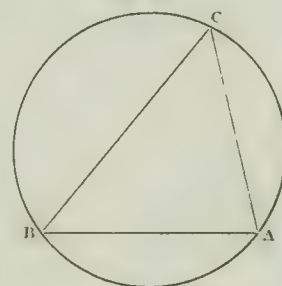

Fig. 20

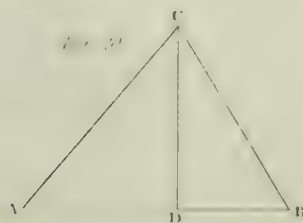

Fig. 21

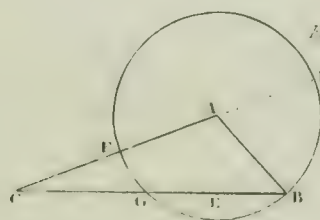
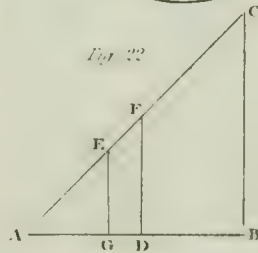
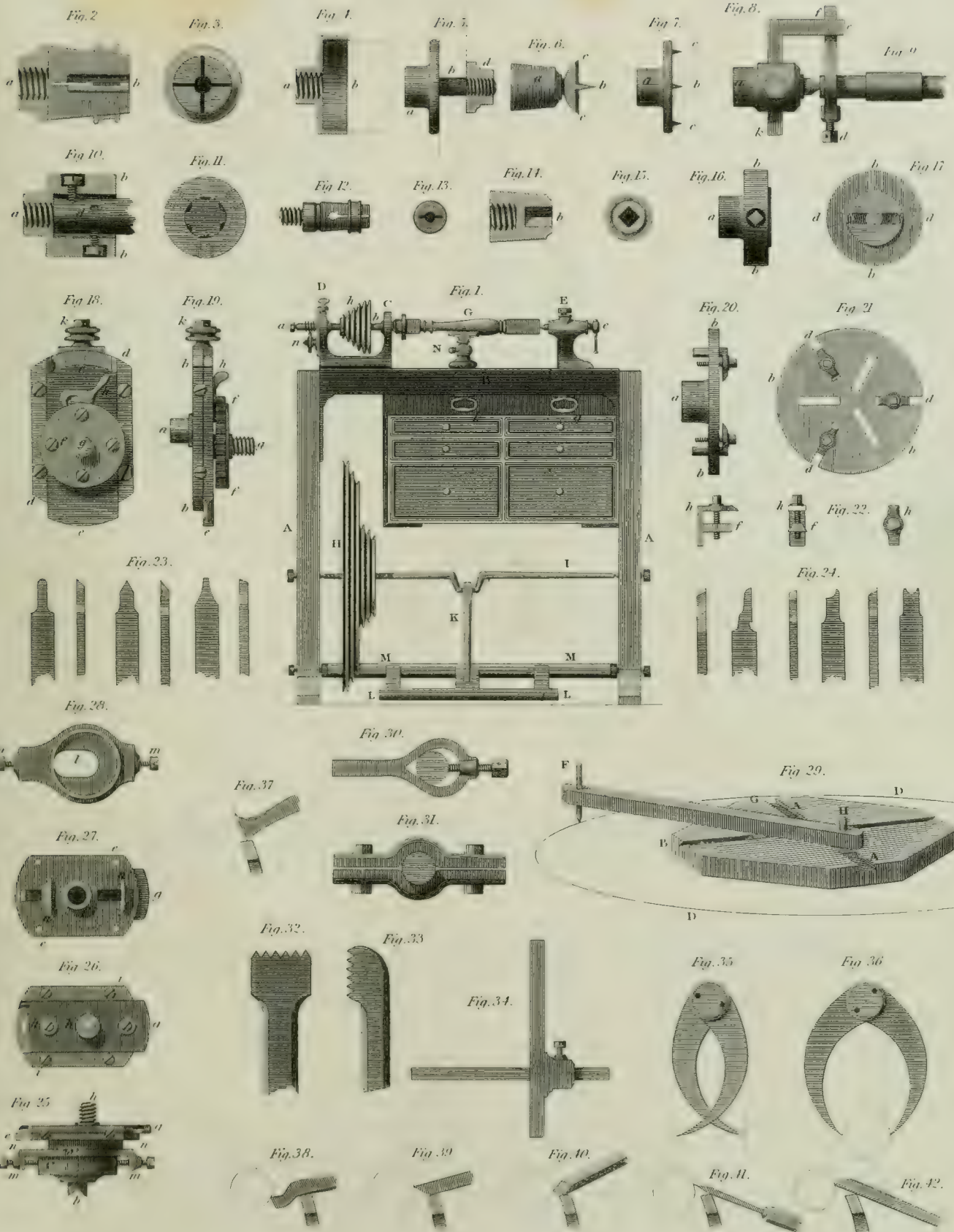
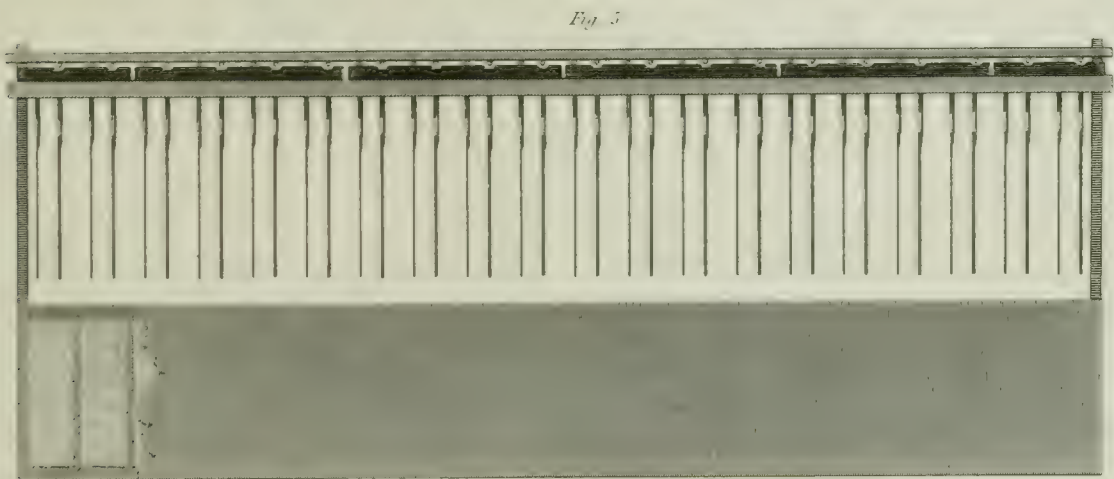
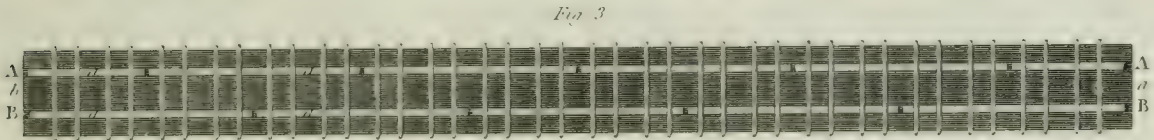
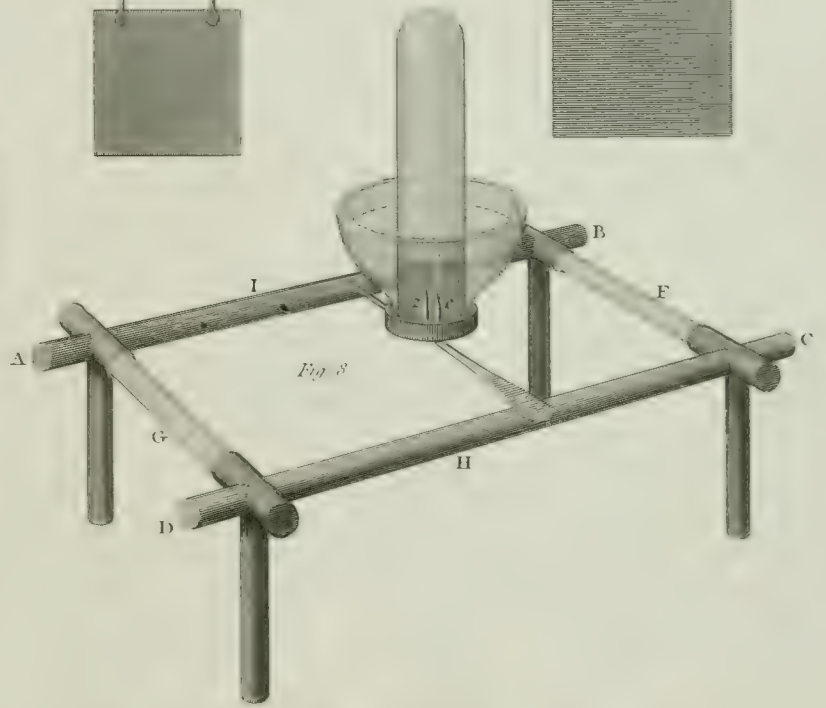
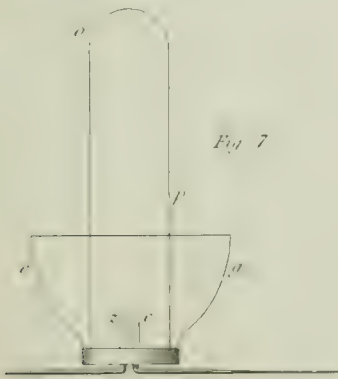
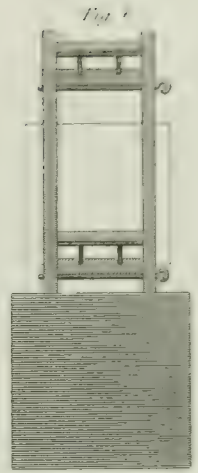
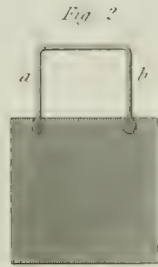
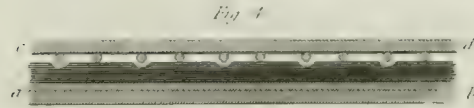
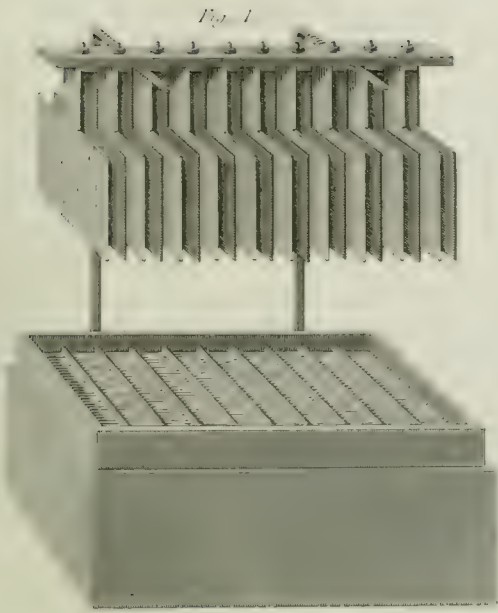

Fig. 22







WATER WHEELS.
OVER SHOT and UNDER SHOT.

Fig. 2.

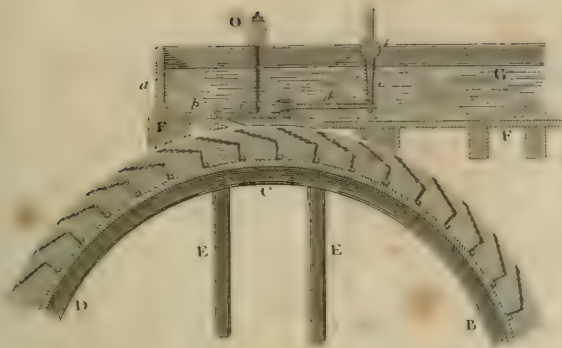

Fig. 1.

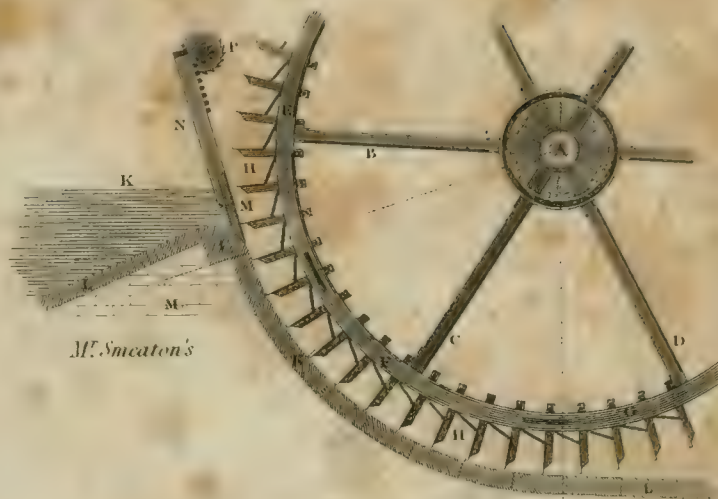

Fig. 4.

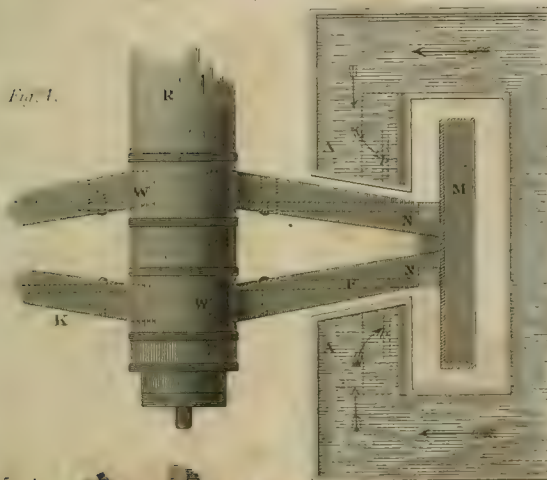

Fig. 3.

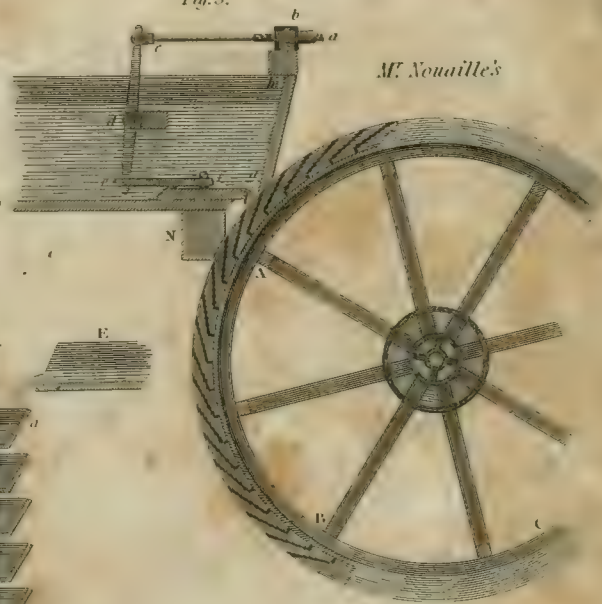

Fig. 6.



Fig. 7.



Fig. 5.



Fig. 8.

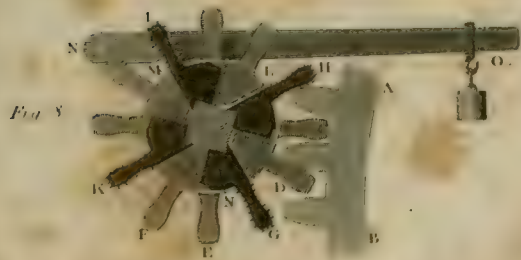



Breast WHEEL with two Shuttles.

Fig. 3.

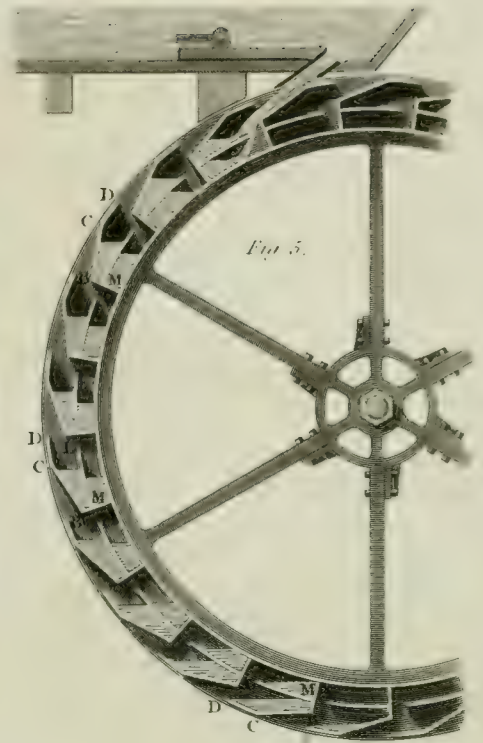
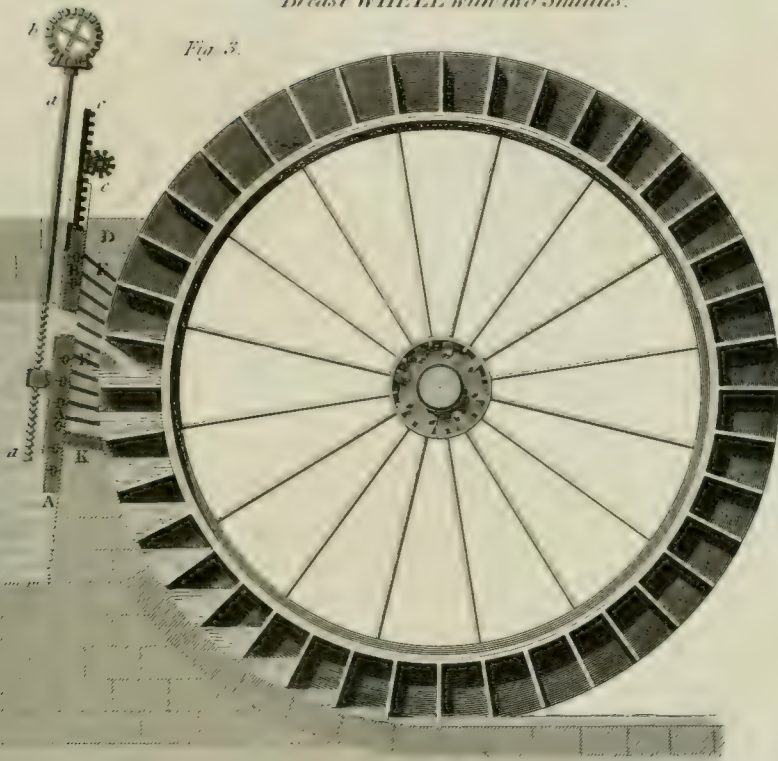
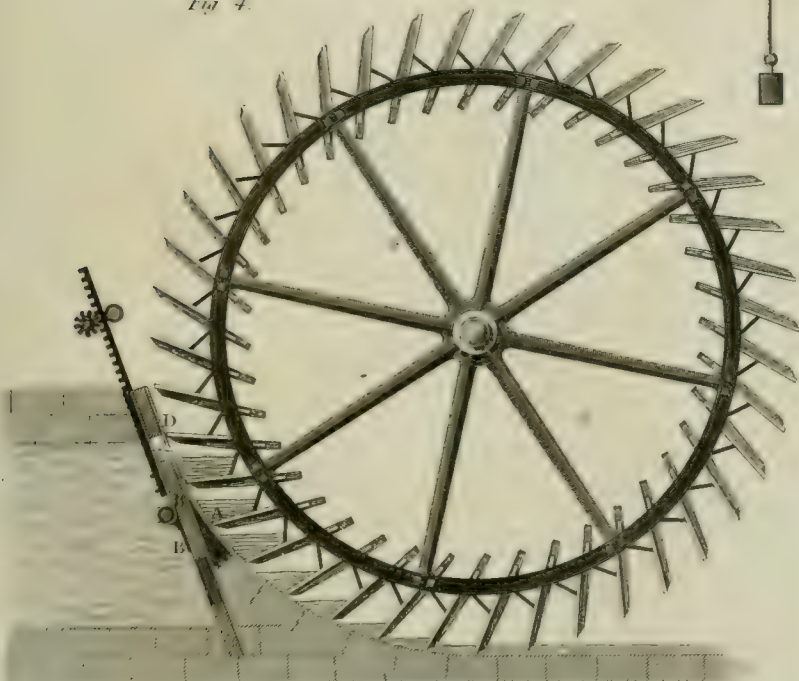

Fig. 5.

Breast WHEEL in which the water flows over the Shuttle.

Fig. 4.



Overshot WHEEL.

Fig. 2.

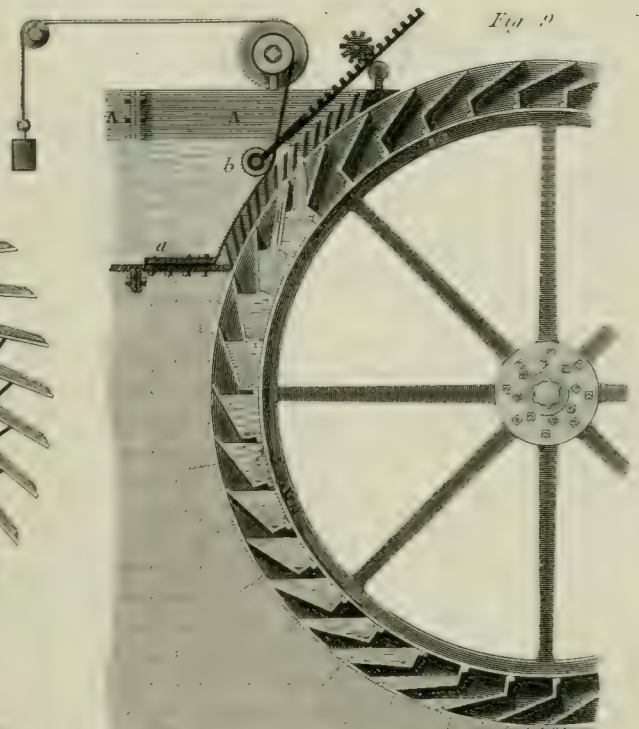

WATER WORKS.

Machines for raising Water.

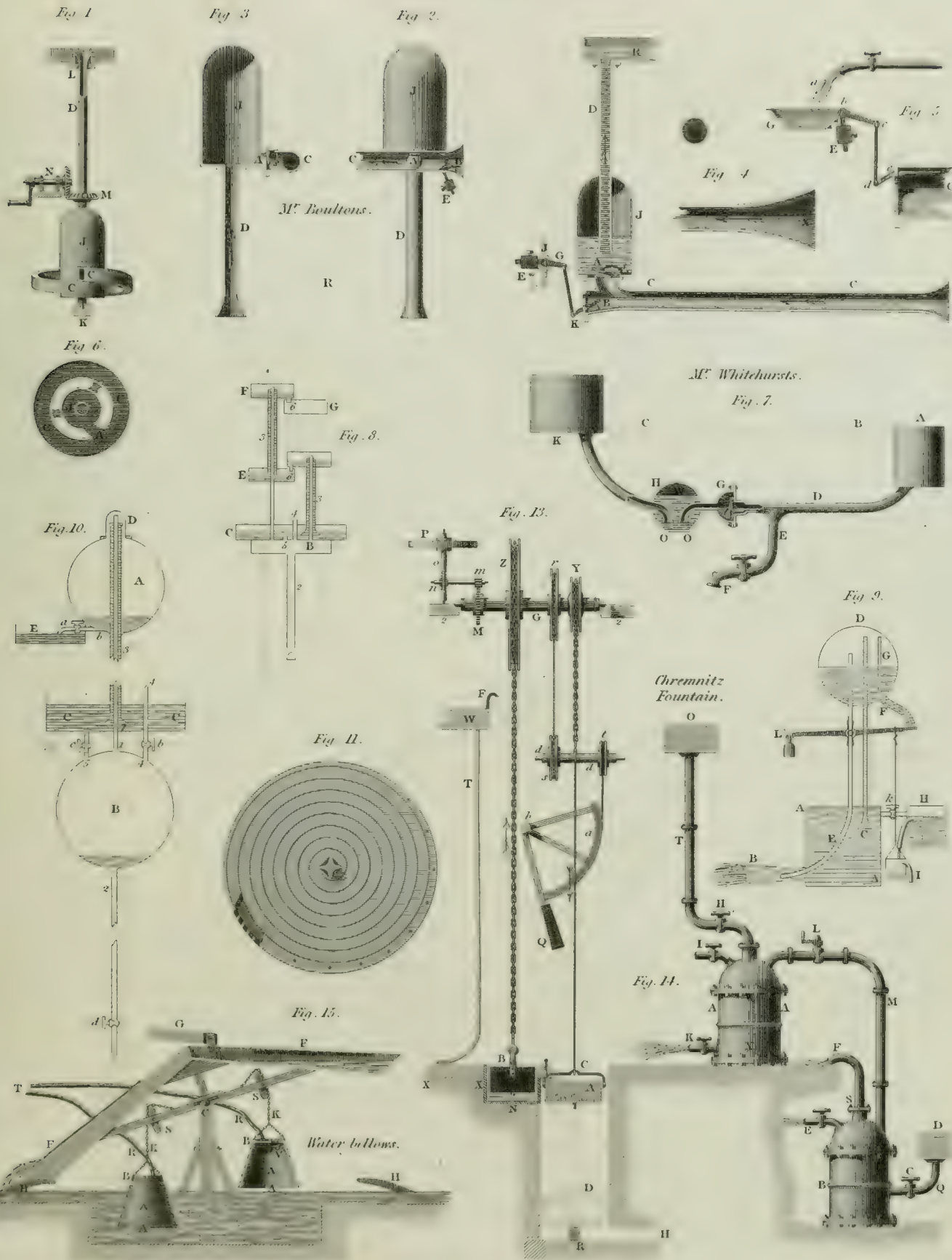

M^r Boultons.

M^r Whitehursts.

Chrennitz Fountain.

Water bellows.

MACHINE for raising WATER at London Bridge.

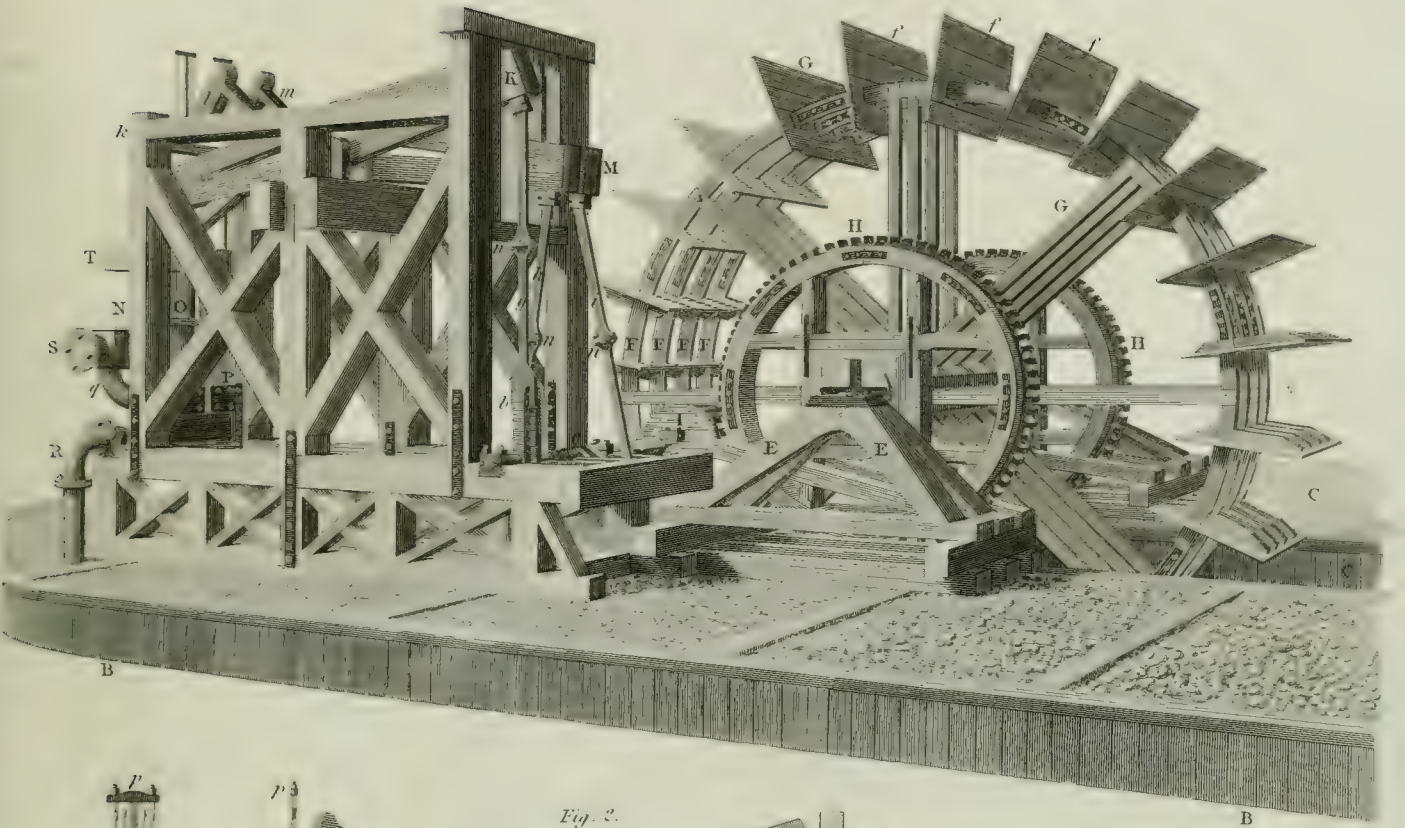

Fig. 2.

ELEVATION of the MACHINES.

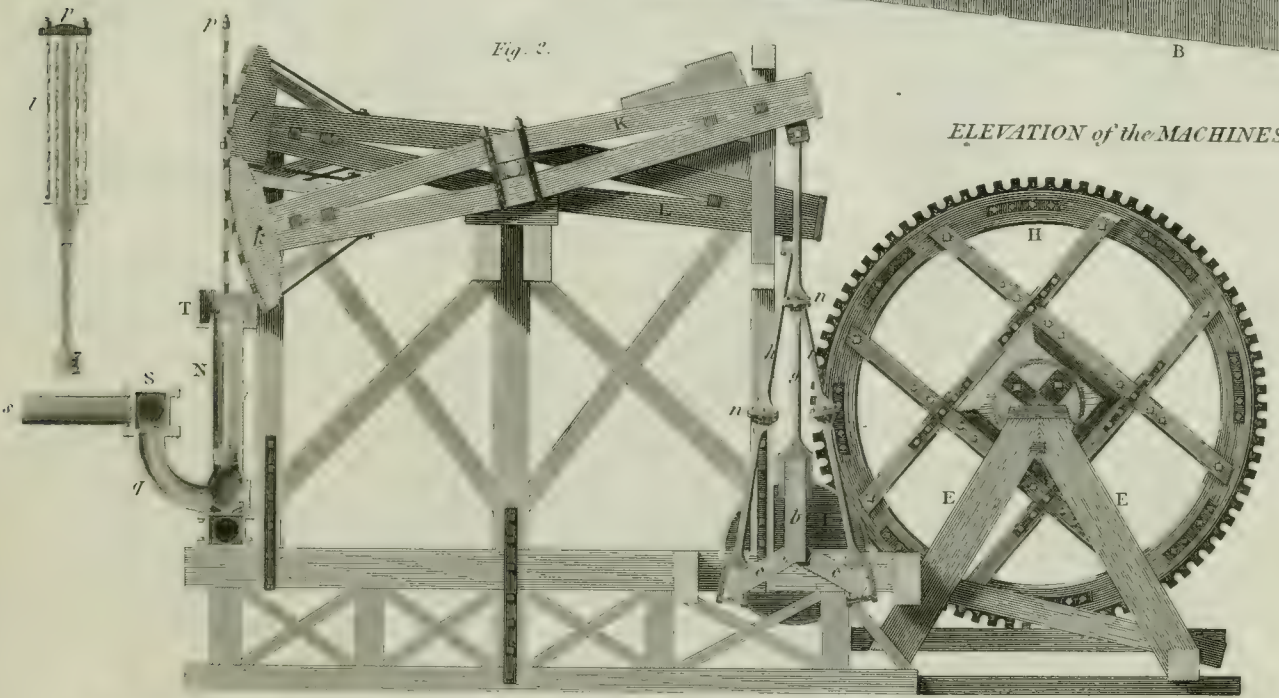
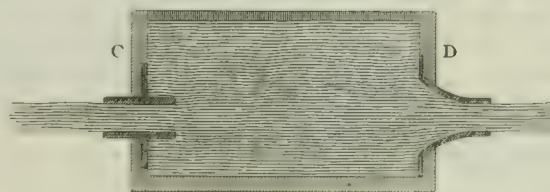
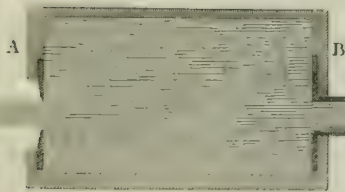

Fig. 8.



M. Austin's Engine Loom.

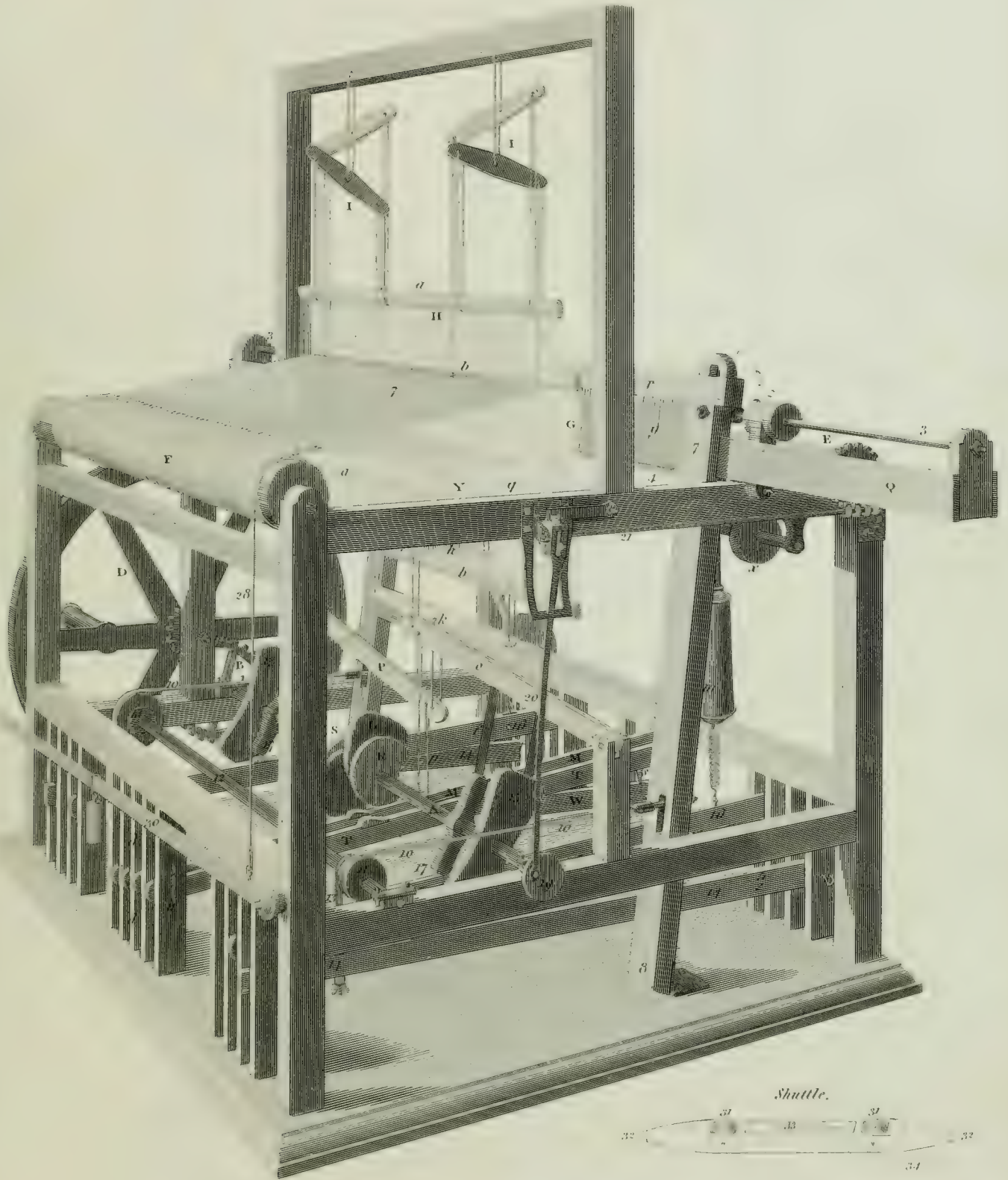

Fig. 2

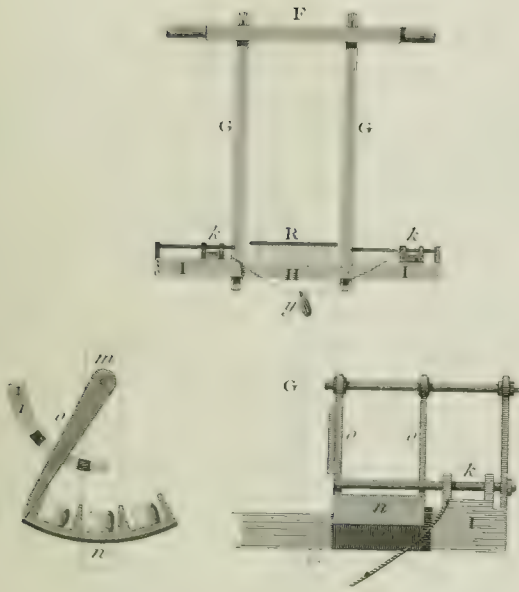
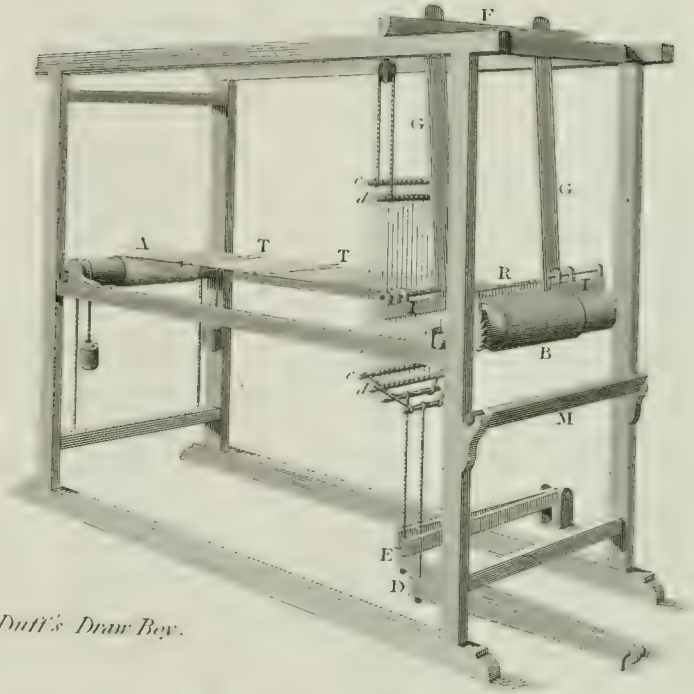

Fig. 3

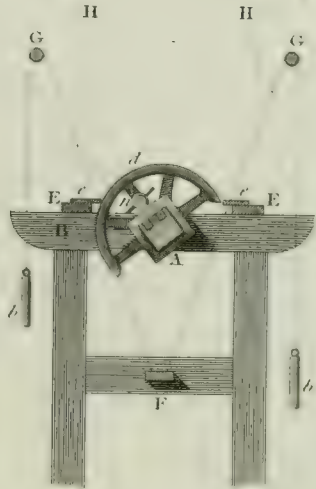
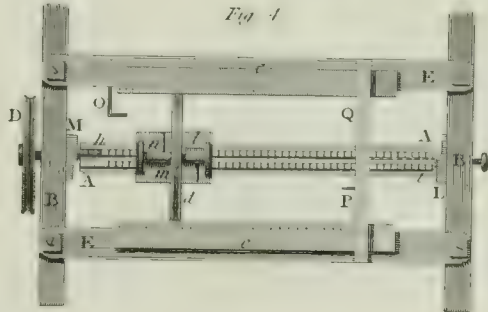

Fig. 1.



Duff's Draw Boy.

Fig. 4



WIND MILL.

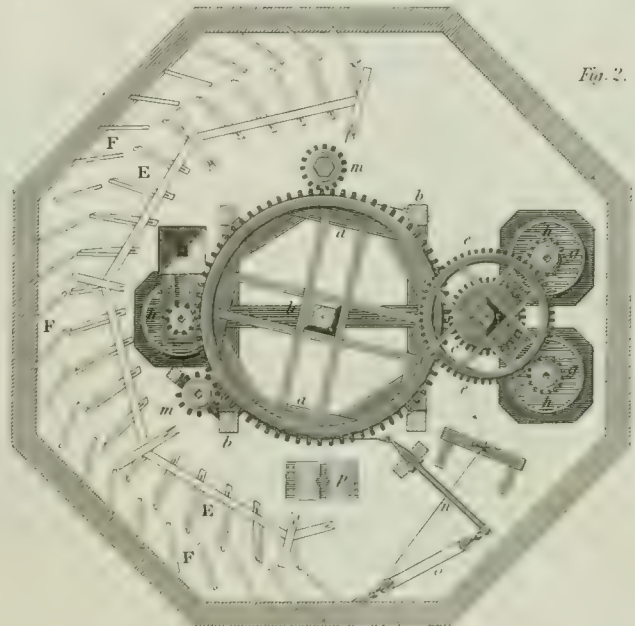
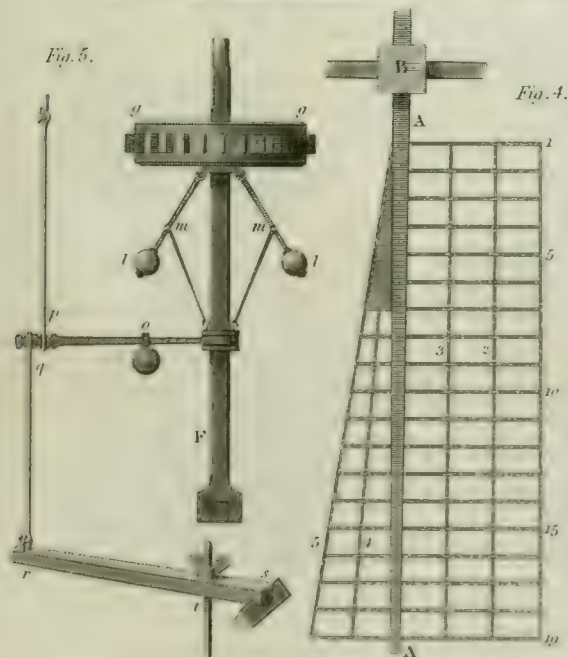
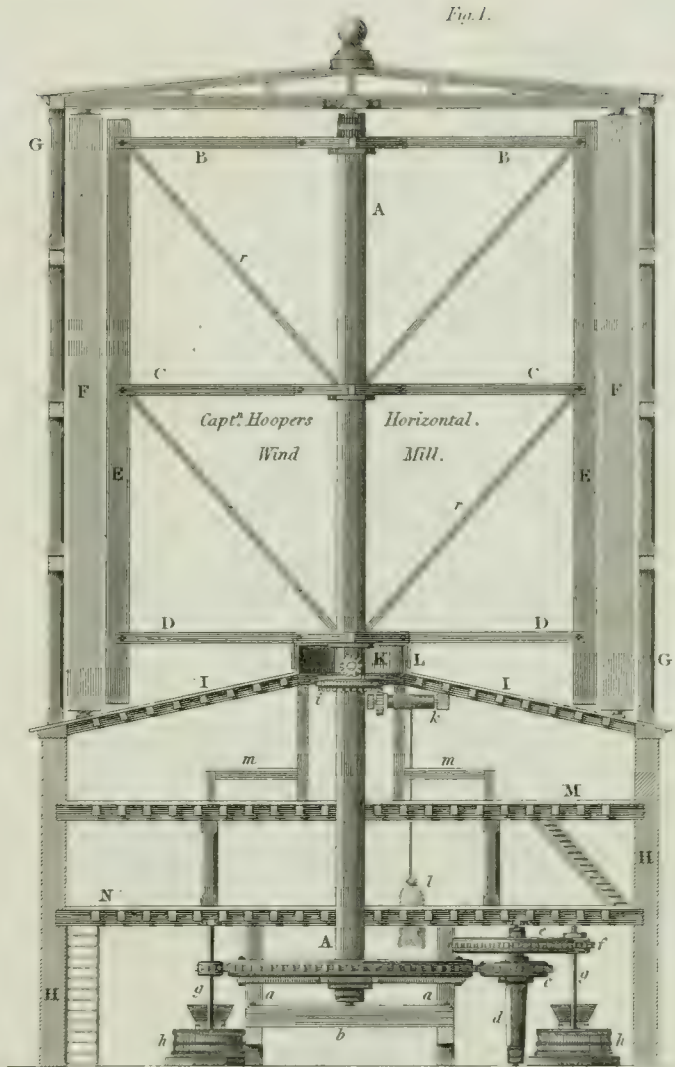
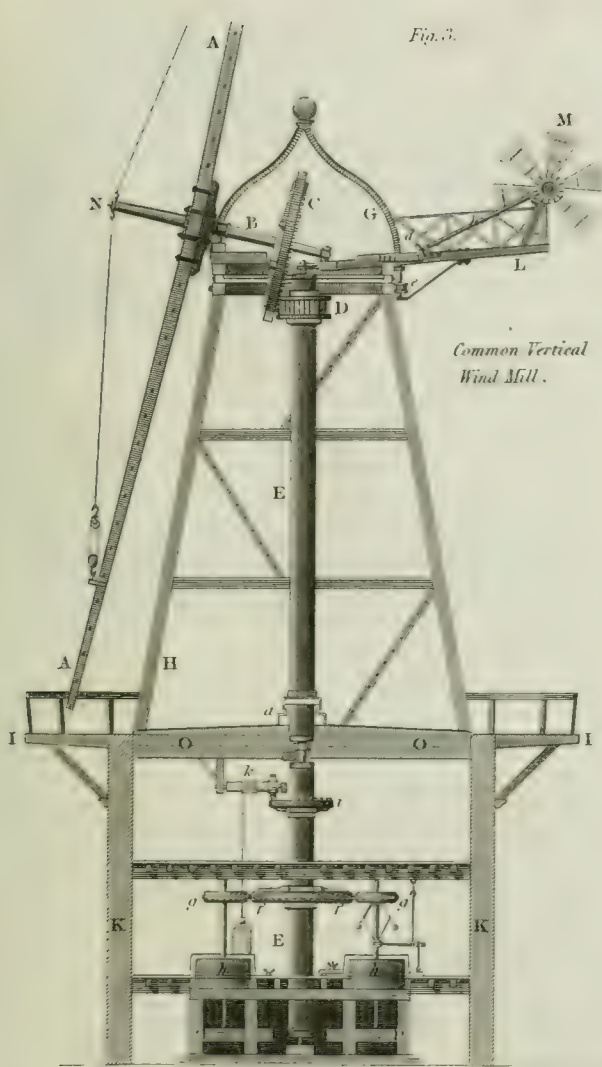

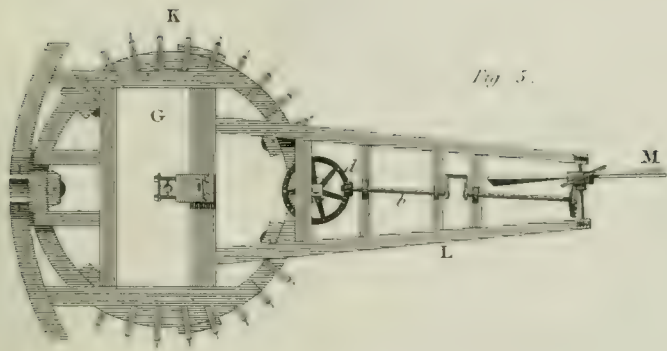

Fig. 5.

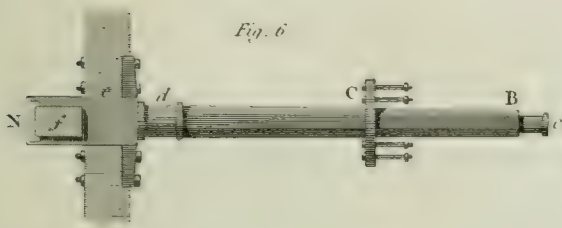

Fig. 6.

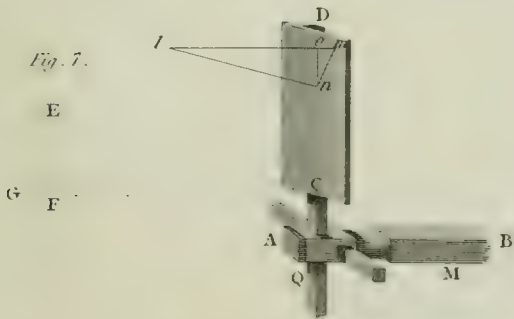

Fig. 7.

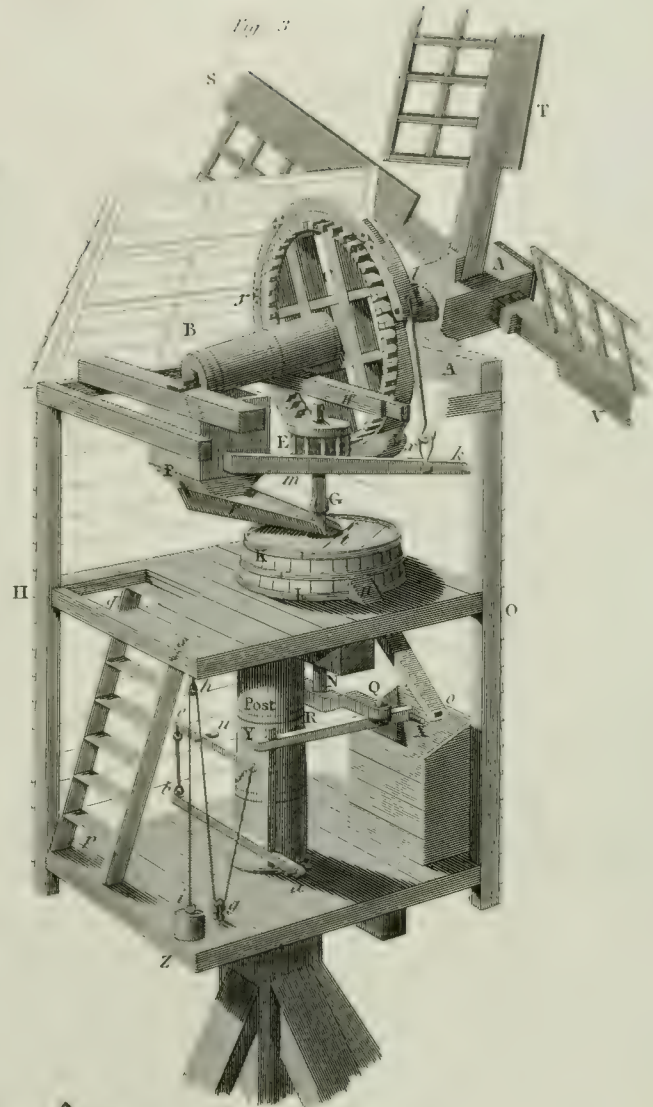

Fig. 3.



Fig. 4.

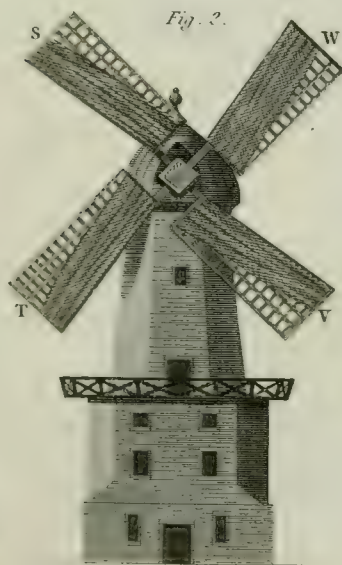

Fig. 2.



Fig. 1.

Mr. Smeaton's design for a Water GIN for drawing Coals from the Pits.

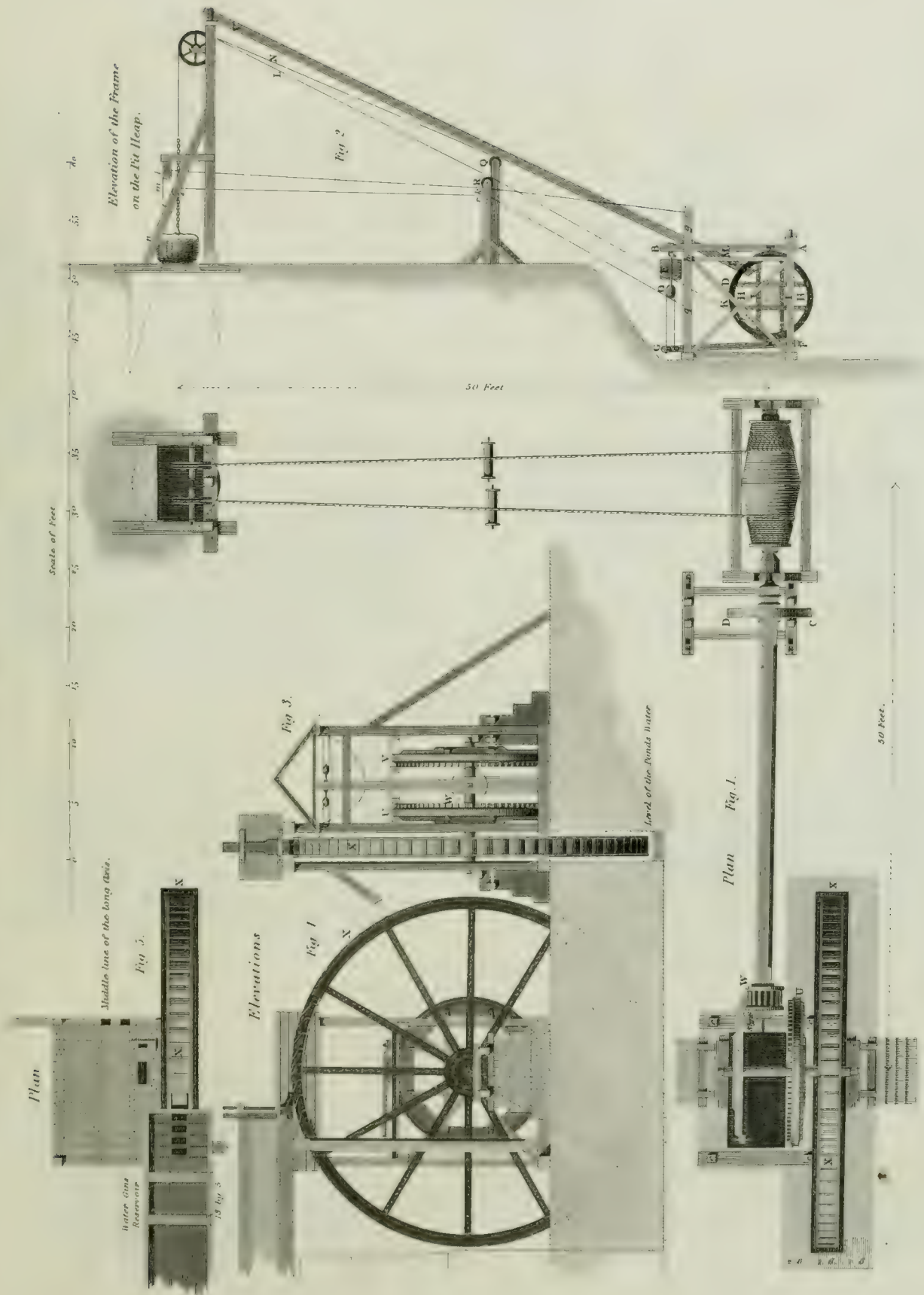

Fig 2

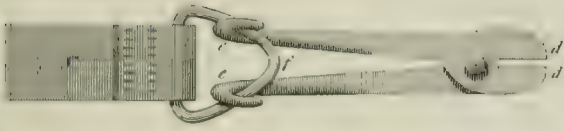

Fig 13.

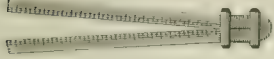

Fig 3

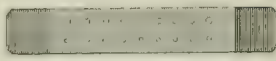

Fig 4



Fig 12



Fig 11

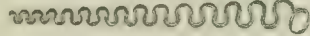

Fig 1

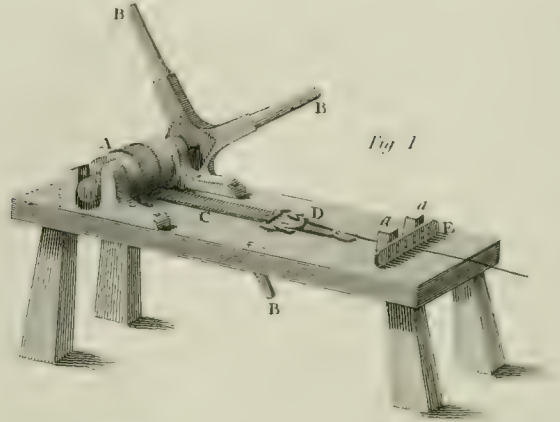

Fig 5.

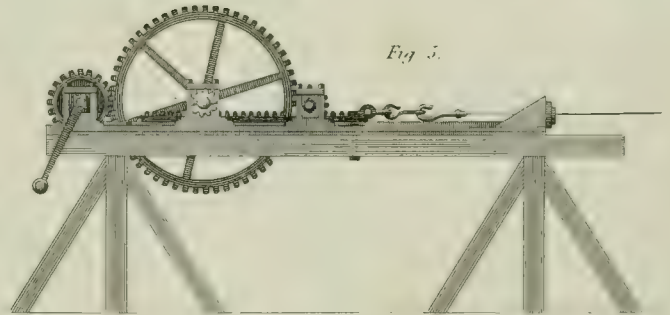

Fig 9

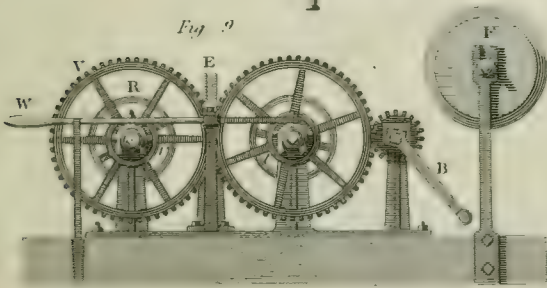

Fig 8

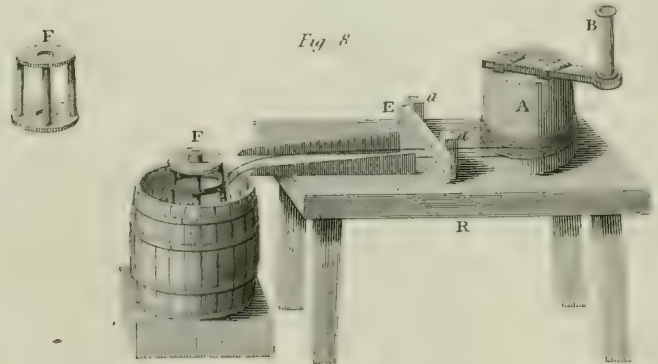

Fig 10

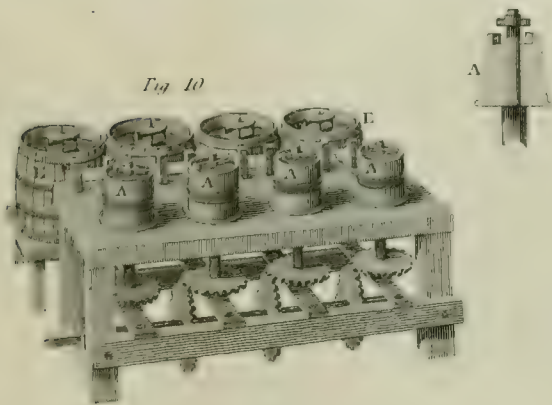
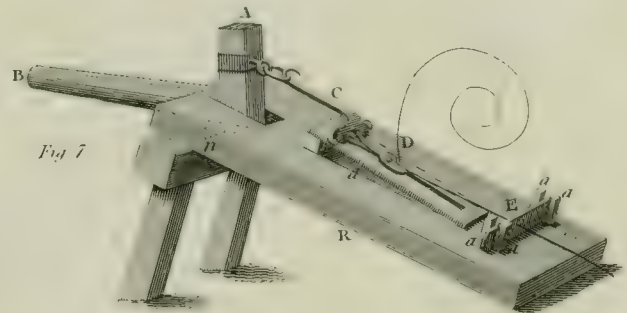

Fig 7



WOOLLEN MANUFACTURE.

SLUBBING MACHINE OR BILLY.

PLATE I.

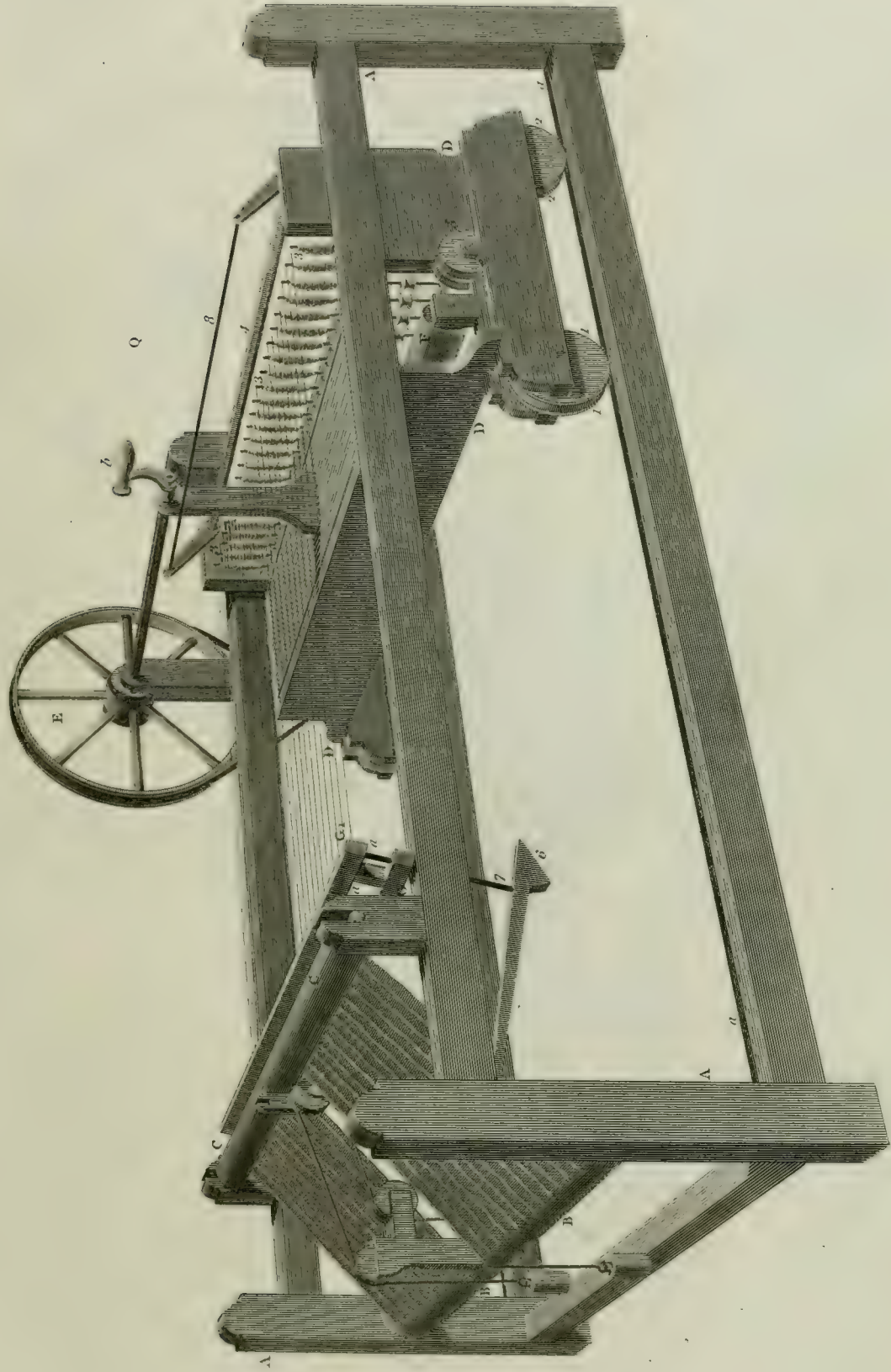

J. Herbert delin.

Published as the Act directs, 1811, by Longman, Hurst, Rees & Orme, Stationers Row.

Engraved by Wilson Leary.

WOOLLEN MANUFACTURE.

SPINNING JENNY.

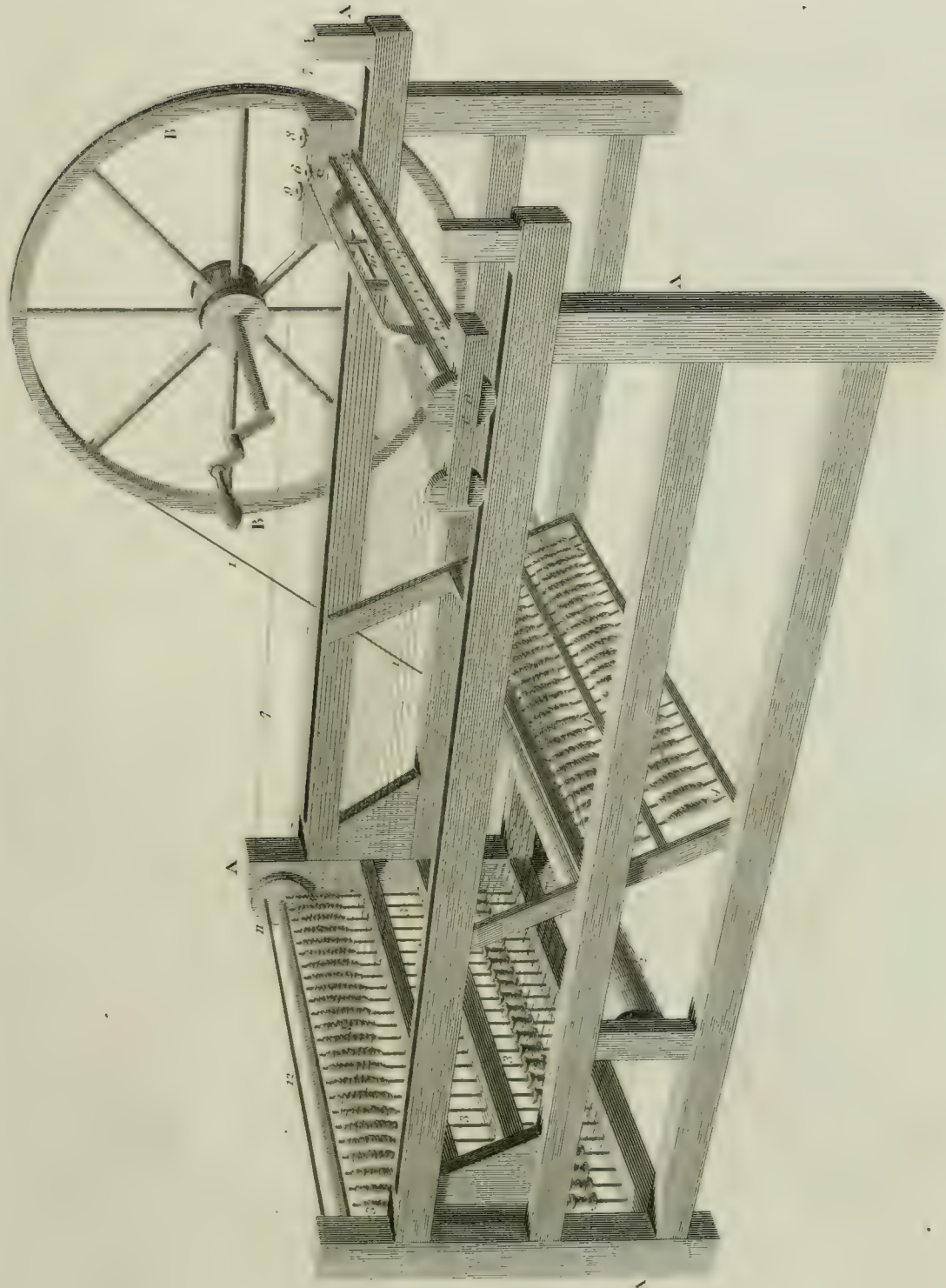

1830

Published at the Office directed, 28, by Longman, Hurst, Ross, Orme, and Brown, Paternoster Row, London

SHEARING MACHINE.

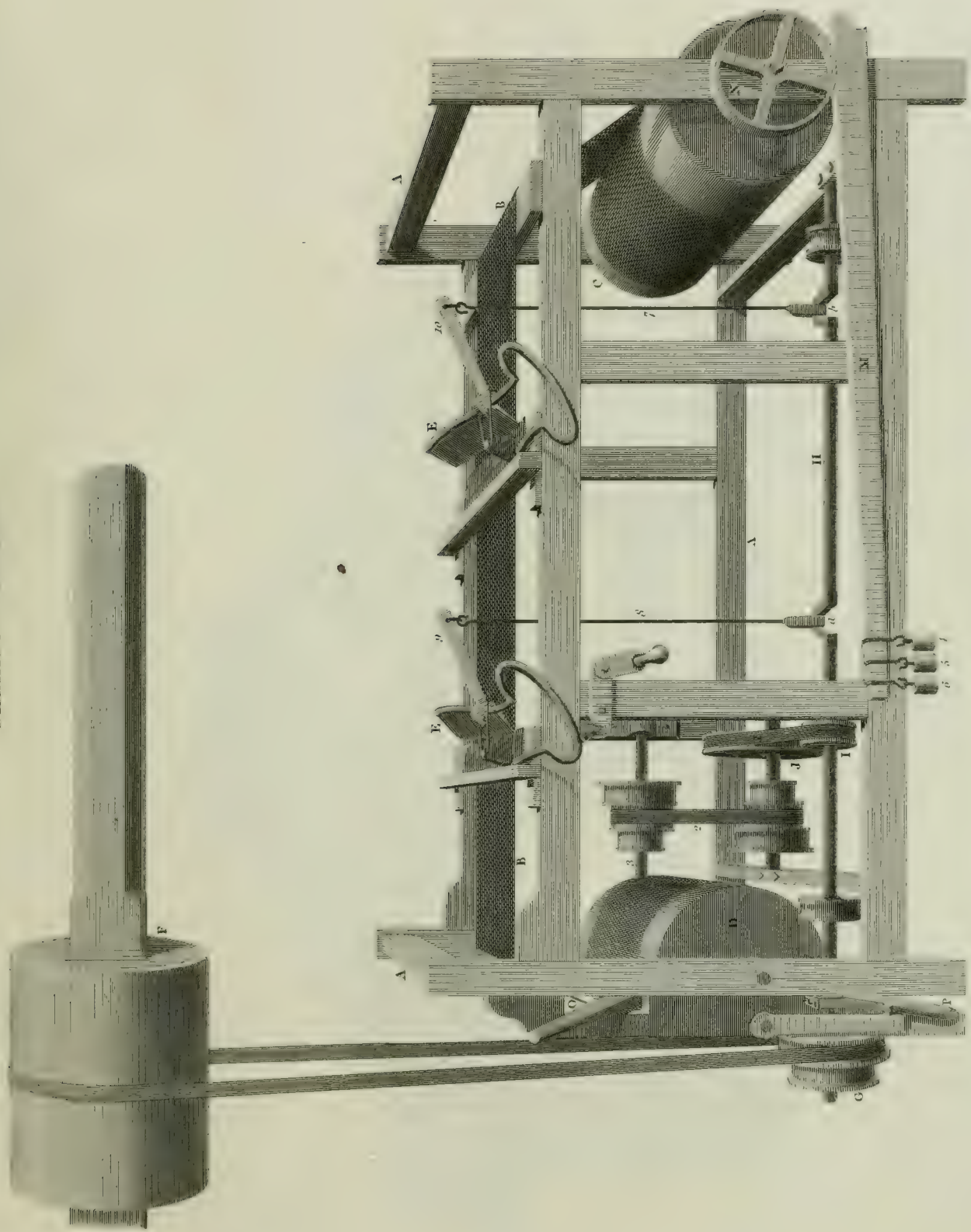

Published as the Act directs, 1851, by Longman, Hurst, Rees, Orme & Brown, Paternoster Row.

Engraved by Wilson-Lowry.

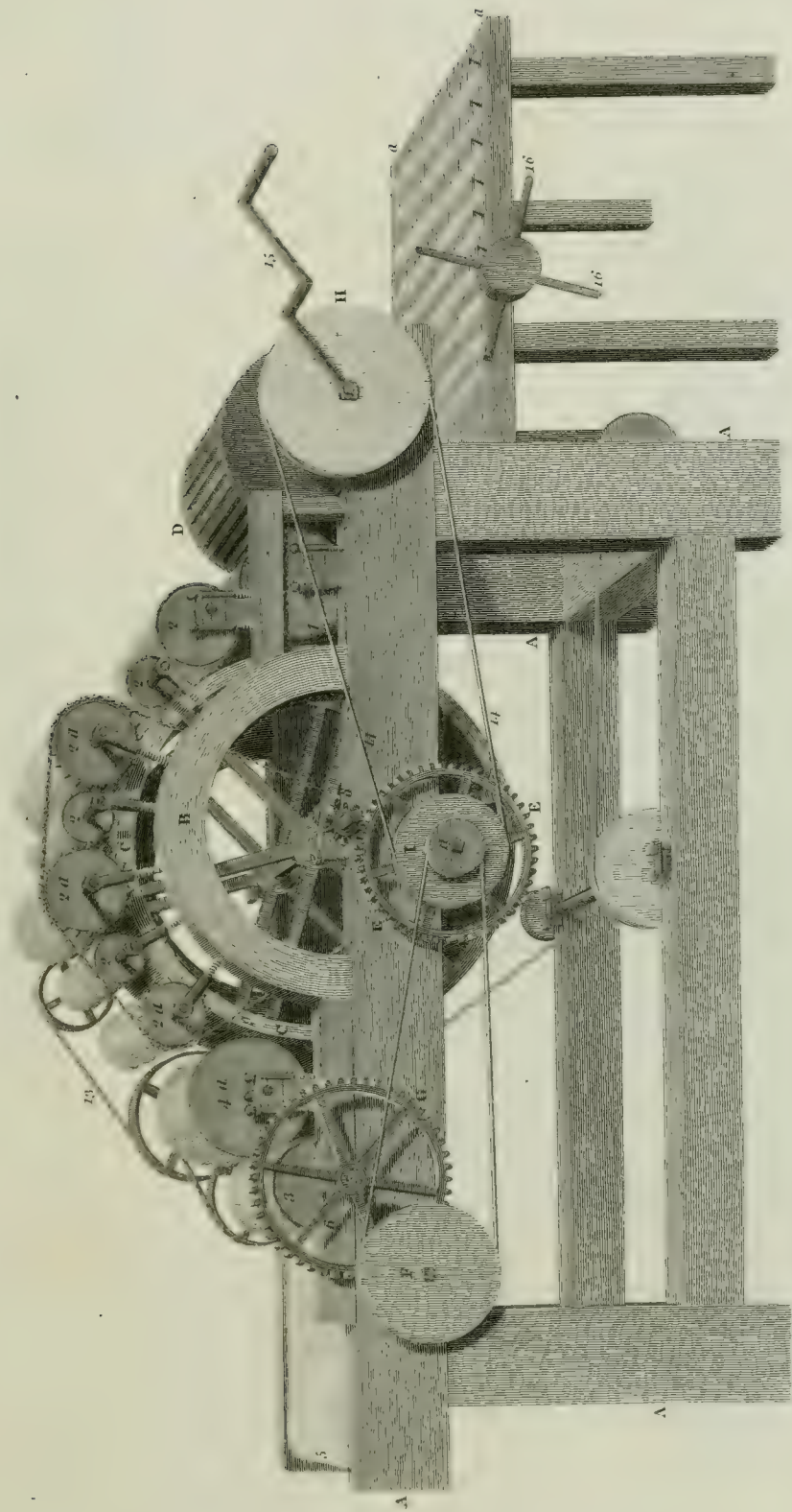

WOOLLEN MANUFACTURE

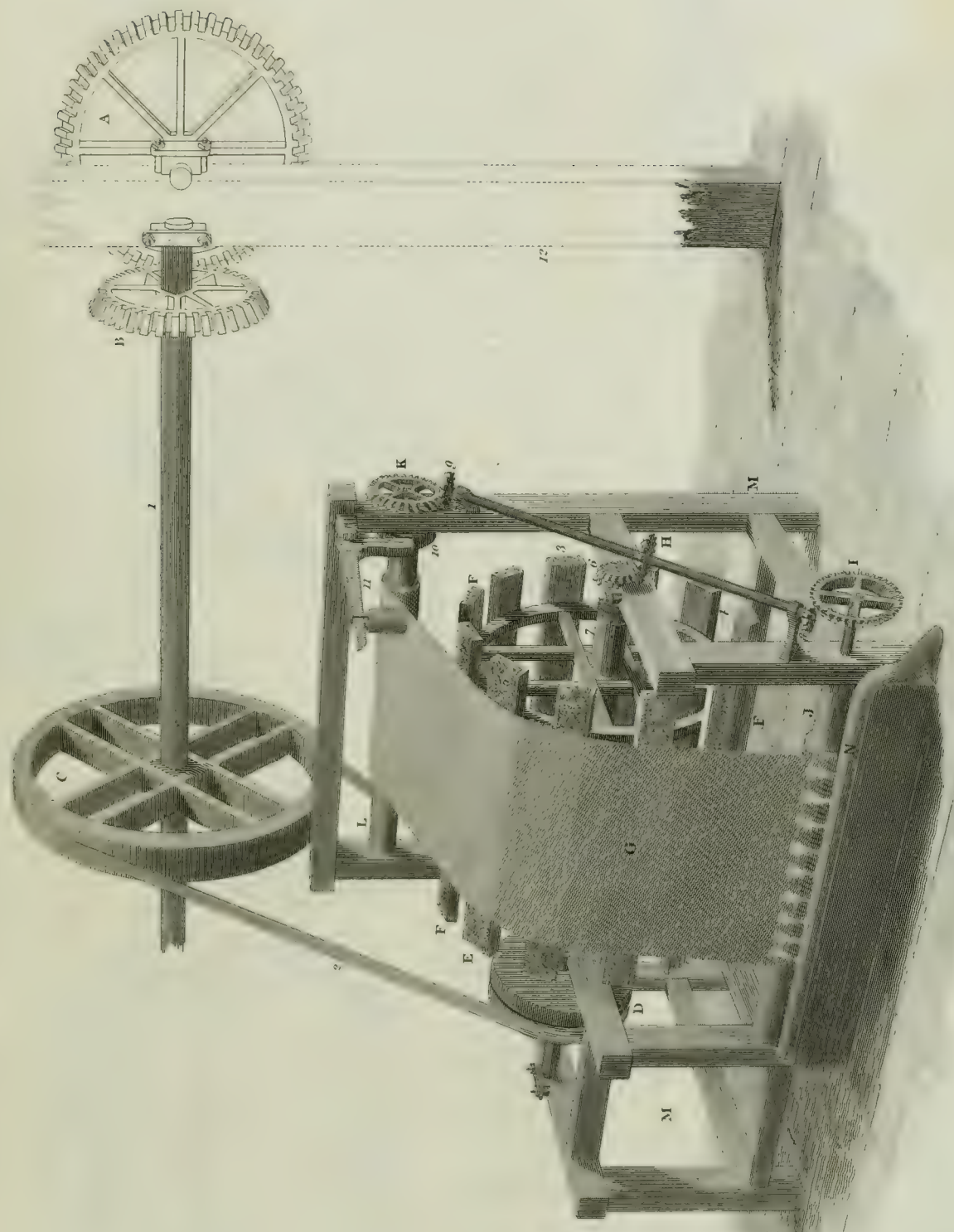

Published as the Act directs, 1855, by Longman, Hurst, Rees, Orme & Brown, Paternoster Row.

Lowry, Sculp.

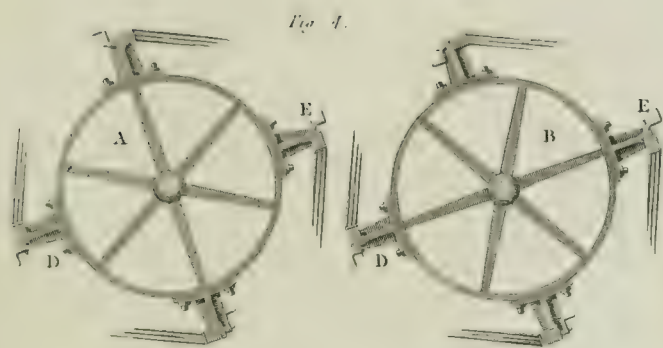

BREAKING Frame.

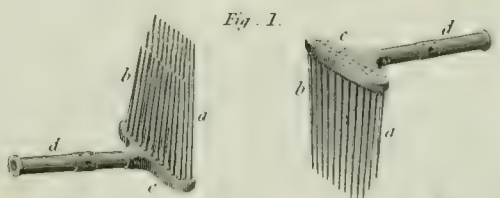
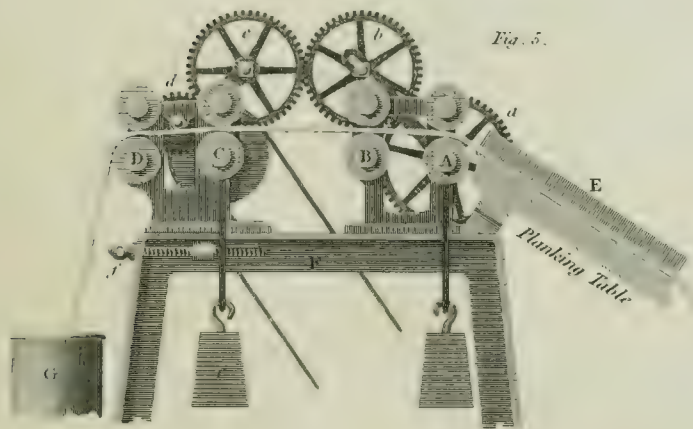
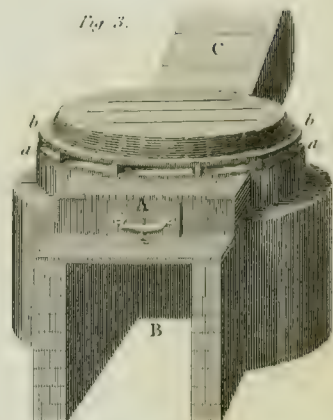
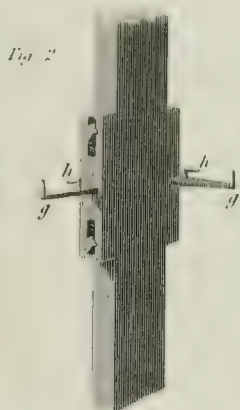

SPINNING Frame.

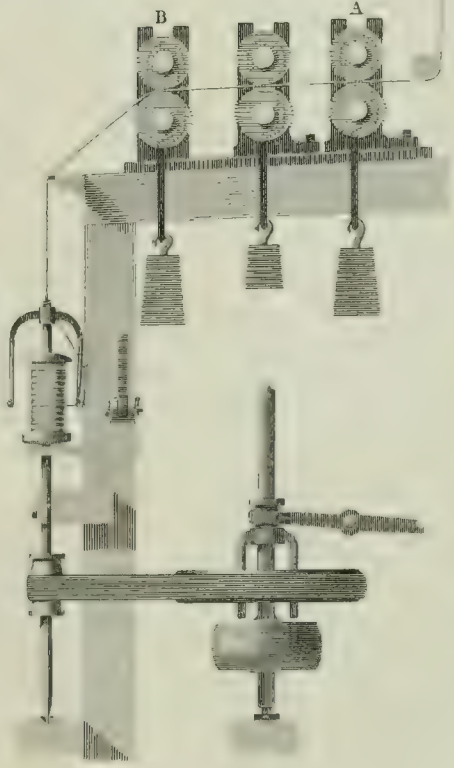
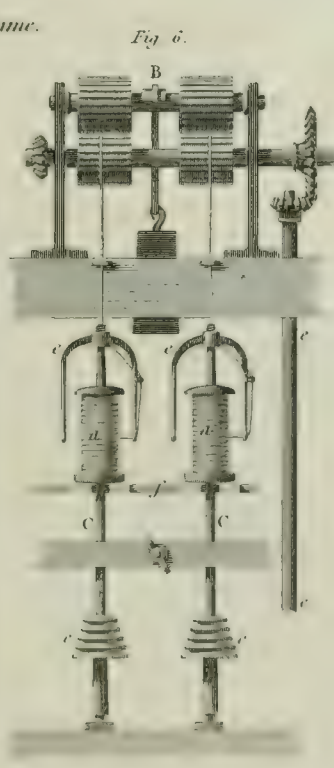
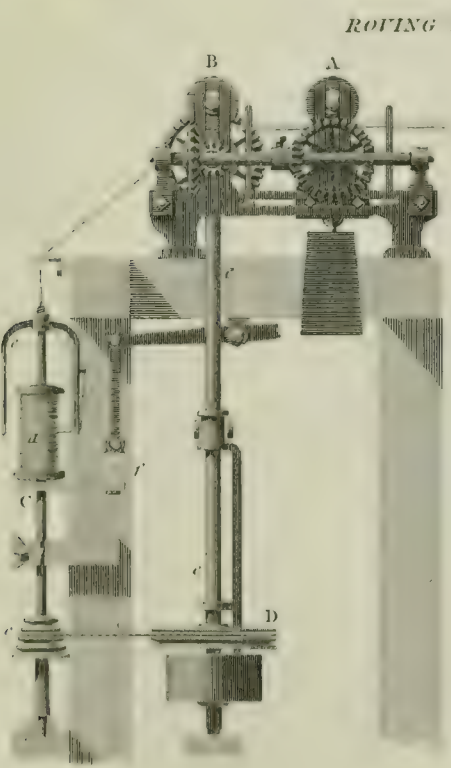

WORSTED MANUFACTURE.
 CARTWRIGHT'S COMBING MACHINE.

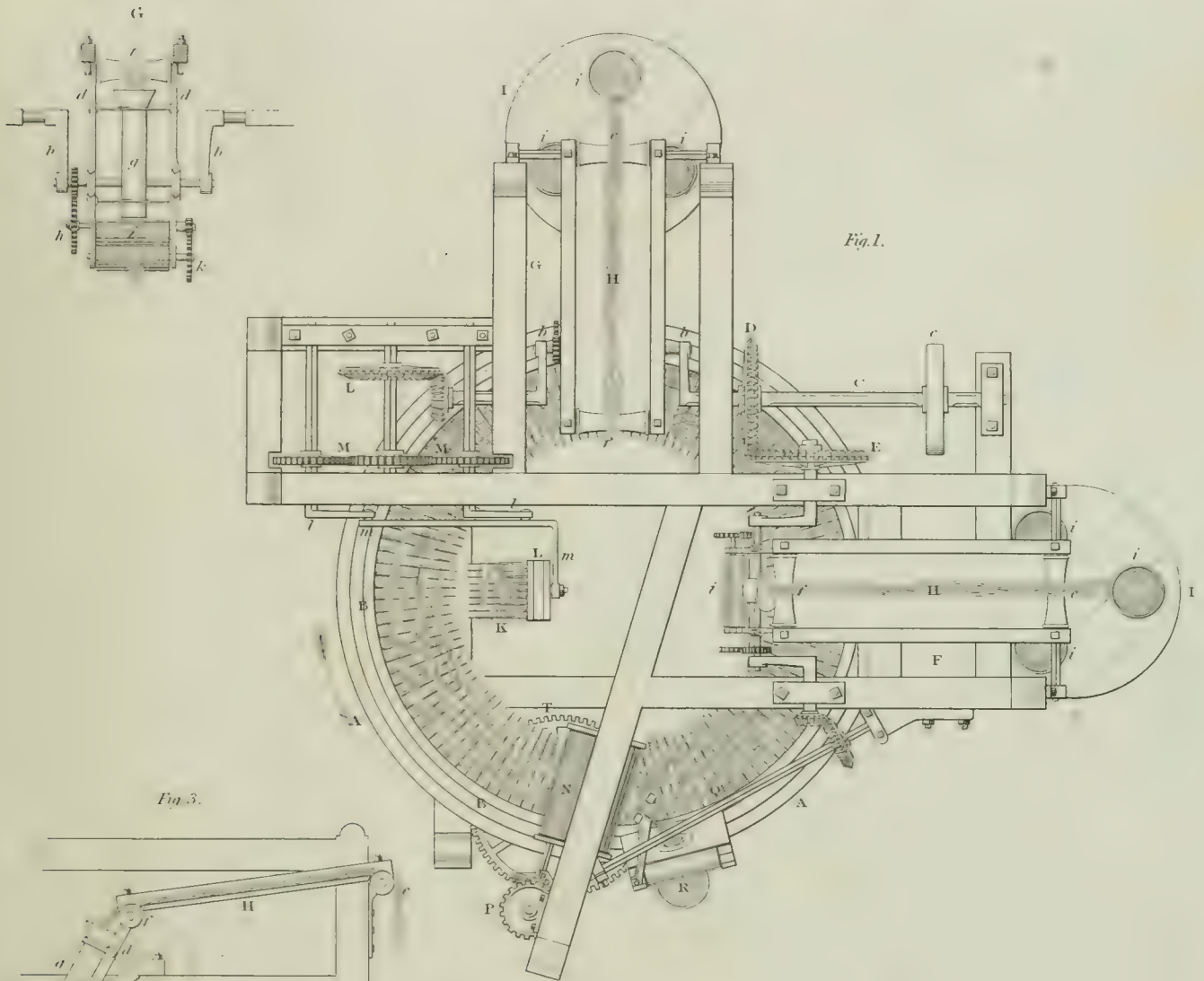

Fig. 1.

Fig. 3.

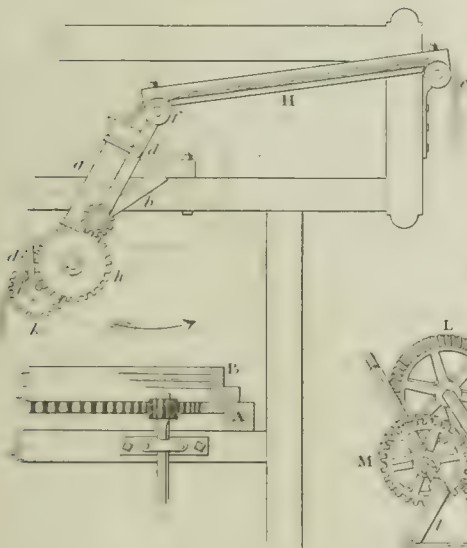
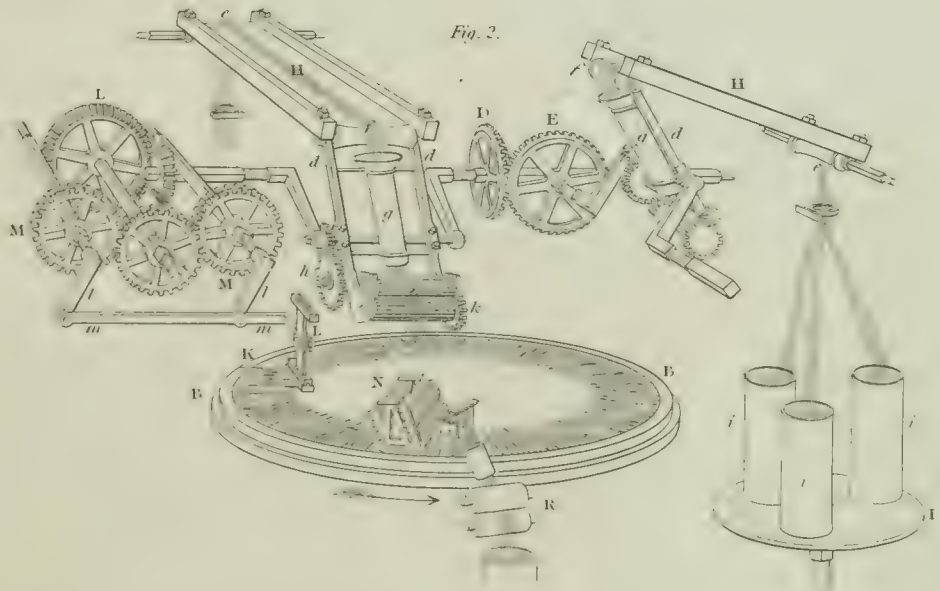

Fig. 2.



WRITING BY CIPHER.

z	i	ƒ	κ	π	co	h	p	λ	m	q	π	π	Γ	υ	v	Δ	γ	ψ	7	6	2	φ	ψ	Ψ
a	b	c	d	e	f	g	h	i	k	l	m	n	o	p	q	r	s	t	u	v	w	x	y	z

b	l	f	s	n	h	d	t	e	g	m	g	ny	y	r	a	o	u	e	a	o	oi	ui	io	oo
I	II	III	IIII	IIII	I	II	III	IIII	IIII	I	II	III	IIII	IIII	I	II	III	IIII	IIII	X	O	o	#	∞

a	b	c	d	e	f	g	h	i	k	l	m	n	o	p	q	r	s	t	v	w	x	y	z	
○	○	○	○	○	○	○	○	○	○	○	○	○	○	○	○	○	○	○	○	○	○	○	○	○

It is high time on his Majesty and my behalfe with his grace's condisque thanks and my most humble recommendations, you plainly show and declare unto the Emperour, what hindrance hath ensued, and daily doth, unto the common affaires by reason things, &c.

IO u x x h d - - h u x u 1 - - u i - - h f u = h f . d x σ # τ = u - h = x z + p
 - - u f - - u λ i δ x u 1 = d λ f ε d δ u u ζ = ε x 4 u λ τ = u = d λ f
 - - = - z h σ h ε d = = h x // ζ u d x λ u h s = ζ u x h z u λ = h - - τ h

The talk between me and the Gen^{le} of that Marriage wch I adventure
 It may please your Majesty should trouble both your, the^{le} and them twice I wrote gave me
 6.7.5.9. ω s. ζ ξ 2 : 6.7.++ u 4 ≠ 7 2 : ω : γ θ τ κ and 6.7.2 : L 6. π 2 : 4 q m
 occasion of nature suspicious I thought somewhat there was otherwise such
 7 x γ π 9. 4 7 4. 7 δ o γ δ . L 7 . ∞ ω ο π 6 . 2 : ω L 7 γ f f π 10 . π δ ε β ο .
 4 π 2 : s : 7 . 4 10 . 6 : 9 10 4 x π 7 s : 10 π 4 : ω 7 s : x ω 4 : β β 7 . φ π 10 . W . b g s :

The new Emperour by his Ambassadour here
 I wish with all the new men forwards
 ω η : δ : 3 4 0 3 η 9 π ο : 9 β λ γ σ ο ω λ 3 : 4 : z ο κ ο : 9 ω η η 9 3
 v ω 4 : 7 : s ω 4 η γ . 4 L ω ω η t
 ο η ω + κ 9 : 8 : 2 9 ο 3 :
 to a direct resolution touching these Marriage
 T ο s 9 ζ z w

he desired that thousand shall would else
 the somme be increased to nine
 ω λ δ π η ο - - ο δ mought 4 6 x h e δ ⊕ δ π 6 ω to h e x h e
 ω λ η π ω h η ω shall manie things, and places of importance
 I δ ω δ β π ρ λ ο I η ⊕ ω h η δ β
 D δ η η δ ω δ δ ω x δ β γ η ⊕ ω π ο - - ω δ β ω λ x h η β δ
 for a smaule thing

WRITING BY CIPHER.

1

a b c d e f g h i j k l m n o p q r s t u v w x y z

2

t a c t o u s t u r y e q k w b f e d m p h y z

3

n i a r y o n d e r e o p s u h e r e n e c t h e g a r d e n s m i t l e d
a u d s t i l l w h e r e m a n y a g a r d e n f l o w e r g r o w s w i l d

4 Lento

t h a t o f l o r i l
e x p e r e s s e d
j u n t h e s
s a r t n u m b e r
l e t m e k n o w y o u a r e s a f e a
u n d e a s e m y t o r t u r e d m i n d

6

i m p e r i t i a . e t . t u s e t t a . s e c e r
e t a r i o r u m . e t . a m a n u e u s t u m .
i u . a u t a s . p r i n e i p u m . t a u t a .
e t . t . m a x i m a . p l e r u n q u e . u
e g i t a . e a p h r i s . i u t i r m i s . e
t . t u t i i b u s . e o m m i t t a u t a r .

WRITING BY CIPHER.

Alphabet and Key.

b	e	s	m	t	l	i	c	o
q	m	l	p	u	h	o	i	a
j	p	u	d	u	n	h	o	e
k	d	y	f	e	r	n	s	t
g	r	a	l	i	s	r	t	o
v	l	e	h	o	t	s	u	a
w	h	i	n	e	u	t	a	e
x	n	o	r	d	a	u	e	i
z	r	o	s	t	e	a	i	o

H. Blair inv. 1807.

The page contains 20 horizontal lines for handwriting practice. Each line is a five-line staff with a series of dots placed on the lines to represent the cipher alphabet. The dots are arranged in a regular pattern across the page, providing a guide for the placement of letters in the cipher system.

AE
5
R329

Rees, Abraham
The cyclopaedia

Plates
v.4



PLEASE DO NOT REMOVE
CARDS OR SLIPS FROM THIS POCKET

UNIVERSITY OF TORONTO LIBRARY

UTL AT DOWNSVIEW

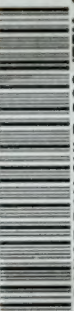

D RANGE BAY SHLF POS ITEM C
39 14 10 17 07 005 0